ABB DRIVES FOR WATER

ACQ580 Pump control program

Firmware manual



Related documents are listed on page [15](#).



Table of contents

ACQ580
Pump control program
Firmware manual

1. Introduction to the manual

2. Start-up, control with I/O and ID run

3. Control panel

4. Settings, I/O and diagnostics on the control panel

5. Default I/O configuration

6. Program features

7. Fault tracing

8. Fieldbus control through the embedded fieldbus interface (EFB)

9. Fieldbus control through a fieldbus adapter

10. Control chain diagrams

11. Parameters

12. Additional parameter data

3AXD5000035867 Rev E
EN
EFFECTIVE: 2020-09-14



Table of contents

1. Introduction to the manual

Contents of this chapter	13
Applicability	13
Safety instructions	13
Target audience	14
Purpose of the manual	14
Contents of this manual	14
Related documents	15
Cybersecurity disclaimer	20

2. Start-up, control with I/O and ID run

Contents of this chapter	21
How to start up the drive	22
How to start up the drive using the First start assistant on the Hand-Off-Auto control panel	22
How to control the drive through the I/O interface	28
How to perform the ID run	29
ID run procedure with the ID Run assistant	30

3. Control panel

Contents of this chapter	35
Removing and reinstalling the control panel	35
Layout of the control panel	36
Layout of the control panel display	37
Home view displays	40
IPC and Level control additional Home view displays	41
Keys	42
Key shortcuts	43

4. Settings, I/O and diagnostics on the control panel

Contents of this chapter	45
Primary settings	46
Assistants	47
Start, stop, reference	49
Motor	51
Pump features	53
PID control	55
Multipump control	57
Ramps	60
Limits	61
Fieldbus	62
Fault functions	66



6 Table of contents

Security	67
Advanced functions	68
Clock, region, display	70
Reset to defaults	72
I/O menu	74
Diagnostics menu	76
System info menu	78
Energy efficiency menu	79
Backups menu	81
Options menu	81

5. Default I/O configuration

Contents of this chapter	83
Water default	84

6. Program features

What this chapter contains	87
Local control vs. external control	87
Local control	88
External control	89
Operating modes of the drive	90
Drive configuration and programming	91
Configuring via default configurations	91
Configuring via menus	91
Configuring via parameters	91
Adaptive programming	92
Control interfaces	95
Programmable analog inputs	95
Programmable analog outputs	95
Programmable digital inputs and outputs	95
Programmable frequency input and output	95
Programmable relay outputs	95
Programmable I/O extensions	96
Fieldbus control	96
Control of a line supply unit (LSU)	97
Pump control features	99
Intelligent pump control (IPC)	99
IPC master autochange	103
Application example: IPC system with three drives and three pumps	106
Single pump control (PFC/SPFC)	112
Level control	119
Soft pipe fill	121
Sensorless flow calculation	121
Pump cleaning	124
Dry pump protection	127
Pump inlet and outlet protection	127
Ramps – Quick ramps	128
Automatic fault resets	131
External events	131



Constant speeds/frequencies	131
Critical speeds/frequencies	132
Timed functions	133
Ramps	135
Overview	135
Functionality	135
Process PID control (PID/Loop controller)	137
Limits	140
Limits overview	140
Interlocks	141
Overview	141
Configuration	141
Wiring connections	142
Functionality	142
Run permissives	143
Overview	143
Configuration	143
Wiring connections	143
Functionality	144
Application example 1: Valve opening	144
Motor control	145
Frequency control mode	145
Scalar motor control	145
Speed control mode	146
Vector motor control	146
Autophasing	147
Motor types	148
Motor identification	148
U/f ratio	148
Flux braking	149
Start methods – DC magnetization	150
Switching frequency	152
Motor thermal protection	152
Motor overload protection	159
Speed control performance figures	161
Torque control performance figures	161
Motor potentiometer	162
DC voltage control	167
Overvoltage control	167
Undervoltage control (power loss ride-through)	167
Voltage control and trip limits	168
Brake chopper	172
Supervisory	173
Signal supervision	173
User load curve (Condition monitoring)	173
Energy efficiency	175
Energy optimization	175
Energy saving calculators	175
Load analyzer	176
User parameter sets	177
System safety and protections	178



8 Table of contents

Fixed/Standard protections	178
Programmable protection functions	178
Emergency stop	179
Diagnostics	181
Diagnostics menu	181
Miscellaneous	182
Backup and restore	182
Data storage parameters	183
Parameter checksum calculation	183
User lock	184
Sine filter support	185

7. Fault tracing

What this chapter contains	187
Safety	187
Indications	187
Warnings and faults	187
Pure events	188
Editable messages	188
Warning/fault history	188
Event log	188
Viewing warning/fault information	189
QR code generation for mobile service application	189
Warning messages	190
Fault messages	204
Auxiliary codes for the LSU supply unit warnings	218
Auxiliary codes for the LSU supply unit faults	220

8. Fieldbus control through the embedded fieldbus interface (EFB)

What this chapter contains	223
System overview	223
Connecting the drive to the fieldbus	224
Setting up the embedded fieldbus interface	226
Setting the drive control parameters	227
Basics of the embedded fieldbus interface	229
Control word and Status word	230
References	230
Actual values	230
Data input/outputs	230
Register addressing	230
About the control profiles	232
Control Word	233
Control Word for the ABB Drives profile	233
Control Word for the DCU Profile	234
Status Word	237
Status Word for the ABB Drives profile	237
Status Word for the DCU Profile	238
State transition diagrams	240
State transition diagram for the ABB Drives profile	240



References	243
References for the ABB Drives profile and DCU Profile	243
Actual values	244
Actual values for the ABB Drives profile and DCU Profile	244
Modbus holding register addresses	245
Modbus holding register addresses for the ABB Drives profile and DCU Profile	245
Modbus function codes	246
Exception codes	247
Coils (0xxxx reference set)	248
Discrete inputs (1xxxx reference set)	250
Error code registers (holding registers 400090...400100)	252

9. Fieldbus control through a fieldbus adapter

What this chapter contains	253
System overview	253
Basics of the fieldbus control interface	255
Control word and Status word	255
References	256
Actual values	257
Contents of the fieldbus Control word (ABB Drives profile)	258
Contents of the fieldbus Status word (ABB Drives profile)	259
The state diagram	260
Setting up the drive for fieldbus control	261
Parameter setting example: FPBA (PROFIBUS DP) with ABB Drives profile	262
Parameter setting example: FPBA (PROFIBUS DP) with PROFIdrive profile	264
Automatic drive configuration for fieldbus control	266

10. Control chain diagrams

Contents of this chapter	267
Frequency reference selection	268
Frequency reference modification	269
Speed reference source selection II	270
Speed reference ramping and shaping	271
Speed error calculation	272
Speed feedback	273
Speed controller	274
Torque limitation	275
PID flow calculation	276
PID setpoint compensation	277
Process PID setpoint and feedback source selection	278
Process PID controller	279
External PID setpoint and feedback source selection	280
External PID controller	281
Direction lock	282

11. Parameters

What this chapter contains	284
Terms and abbreviations	285



Summary of parameter groups	286
Parameter listing	288
01 Actual values	288
03 Input references	292
04 Warnings and faults	293
05 Diagnostics	295
06 Control and status words	298
07 System info	307
10 Standard DI, RO	309
11 Standard DIO, FI, FO	319
12 Standard AI	320
13 Standard AO	325
15 I/O extension module	331
19 Operation mode	341
20 Start/stop/direction	342
21 Start/stop mode	353
22 Speed reference selection	362
23 Speed reference ramp	370
24 Speed reference conditioning	371
25 Speed control	372
28 Frequency reference chain	377
30 Limits	384
31 Fault functions	392
32 Supervision	403
34 Timed functions	410
35 Motor thermal protection	418
36 Load analyzer	430
37 User load curve	433
40 Process PID set 1	437
41 Process PID set 2	453
43 Brake chopper	456
45 Energy efficiency	457
46 Monitoring/scaling settings	462
47 Data storage	465
49 Panel port communication	466
50 Fieldbus adapter (FBA)	467
51 FBA A settings	471
52 FBA A data in	473
53 FBA A data out	473
58 Embedded fieldbus	474
60 DDCS communication	481
61 D2D and DDCS transmit data	481
62 D2D and DDCS receive data	482
71 External PID1	482
76 Multipump configuration	484
77 Multipump maintenance and monitoring	497
80 Flow calculation	499
81 Sensor settings	503
82 Pump protections	505
83 Pump cleaning	509
94 LSU control	511



<i>95 HW configuration</i>	513
<i>96 System</i>	516
<i>97 Motor control</i>	527
<i>98 User motor parameters</i>	532
<i>99 Motor data</i>	533
Differences in the default values between 50 Hz and 60 Hz supply frequency settings	540
Parameters supported by Modbus legacy compatibility	542

12. Additional parameter data

What this chapter contains	545
Terms and abbreviations	545
Fieldbus addresses	546
Parameter groups 1...9	547
Parameter groups 10...99	551

Further information

Product and service inquiries	585
Product training	585
Providing feedback on ABB Drives manuals	585
Document library on the Internet	585



1

Introduction to the manual

Contents of this chapter

The chapter describes applicability, target audience and purpose of this manual. It also describes the contents of this manual and refers to a list of related manuals for more information.

Applicability

The manual applies to the ACQ580 pump control program (version 2.12 and later).

To check the firmware version of the control program in use, see system information (select **Menu > System info > Drive**) or parameter [07.05 Firmware version](#) on the control panel.

For ACQ580-31 and ACQ580-34, to check the ISU firmware version in use, select **Menu > Options > Select drive > QCON-21** and then select **Menu > System info > Drive**, or see parameters [07.106 LSU loading package name](#) and [07.107 LSU loading package version](#) on the control panel.

Safety instructions

Follow all safety instructions.

- Read the **complete safety instructions** in the *Hardware manual* of the drive before you install, commission, or use the drive.
 - Read the **firmware function-specific warnings and notes** before changing parameter values. These warnings and notes are included in the parameter descriptions presented in chapter [Parameters](#) on page [187](#).
-

1 Target audience

The reader is expected to know the fundamentals of electricity, wiring, electrical components and electrical schematic symbols.

The manual is written for readers worldwide. Both SI and imperial units are shown. Special US instructions for installations in the United States are given.

Purpose of the manual

This manual provides information needed for designing, commissioning, or operating the drive system.

Contents of this manual

This manual consists of the following chapters:

- [Introduction to the manual](#) (this chapter) describes applicability, target audience, purpose and contents of this manual. At the end, it lists terms and abbreviations.
 - [Start-up, control with I/O and ID run](#) (page 21) describes how to start up the drive as well as how to start, change the direction of the motor rotation and adjust the motor speed through the I/O interface.
 - [Control panel](#) (page 35) contains instructions for removing and reinstalling the assistant control panel and briefly describes its display, keys, key shortcuts and home view displays.
 - [Settings, I/O and diagnostics on the control panel](#) (page 45) describes the simplified settings and diagnostic functions provided on the assistant control panel.
 - [Default I/O configuration](#) (page 83) contains the connection diagram of the Water default configuration together with a connection diagram. The predefined default configuration will save the user time when configuring the drive.
 - [Program features](#) (page 87) describes program features with lists of related user settings, actual signals, and fault and warning messages.
 - [Fieldbus control through the embedded fieldbus interface \(EFB\)](#) (page 223) describes the communication to and from a fieldbus network using the drive embedded fieldbus interface with the Modbus RTU protocol.
 - [Fieldbus control through a fieldbus adapter](#) (page 253) describes the communication to and from a fieldbus network using an optional fieldbus adapter module.
 - [Fault tracing](#) (page 187) lists the warning and fault messages with possible causes and remedies.
 - [Control chain diagrams](#) (page 267) describes the parameter structure within the drive.
 - [Parameters](#) (page 187) describes the parameters used to program the drive.
-

- [Additional parameter data](#) (page 545) contains further information on the parameters.
- [Further information](#) (inside of the back cover, page 585) describes how to make product and service inquiries, get information on product training, provide feedback on ABB Drives manuals and find documents on the Internet.

Related documents

You can find manuals and other product documents in PDF format on the Internet. See section [Document library on the Internet](#) on the inside of the back cover. For manuals not available in the Document library, contact your local ABB representative.

Drive manuals and guides	Code (English)
<i>Drive/converter/inverter safety instructions</i>	3AXD50000037978
<i>ACQ580 pump control program firmware manual</i>	3AXD50000035867
<i>ACQ580-01 (0.75 to 250 kW, 1.0 to 350 hp) hardware manual</i>	3AXD50000044862
<i>ACQ580-04 hardware manual</i>	3AXD50000048677
<i>ACQ580-07 hardware manual</i>	3AXD50000045817
<i>ACQ580-31 hardware manual</i>	3AXD50000045935
<i>ACQ580-34 hardware manual</i>	3AXD500000420025
<i>ACQ580-01 quick installation and start-up guide for frames R1 to R5</i>	3AXD50000044864
<i>ACQ580-01 quick installation and start-up guide for frames R6 to R9</i>	3AXD50000037301
<i>ACQ580-01 US quick installation and start-up guide</i>	3AXD50000049128
<i>Quick start-up guide for ACQ580 pump control program</i>	3AXD50000048773
<i>ACQ580-31 quick installation guide</i>	3AXD50000049859
<i>ACQ580-34 quick installation guide</i>	3AXD500000424634
<i>Adaptive programming application guide</i>	3AXD50000028574
<i>ACx-AP-x assistant control panels user's manual</i>	3AUA0000085685
Option manuals and guides	
<i>CPTC-02 ATEX-certified thermistor protection module, Ex II (2) GD (+L537+Q971) user's manual</i>	3AXD50000030058
<i>CDPI-01 communication adapter module user's manual</i>	3AXD50000009929
<i>FCAN-01 CANopen adapter module user's manual</i>	3AFE68615500
<i>FDNA-01 DeviceNet™ adapter module user's manual</i>	3AFE68573360
<i>FEIP-21 Ethernet/IP adapter module user's manual</i>	3AXD50000158621
<i>FENA-01/-11/-21 Ethernet adapter module user's manual</i>	3AUA0000093568
<i>FMBT-21 Modbus/TCP adapter module user's manual</i>	3AXD50000158607
<i>FPBA-01 PROFIBUS DP adapter module user's manual</i>	3AFE68573271
<i>FPNO-21 PROFINET adapter module user's manual</i>	3AXD50000158614
<i>FSCA-01 RS-485 adapter module user's manual</i>	3AUA0000109533

<i>Flange mounting kit installation supplement</i>	3AXD50000019100
<i>Flange mounting kit quick installation guide for ACX580-01 frames R1 to R3</i>	3AXD50000119172
<i>Flange mounting kit quick installation guide for ACS580-01, ACH580-01 and ACQ580-01 frames R4 to R5</i>	3AXD50000287093
<i>Flange mounting kit quick installation guide for ACS880-01 and ACX580-01 frames R6 to R9</i>	3AXD50000019099
<i>Flange mounting kit quick installation guide for ACS880-11, ACS880-31, ACH580-31 and ACQ580-31 frame R3</i>	3AXD50000181506
<i>Flange mounting kit quick installation guide for ACS880-11, ACS880-31, ACH580-31 and ACQ580-31 frames R6 and R8</i>	3AXD50000133611
<i>ACS580, ACH580 and ACQ580 drive module frames R3, R5 to R9 for cabinet installation (options +P940 and +P944 supplement)</i>	3AXD50000210305
<i>Main switch and EMC C1 filter options (+F278, +F316, +E223) installation supplement for ACS580-01, ACH580-01 and ACQ580-01 IP55 frames R1 to R5</i>	3AXD50000155132
<i>Common mode filter kit for frames R7 and R8 (option +E208) installation guide</i>	3XD50000015179
<i>UK gland plate (+H358) installation guide for ACS880-11, ACS880-31, ACH580-31 and ACQ580-31</i>	3AXD50000110711
<i>UL Type 12 hood quick installation guide for ACS580-01, ACH580-01 and ACQ580-01 frames R1 to R9</i>	3AXD50000196067

Tool and maintenance manuals and guides

<i>Drive composer PC tool user's manual</i>	3AUA0000094606
<i>Converter module capacitor reforming instructions</i>	3BFE64059629
<i>NETA-21 remote monitoring tool user's manual</i>	3AUA0000096939
<i>NETA-21 remote monitoring tool installation and start-up guide</i>	3AUA0000096881

The codes below open online listings of the manuals applicable to the products.



[ACQ580-01 manuals](#)



[ACQ580-04 manuals](#)



[ACQ580-07 manuals](#)



[ACQ580-31 manuals](#)



[ACQ580-34 manuals](#)

Categorization by frame (size)

The ACQ580 is manufactured in several frames (frame sizes), which are denoted as RN, where N is an integer. Some information which only concern certain frames are marked with the symbol of the frame (RN).

The frame is marked on the type designation label attached to the drive, see chapter *Operation principle and hardware description*, section *Type designation label* in the *Hardware manual* of the drive.

1 Terms and abbreviations

Term/abbreviation	Explanation
ACx-AP-x	Assistant control panel, advanced operator keypad for communication with the drive. The default assistant control panel for the ACQ580 is ACH-AP-H (Hand-Off-Auto control panel).
AI	Analog input; interface for analog input signals
AO	Analog output; interface for analog output signals
Brake chopper	Conducts the surplus energy from the intermediate circuit of the drive to the brake resistor when necessary. The chopper operates when the DC link voltage exceeds a certain maximum limit. The voltage rise is typically caused by deceleration (braking) of a high inertia motor.
Brake resistor	Dissipates the drive surplus braking energy conducted by the brake chopper to heat. Essential part of the brake circuit. See chapter <i>Brake chopper</i> in the <i>Hardware manual</i> of the drive.
Control board	Circuit board in which the control program runs.
CCA-01	Cold configuration adapter
CDPI-01	Communication adapter module
CHDI-01	Optional 115/230 V digital input extension module
CMOD-01	Optional multifunction extension module (external 24 V AC/DC and digital I/O extension)
CMOD-02	Optional multifunction extension module (external 24 V AC/DC and isolated PTC interface)
CPTC-02	Optional multifunction extension module (external 24 V and ATEX certified PTC interface)
CRC	Cyclic redundancy check. The IPC checks the parameter group validity in terms of CRC.
DC link	DC circuit between rectifier and inverter
DC link capacitors	Energy storage which stabilizes the intermediate circuit DC voltage
DDCS	Distributed drives communication system; a protocol used in communication between ABB drive equipment, used for ACQ580-31 and ACQ580-34 drives.
DI	Digital input; interface for digital input signals
DO	Digital output; interface for digital output signals
DPMP-01	Mounting platform for ACx-AP control panel (flange mounting)
DPMP-02/03	Mounting platform for ACx-AP control panel (surface mounting)
Drive	Frequency converter for controlling AC motors
EFB	Embedded fieldbus
FBA	Fieldbus adapter
FCAN-01	Optional CANopen adapter module
FDNA-01	Optional DeviceNet adapter module
FEIP-21	Optional Ethernet/IP adapter module

Term/abbreviation	Explanation
FENA-21	Optional Ethernet adapter module for EtherNet/IP, Modbus TCP and PROFINET IO protocols
FMBA-01	Optional Modbus RTU adapter module
FMBT-21	Optional Modbus/TCP adapter module
FPBA-01	Optional PROFIBUS DP adapter module
FPNO-21	Optional PROFINET adapter module
Frame (size)	Refers to drive physical size, for example, R1 and R2. The type designation label attached to the drive shows the frame of the drive, see chapter <i>Operation principle and hardware description</i> , section <i>Type designation label</i> in the <i>Hardware manual</i> of the drive.
FSCA-01	Optional RSA-485 adapter module
ID run	Motor identification run. During the identification run, the drive will identify the characteristics of the motor for optimum motor control.
IGBT	Insulated gate bipolar transistor
Intermediate circuit	See DC link .
Inverter	Converts direct current and voltage to alternating current and voltage.
I/O	Input/Output
IPC	Intelligent pump control
LSW	Least significant word
NETA-21	Remote monitoring tool
Network control	With fieldbus protocols based on the Common Industrial Protocol (CIP™), such as DeviceNet and Ethernet/IP, denotes the control of the drive using the Net Ctrl and Net Ref objects of the ODVA AC/DC Drive Profile. For more information, see www.odva.org , and the following manuals: <ul style="list-style-type: none"> • <i>FDNA-01 DeviceNet adapter module user's manual</i> (3AFE68573360 [English]), and • <i>FENA-01/-11/-21 Ethernet adapter module user's manual</i> (3AUA0000093568 [English]) • <i>FEIP-21 Ethernet/IP adapter module user's manual</i> (3AXD50000158621 [English]).
Parameter	User-adjustable operation instruction to the drive, or signal measured or calculated by the drive
PFC	Single pump control. One drive controls multiple pumps with motors.
PID/Loop controller	Proportional-integral-derivative controller, also known as closed loop controller. Drive speed control is based on PID algorithm.
PLC	Programmable logic controller
PROFIBUS, PROFIBUS DP, PROFINET IO	Registered trademarks of PI - PROFIBUS & PROFINET International
PTC	Positive temperature coefficient, thermistor whose resistance is dependent on temperature.

Term/abbreviation	Explanation
R1, R2 ... R11	<i>Frame (size)</i>
RO	Relay output; interface for a digital output signal. Implemented with a relay.
Rectifier	Converts alternating current and voltage to direct current and voltage.
SPFC	Soft pump control. One drive controls multiple pumps with motors.
STO	Safe torque off. See chapter <i>The Safe torque off function</i> in the <i>Hardware manual</i> of the drive.

Cybersecurity disclaimer

This product is designed to be connected to and to communicate information and data via a network interface. It is Customer's sole responsibility to provide and continuously ensure a secure connection between the product and Customer network or any other network (as the case may be). Customer shall establish and maintain any appropriate measures (such as but not limited to the installation of firewalls, application of authentication measures, encryption of data, installation of anti-virus programs, etc) to protect the product, the network, its system and the interface against any kind of security breaches, unauthorized access, interference, intrusion, leakage and/or theft of data or information. ABB and its affiliates are not liable for damages and/or losses related to such security breaches, any unauthorized access, interference, intrusion, leakage and/or theft of data or information.

2

Start-up, control with I/O and ID run

Contents of this chapter

The chapter describes how to:











- perform the start-up
- start, stop, change the direction of the motor rotation and adjust the speed of the motor through the I/O interface
- perform an Identification run (ID run) for the drive.













How to start up the drive







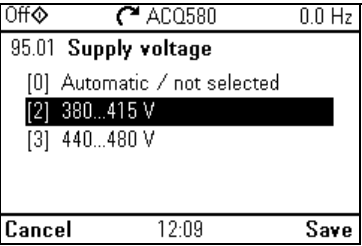







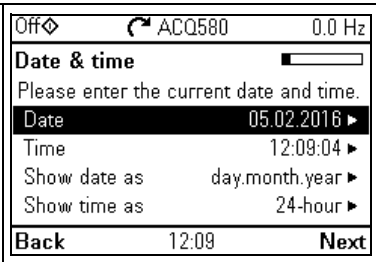

Note: Automatic selection of supply voltage is not supported in ACQ580-31 and ACQ580-34. You must select the supply voltage manually using parameter [95.01 Supply voltage](#). Follow the instructions below.

2

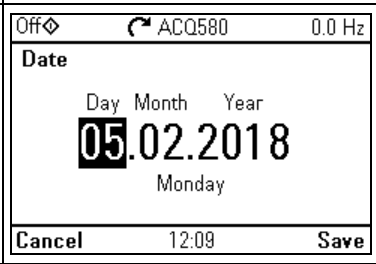
■ How to start up the drive using the First start assistant on the Hand-Off-Auto control panel

Safety	
<p> Do not start-up the drive unless you are a qualified electrician.</p> <p> Read and obey the instructions in chapter <i>Safety instructions</i> at the beginning of the <i>Hardware manual</i> of the drive. Ignoring the instructions can cause physical injury or death, or damage to the equipment.</p>	
<input type="checkbox"/>	Check the installation. See chapter <i>Installation checklist</i> in the <i>Hardware manual</i> of the drive.
<input type="checkbox"/>	<p> Make sure there is no active start on (DI1 in factory settings, that is, Water default configuration). The drive will start up automatically at power-up if the external run command is on and the drive is in the external control mode.</p> <p>Check that the starting of the motor does not cause any danger.</p> <p>De-couple the driven machine if</p> <ul style="list-style-type: none"> • there is a risk of damage in case of an incorrect direction of rotation, or • a Normal ID run is required during the drive start-up, when the load torque is higher than 20% or the machinery is not able to withstand the nominal torque transient during the ID run.
Hints on using the assistant control panel	
<p>The two commands at the bottom of the display (Options and Menu in the figure on the right), show the functions of the two softkeys  and  located below the display. The commands assigned to the softkeys vary depending on the context.</p> <p>Use keys , ,  and  to move the cursor and/or change values depending on the active view.</p> <p>Key  shows a context-sensitive help page.</p> <p>For more information, see <i>ACx-AP-x assistant control panels user's manual</i> (3AUA0000085685 [English]).</p>	
1 – First start assistant guided settings: Language, date and time, and motor nominal values	
<input type="checkbox"/>	Have the motor or pump name plate data at hand. Power up the drive.

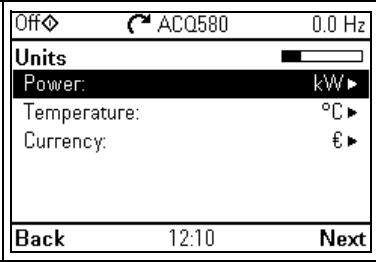
<input type="checkbox"/>	<p>The First start assistant guides you through the first start-up.</p> <p>The assistant begins automatically. Wait until the control panel enters the view shown on the right.</p> <p>Select the language you want to use by highlighting it (if not already highlighted) and pressing  (OK).</p>	
<input type="checkbox"/>	<p>ACQ580-31 and ACQ580-34 drives: Select the supply voltage with parameter 95.01 Supply voltage:</p> <ul style="list-style-type: none"> • In the First start assistant menu, select Exit and press  (Next). • In the Home view, press  (Menu) to enter the Main menu. • In the Main menu, go to Parameters > Complete list > 95 HW configuration by selecting the correct row and pressing  (Select) repeatedly. • Select parameter 95.01 Supply voltage and press  (Edit). • Select supply voltage 380...415 or 440...480 using keys  and . Press  (Save). • Go back to the Main menu by pressing  (Back) repeatedly. • In the Main menu, select First start assistant and press  (Select) to enter the First start assistant menu. • Continue with the following steps for commissioning the ACQ580. 	
<input type="checkbox"/>	<p>Select Start set-up and press  (Next).</p>	

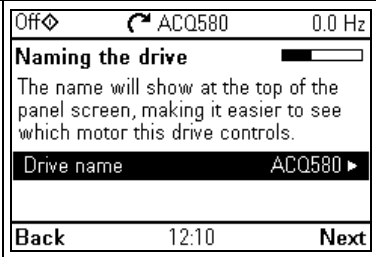
<input type="checkbox"/> Set the date and time as well as date and time display formats. <ul style="list-style-type: none"> Go to the edit view of a selected row by pressing . Scroll the view with  and . Go to the next view by pressing  (Next).	
<input type="checkbox"/> To change a value in an edit view: <ul style="list-style-type: none"> Use  and  to move the cursor left and right. Use  and  to change the value. Press  (Save) to accept the new setting, or press  (Cancel) to go back to the previous view without making changes. 	
<input type="checkbox"/> Change the units shown on the control panel if needed. <ul style="list-style-type: none"> Go to the edit view of a selected row by pressing . Scroll the view with  and . Go to the next view by pressing  (Next).	
<input type="checkbox"/> To give the drive a name that will be shown at the top, press  . If you do not want to change the default name (ACQ580), continue by pressing  (Next). Hint: Name the drive, for example, Pump 1.	

Refer to the motor or pump nameplate for the following nominal value settings of the motor. Enter the values exactly as shown on the motor or pump nameplate.

Example of a nameplate of an induction (asynchronous) motor:

ABB Motors		CE					
3 ~ motor		M2AA 200 MLA 4					
		IEC 200 M/L 55					
		No					
		Ins.cl. F					
		IP 55					
V	Hz	kW	r/min	A	cos ϕ	IA/IN	tE/s
690 Y	50	30	1475	32.5	0.83		
400 D	50	30	1475	56	0.83		
660 Y	50	30	1470	34	0.83		
380 D	50	30	1470	59	0.83		
415 D	50	30	1475	54	0.83		
440 D	60	35	1770	59	0.83		
Cat. no		3GAA 202 001 - ADA					
6312/C3		6210/C3		180 kg			
						IEC 34-1	

- Check that the motor data is correct. Values are predefined on the basis of the drive size but you should verify that they correspond to the motor. Start with the motor type. Go to the edit view of a selected row by pressing .
- Scroll the view with and .
- Motor nominal $\cos\phi$ and nominal torque are optional.
- Press (**Next**) to continue.

Off ACQ580 0.0 Hz

Motor nominal values

Find the values on the motor's nameplate, and enter them here:

Type: Asynchronous motor

Current: 1.8 A

Voltage: 400.0 V

Back 12:10 Next

- Adjust the limits according to your needs.
- Go to the edit view of a selected row by pressing .
 - Scroll the view with and .
- Go to the next view by pressing (**Next**).

Off ACQ580 0.0 Hz

Limits

Check the allowed operation range:

Minimum frequency 0.00 Hz

Maximum frequency 50.00 Hz

Back 12:10 Next

- If you want to make a backup of the settings made so far, select **Backup** and press (**Next**). If you do not want to make a backup, select **Not now** and press (**Next**).

Off ACQ580 0.0 Hz







Make backup?

Copies all settings into a backup file stored in the control panel. To restore a backup, go to Menu > Backups.

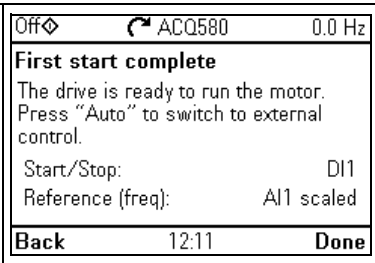



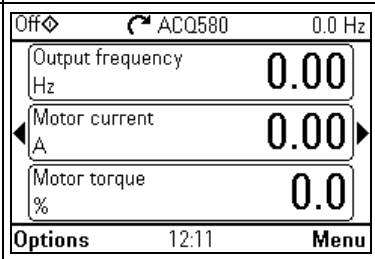







Backup

Not now

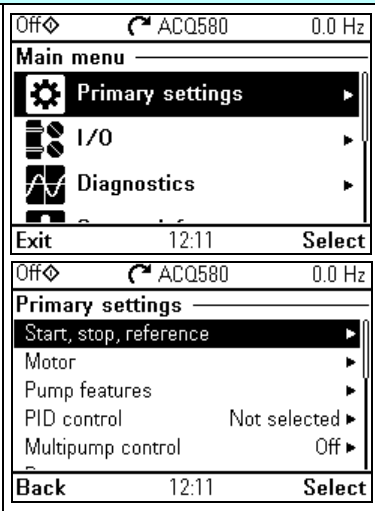
Back 12:10 Next

<p><input type="checkbox"/> The first start is now complete and the drive is ready for use. Press  (Done) to enter the Home view.</p>	 <p>Off  ACQ580 0.0 Hz</p> <p>First start complete The drive is ready to run the motor. Press "Auto" to switch to external control.</p> <p>Start/Stop: DI1 Reference (freq): All scaled</p> <p>Back 12:11 Done</p>
<p><input type="checkbox"/> The Home view 1 monitoring the values of the selected signals is shown on the control panel. There are four preconfigured Home view displays. Home view 1 is the default Home view. You can browse them with keys  and . See section Home view displays on page 40.</p>	 <p>Off  ACQ580 0.0 Hz</p> <p>Output frequency 0.00 Hz Motor current 0.00 A Motor torque 0.0 %</p> <p>Options 12:11 Menu</p>

2 – Additional settings in the Primary settings menu

<p><input type="checkbox"/> Make any additional adjustments, for example, pump protections, starting from the Main menu – press  (Menu) to enter the Main menu. Select Primary settings and press  (Select) (or ).</p> <p>In the Primary settings menu, select Pump features and press  (Select) (or ).</p> <p>To get more information on the Primary settings menu items, press  to open the help page.</p>	 <p>Off  ACQ580 0.0 Hz</p> <p>Main menu</p> <ul style="list-style-type: none">  Primary settings ▶  I/O ▶  Diagnostics ▶ <p>Exit 12:11 Select</p> <hr/> <p>Off  ACQ580 0.0 Hz</p> <p>Primary settings</p> <ul style="list-style-type: none"> Start, stop, reference ▶ Motor ▶ Pump features ▶ PID control Not selected ▶ Multipump control Off ▶ <p>Back 12:11 Select</p>
---	--

3 – Hand/Off/Auto operation

The drive can be in remote control or local control, and in local control there are additionally two different modes.

Remote control: Drive is controlled from the I/O or the fieldbus.

- Top row of the view shows Auto.

Local control: Drive is controlled from the control panel.

- Top row of the view shows Off, that is, the drive is in the Off mode. Drive is stopped.
- Top row of the view shows Hand, that is, the drive is in the Hand mode. Drive is running. The initial reference in the Hand mode is copied from the drive reference.

Symbol \blacklozenge on the top row indicates that you can change the reference with \blacktriangleup and \blacktriangledown .

The following diagram shows the state transitions when you press the Hand, Off or Auto button:

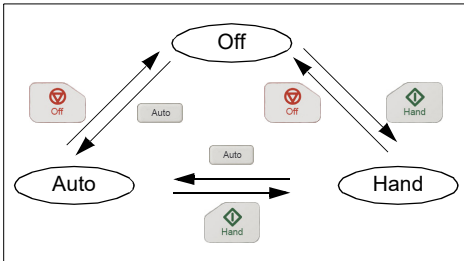

Note: If fault **7081 Control panel loss** is active and the drive is powered down, the mode changes to Auto when power is reapplied.

Auto	ACQ580	30.0 Hz
Output frequency	Hz	30.00
Motor current	A	0.46
Motor torque	%	8.9
Options	12:30	Menu
Off \blacklozenge	ACQ580	0.0 Hz
Output frequency	Hz	0.00
Motor current	A	0.00
Motor torque	%	0.0
Options	12:37	Menu
Hand \blacklozenge	ACQ580	30.0 Hz
Output frequency	Hz	30.00
Motor current	A	0.46
Motor torque	%	8.8
Reference	12:38	Menu
Off \blacklozenge	ACQ580	0.0 Hz
Fault 7081	Aux code: 0000 0000	
Control panel loss	12:41:43	
Control panel loss fault		
Hide	12:42	Reset

How to control the drive through the I/O interface

The table below describes how to operate the drive through the digital and analog inputs when:

2

- the motor start-up is performed, and
- the default parameter settings of the Water default configurations are in use.

Preliminary settings	
<p>If you need to change the direction of rotation, check that limits allow reverse direction: Check parameter group 30 Limits and make sure that the minimum limit has a negative value and the maximum limit has a positive value.</p> <p>Default settings only allow forward direction.</p> <p>Note: Efficient pump cleaning can require reverse speed.</p> <p>Make sure that the control connections are wired according to the connection diagram given for the Water default.</p> <p>Make sure that the drive is in external control. To switch to external control, press key Auto.</p>	<p>See section Water default on page 84.</p> <p>In external control, the control panel display shows text Auto at the top left.</p>
Starting and controlling the speed of the motor	
<p>Start by switching digital input DI1 on.</p> <p>The arrow starts rotating. It is dotted until the setpoint is reached.</p> <p>Regulate the drive output frequency (motor speed) by adjusting voltage of analog input AI1.</p> <p>Note: If the drive will not start, check that the start interlock 1 (parameter 20.41) is active (1). For the Water default, the start interlock 1 is connected to DI4 by default.</p>	
Stopping the motor	
<p>Switch digital input DI1 off. The arrow stops rotating.</p>	

How to perform the ID run

The drive automatically estimates motor characteristics using *Standstill* ID run when the drive is started for the first time in vector control and after any motor parameter (group [99 Motor data](#)) is changed. This is valid when

- parameter [99.13 ID run requested](#) selection is *Standstill* and
- parameter [99.04 Motor control mode](#) selection is *Vector*.

In most applications there is no need to perform a separate ID run. The ID run should be selected manually if:

- vector control mode is used (parameter [99.04 Motor control mode](#) is set to *Vector*), and
- permanent magnet motor (PM) is used (parameter [99.03 Motor type](#) is set to *Permanent magnet motor*), or
- synchronous reluctance motor (SynRM) is used (parameter [99.03 Motor type](#) is set to *SynRM*), or
- drive operates near zero speed references, or
- operation at torque range above the motor nominal torque, over a wide speed range is needed.

Do the ID run with the ID run assistant by selecting **Menu > Primary settings > Motor > ID run** (see page [30](#)).

Note: If motor parameters ([99 Motor data](#)) are changed after the ID run, it must be repeated.

Note: If you have already parameterized your application using the scalar motor control mode ([99.04 Motor control mode](#) is set to *Scalar*) and you need to change motor control mode to *Vector*,







- change the control mode to vector with the **Control mode** assistant (go to **Menu > Primary settings > Motor > Control mode**) and follow the instructions. The ID run assistant then guides you through the ID run.







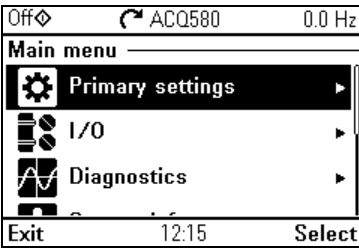

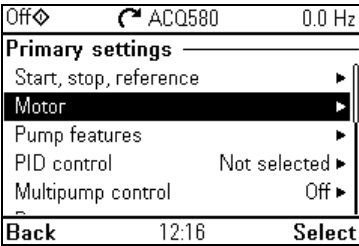



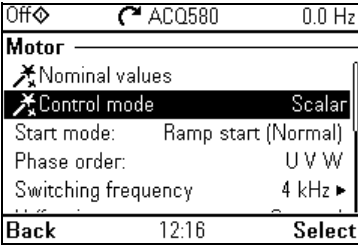

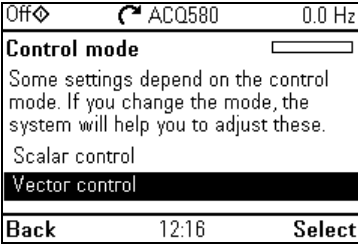

or

- set parameter [99.04 Motor control mode](#) to *Vector*, and
 - for I/O controlled drive, check parameters in groups [22 Speed reference selection](#), [23 Speed reference ramp](#), [12 Standard AI](#), [30 Limits](#) and [46 Monitoring/scaling settings](#).

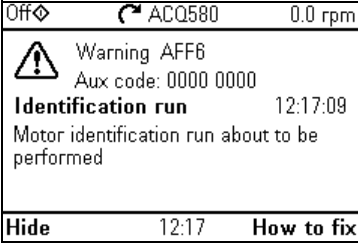
■ ID run procedure with the ID Run assistant

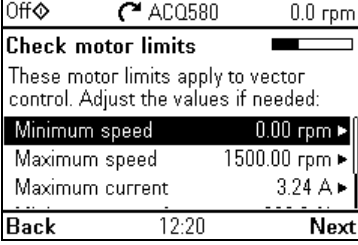
2

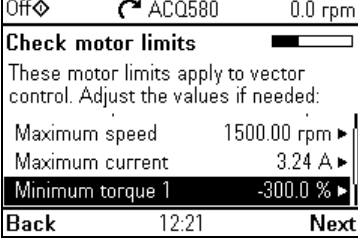
Pre-check	
<p> WARNING! The motor will run at up to approximately 50...80% of the nominal speed during the ID run. The motor will rotate in the forward direction. Make sure that it is safe to run the motor before performing the ID run!</p>	
<p><input type="checkbox"/> De-couple the motor from the pump.</p> <p><input type="checkbox"/> Check that the values of the motor data parameters are equivalent to those on the motor nameplate.</p> <p><input type="checkbox"/> Check that the STO circuit is closed.</p> <p>If parameter values (from group <i>10 Standard DI, RO</i> to group <i>99 Motor data</i>) are changed before the ID run, check that the new settings meet the following conditions:</p> <p><input type="checkbox"/> <i>30.11 Minimum speed</i> ≤ 0 rpm</p> <p><input type="checkbox"/> <i>30.12 Maximum speed</i> = motor rated speed (Normal ID run procedure needs the motor to be run at 100% speed.)</p> <p><input type="checkbox"/> <i>30.17 Maximum current</i> > I_{HD}</p> <p><input type="checkbox"/> <i>30.20 Maximum torque 1</i> > 50%.</p> <p>Check that the run permissive signal (parameter <i>20.40 Run permissive</i>) is active</p> <p><input type="checkbox"/> Make sure that the control panel is in the Off mode control (text Off shown at the top left). Press the Off key  to switch to the Off mode.</p>	
ID run	
<p><input type="checkbox"/> Go to the Main menu by pressing  (Menu) in the Home view.</p> <p>Select Primary settings and press  (Select) (or ).</p>	 <p>The screenshot shows the 'Main menu' with 'Primary settings' highlighted. Other options include 'I/O' and 'Diagnostics'. At the bottom, there is an 'Exit' button with a timer '12:15' and a 'Select' button.</p>
<p><input type="checkbox"/> Select Motor and press  (Select) (or ).</p>	 <p>The screenshot shows the 'Primary settings' menu with 'Motor' highlighted. Other options include 'Start, stop, reference', 'Pump features', 'PID control' (Not selected), and 'Multipump control' (Off). At the bottom, there is a 'Back' button with a timer '12:16' and a 'Select' button.</p>

<input type="checkbox"/>	<p>If the control modes is scalar, select Control mode and press  (Select) (or ) and continue to the next step.</p>	 <p>Off  ACQ580 0.0 Hz</p> <p>Motor</p> <p> Nominal values</p> <p> Control mode Scalar</p> <p>Start mode: Ramp start (Normal)</p> <p>Phase order: U V W</p> <p>Switching frequency 4 kHz ▶</p> <p>Back 12:16 Select</p>
<input type="checkbox"/>	<p>Select Vector control and press  (Select) (or )</p>	 <p>Off  ACQ580 0.0 Hz</p> <p>Control mode</p> <p>Some settings depend on the control mode. If you change the mode, the system will help you to adjust these.</p> <p>Scalar control</p> <p>Vector control</p> <p>Back 12:16 Select</p>
<input type="checkbox"/>	<p>Warning message Identification run is shown for a moment.</p>	 <p>Off  ACQ580 0.0 rpm</p> <p> Warning AFB6 Aux code: 0000 0000</p> <p>Identification run 12:17:09</p> <p>Motor identification run about to be performed</p> <p>Hide 12:17 How to fix</p>
<input type="checkbox"/>	<p>Check the motor speed limits. The following must be true:</p> <ul style="list-style-type: none"> • Minimum speed ≤ 0 rpm • Maximum speed = motor rated speed. 	 <p>Off  ACQ580 0.0 rpm</p> <p>Check motor limits</p> <p>These motor limits apply to vector control. Adjust the values if needed:</p> <p>Minimum speed 0.00 rpm ▶</p> <p>Maximum speed 1500.00 rpm ▶</p> <p>Maximum current 3.24 A ▶</p> <p>Back 12:20 Next</p>
<input type="checkbox"/>	<p>Check the motor current as well as torque limits. The following must be true:</p> <ul style="list-style-type: none"> • Maximum current $> I_{HD}$ • Maximum torque $> 50\%$. 	 <p>Off  ACQ580 0.0 rpm</p> <p>Check motor limits</p> <p>These motor limits apply to vector control. Adjust the values if needed:</p> <p>Maximum speed 1500.00 rpm ▶</p> <p>Maximum current 3.24 A ▶</p> <p>Minimum torque 1 -300.0 % ▶</p> <p>Back 12:21 Next</p>

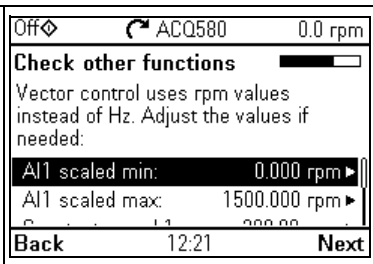
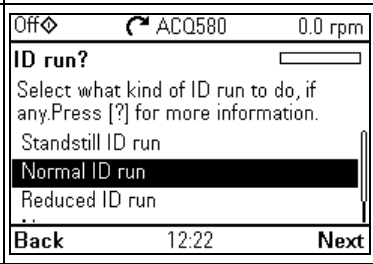
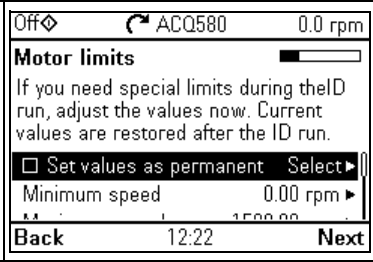
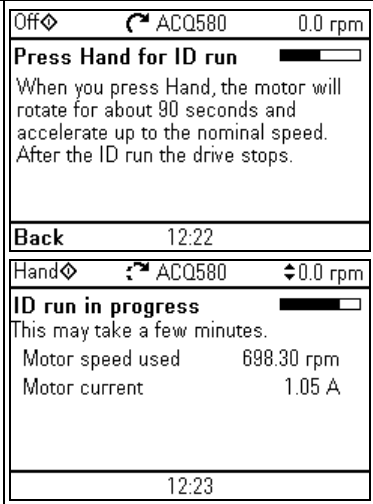
<input type="checkbox"/> Check that AI is scaled correctly for the control mode in use. In speed control mode, check that AI1 scaled max = 1500 or 1800 rpm. In scalar control mode, check AI1 scaled max = 50 or 60 Hz.	
<input type="checkbox"/> Select the type of ID run (see parameter 99.13 ID run requested) to be performed and press (Select) (or (▶)).	
<input type="checkbox"/> Check the motor limits shown on the control panel. If you need other limits during the ID run you can enter them here. The originals limits will be restored after the ID run, unless you select Set values as permanent .	
<input type="checkbox"/> Press the Hand key ((◀▶)) to start the ID run. In general, it is recommended not to press any control panel keys during the ID run. However, you can stop the ID run at any time by pressing the Off key ((⏻)). During the ID run a progress view is shown. After the ID run is completed, text ID run done is shown. The LED stops blinking. If the ID run fails, fault FF61 ID run is shown. See chapter Fault tracing on page 187 for more information.	

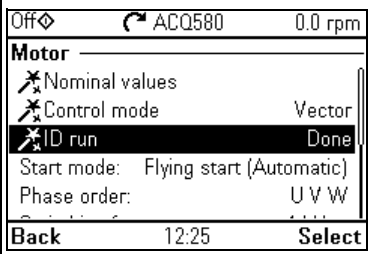
<input type="checkbox"/>	After the ID run is completed, text Done is shown on row ID run .	 <p>The screenshot shows a motor control interface. At the top, it displays 'Off' with a diamond symbol, 'ACQ580', and '0.0 rpm'. Below this is a 'Motor' section with a scrollable list of options: 'Nominal values', 'Control mode' (set to 'Vector'), 'ID run' (set to 'Done'), 'Start mode: Flying start (Automatic)', and 'Phase order: U V W'. At the bottom, there are 'Back' and 'Select' buttons, with the time '12:25' displayed between them.</p>
--------------------------	---	--

3

3

Control panel

Contents of this chapter

This chapter contains instructions for removing and reinstalling the assistant control panel ACH-AP-H or ACH-AP-W and briefly describes its display, keys and key shortcuts. For more information, see *ACx-AP-x assistant control panels user's manual* (3AUA0000085685 [English]).

Removing and reinstalling the control panel

To remove the control panel, press the retaining clip at the top (1a) and pull it forward from the top edge (1b).

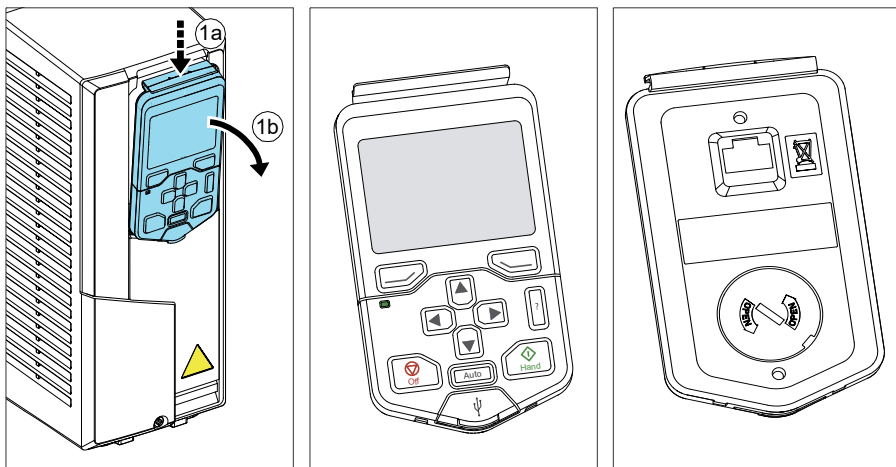

To reinstall the control panel, put the bottom of the container in position (1a), press the retaining clip at the top (1b) and push the control panel in at the top edge (1c).

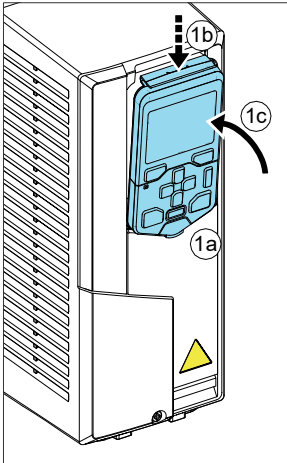

Layout of the control panel

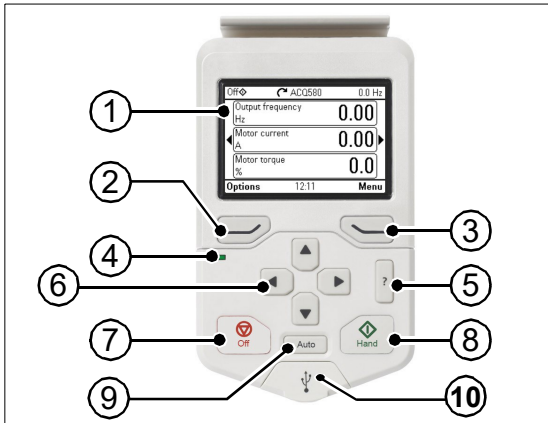

1	Layout of the control panel display
2	Left softkey
3	Right softkey
4	Status LED, see chapter <i>Maintenance and hardware diagnostics</i> , section <i>LEDs in the Hardware manual of the drive</i> .
5	Help

6	The arrow keys
7	Off (see Hand , Off and Auto)
8	Hand (see Hand , Off and Auto)
9	Auto (see Hand , Off and Auto)
10	USB connector

Layout of the control panel display

In most views, the following elements are shown on the display:

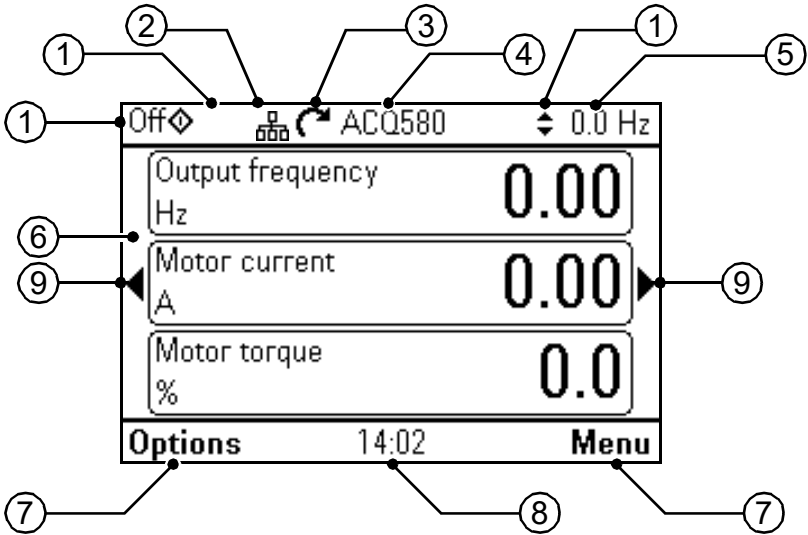





1. **Control location and related icons:** Indicates how the drive is controlled:

- **No text:** The drive is in local control, but controlled from another device. The icons in the top pane indicate which actions are allowed:

Text/icons	Starting from this control panel	Stopping from this control panel	Giving reference from this control panel
	Not allowed	Not allowed	Not allowed

- **Local:** The drive is in local control, and controlled from this control panel. The icons in the top pane indicate which actions are allowed:









Text/icons	Starting from this control panel	Stopping from this control panel	Giving reference from this control panel
Off  	Allowed	Drive is stopped	Not allowed
Hand  	Allowed	Allowed	Allowed



- **External:** The drive is in external control, ie, controlled through I/O or fieldbus. The icons in the top pane indicate which actions are allowed with the control panel:

Text/Icons	Starting from this control panel	Stopping from this control panel	Giving reference from this control panel
Auto	Allowed ¹⁾	Allowed ¹⁾	Not allowed
Auto 	Not allowed	Allowed	Allowed

¹⁾ This action can be Not allowed by changing parameters [19.18 HAND/OFF disable source](#) and [19.19 HAND/OFF disable action](#).

2. **Panel bus:** Indicates that there are more than one drive connected to this panel. To switch to another drive, go to **Options > Select drive**.
3. **Status icon:** Indicates the status of the drive and the motor. The direction of the arrow indicates forward (clockwise) or reverse (counter-clockwise) rotation.

Status icon	Animation	Drive status
	-	Stopped
	-	Stopped, start inhibited
	Blinking	Stopped, start command given but start inhibited. See Menu > Diagnostics on the control panel
	Blinking	Faulted
	Blinking	Running, at reference, but the reference value is 0
	Rotating	Running, not at reference
	Rotating	Running, at reference
	-	Pre-heating (motor heating) active
	-	PID sleep mode active

4. **Drive name:** If a name has been given, it is displayed in the top pane. By default, it is "ACQ580". You can change the name on the control panel by selecting **Menu > Primary settings > Clock, region, display** (see page [70](#)).
5. **Reference value:** Speed, frequency, etc. is shown with its unit. For information on changing the reference value in the **Primary settings** menu (see page [53](#)).
6. **Content area:** The actual content of the view is displayed in this area. The content varies from view to view. The example view on page [37](#) is the main view of the control panel which is called the Home view.
7. **Softkey selections:** Displays the functions of the softkeys ( and ) in a given context.

8. **Clock:** The clock displays the current time. You can change the time and time format on the control panel by selecting **Menu > Primary settings > Clock, region, display** (see page 70).
9. **Side arrows:** When side arrows are visible, you can browse other Home views with the arrow keys (◀) and (▶).

You can adjust the display contrast and back light functionality on the control panel by selecting **Menu > Primary settings > Clock, region, display** (see page 70).

Home view displays

There are four different preconfigured basic Home view displays. In addition, there are six preconfigured IPC Home views and seven preconfigured Level control Home views (see section [IPC and Level control additional Home view displays](#) on page 41).

Home view 1 is the default Home view. You can browse them with the arrow keys (◀ and ▶). To edit Home views, press the Option softkey (⏏), see section [Options menu](#) on page 81.

3

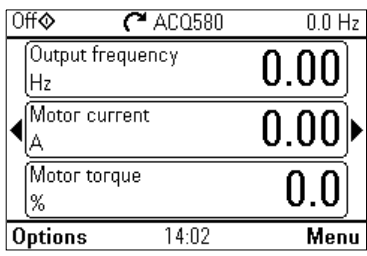
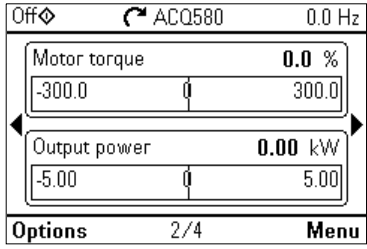
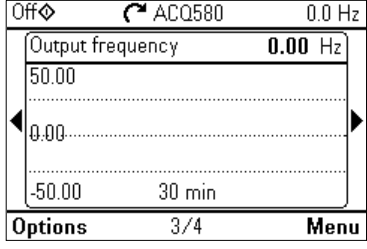
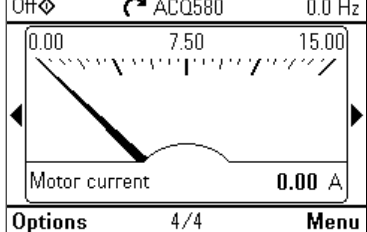
<p>Home view 1 (default Home view):</p> <ul style="list-style-type: none"> • Output frequency (Hz): Parameter 01.06 Output frequency • Motor current (A): Parameter 01.07 Motor current • Motor torque (%): Parameter 01.10 Motor torque 	
<p>Home view 2:</p> <ul style="list-style-type: none"> • Motor torque (%): Parameter 01.10 Motor torque • Parameter 01.14 Output power 	
<p>Home view 3:</p> <ul style="list-style-type: none"> • Output frequency shown as a graphical representation during the last 30 minutes: Parameter 01.06 Output frequency 	
<p>Home view 4:</p> <ul style="list-style-type: none"> • Motor current shown as a dial gauge: Parameter 01.07 Motor current 	

■ IPC and Level control additional Home view displays

There are six preconfigured IPC Home views and seven preconfigured Level control Home views, of which the first six are the same as IPC home views. You can browse them with the arrow keys (◀) and (▶). To edit Home views, press the Option softkey (☰), see section [Options menu](#) on page 81.

<p>IPC / Level control Home view 1 (default IPC / level control Home view):</p> <ul style="list-style-type: none"> • Output frequency (Hz): Parameter 01.06 Output frequency • Process feedback (bar): Parameter 40.02 Process PID feedback actual • Multipump system status: Parameter 76.02 Multipump system status 	
<p>IPC / level control Home view 2:</p> <ul style="list-style-type: none"> • Multipump node number: Parameter 76.22 Multipump node number • IPC synchronization checksum: Parameter 76.105 IPC synchronization checksum • IPC online pumps: Parameter 76.01 PFC status 	
<p>IPC / level control Home view 3:</p> <ul style="list-style-type: none"> • Pump 1 running time: Parameter 77.11 Pump 1 running time • Pump 2 running time: Parameter 77.12 Pump 2 running time • Pump 3 running time: Parameter 77.13 Pump 3 running time 	
<p>IPC / level control Home view 4:</p> <ul style="list-style-type: none"> • Pump 4 running time: Parameter 77.14 Pump 4 running time • Pump 5 running time: Parameter 77.15 Pump 5 running time • Pump 6 running time: Parameter 77.16 Pump 6 running time 	

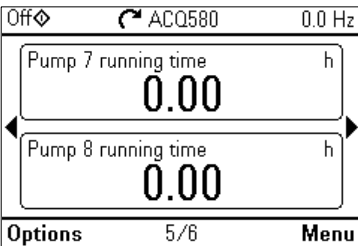
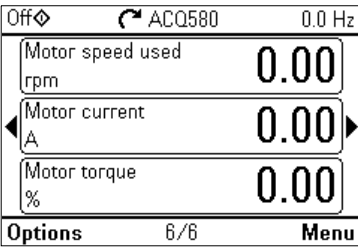
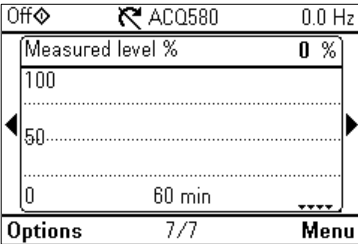
<p>IPC / level control Home view 5:</p> <ul style="list-style-type: none"> • Pump 7 running time: Parameter 77.17 Pump 7 running time • Pump 8 running time: Parameter 77.18 Pump 8 running time 	
<p>IPC / level control Home view 6:</p> <ul style="list-style-type: none"> • Output frequency (Hz): Parameter 01.06 Output frequency • Motor current (A): Parameter 01.07 Motor current • Motor torque (%): Parameter 01.10 Motor torque 	
<p>Level control Home view 7:</p> <ul style="list-style-type: none"> • Measured level (%) shown as a graphical representation during the last 60 minute: Parameter 76.06 Measured level % 	

Keys

The keys of the control panel are described below.



Left softkey



The left softkey () is usually used for exiting and canceling. Its function in a given situation is shown by the softkey selection in the bottom left corner of the display.







Holding  down exits each view in turn until you are back in the Home view. This function does not work in special screens.

Right softkey

The right softkey () is usually used for selecting, accepting and confirming. The function of the right softkey in a given situation is shown by the softkey selection in the bottom right corner of the display.

The arrow keys

The up and down arrow keys ( and ) are used to highlight selections in menus and selection lists, to scroll up and down on text pages, and to adjust values when, for example, setting the time, entering a passcode or changing a parameter value.

The left and right arrow keys ( and ) are used to move the cursor left and right in parameter editing and to move forward and backward in assistants. In menus,  and  function the same way as  and , respectively.

Help

The help key () opens a help page. The help page is context-sensitive, in other words, the content of the page is relevant to the menu or view in question.

Hand, Off and Auto

The ACQ580 can be in local or external control. The local control has two modes: Hand and Off. See also the diagram in section [Local control vs. external control](#) on page 87.

Hand key ():

- In local control / Off mode: Starts the drive. The drive will switch to the Hand mode.
- In external control: Switches the drive to local control / Hand mode, keeping it running.

Off key ():



- Stops the drive and switches to the Off mode.















Auto key ():

- In local control: The drive will switch to external control.

Key shortcuts

The table below lists key shortcuts and combinations. Simultaneous key presses are indicated by the plus sign (+).

Shortcut	Available in	Effect
 +  + 	any view	Save a screenshot. Up to fifteen images may be stored in the control panel memory. To transfer images to PC, connect the assistant control panel to PC with a USB cable and the panel will mount itself as an MTP (media transfer protocol) device. Pictures are stored in the screen shots folder. For more instructions, see <i>ACX-AP-x assistant control panels user's manual</i> (3AUA0000085685 [English]).

Shortcut	Available in	Effect
 +  ,  + 	any view	Adjust backlight brightness.
 +  ,  + 	any view	Adjust display contrast.
 or 	Home view	Adjust reference.
 + 	parameter edit views	Revert an editable parameter to its default value.
 + 	view showing a list of selections for a parameter	Show/hide selection index numbers.
 (keep down)	any view	Return to the Home view by pressing down the key until the Home view is shown.

4

Settings, I/O and diagnostics on the control panel

4

Contents of this chapter

This chapter provides detailed information about the **Primary settings**, **I/O**, **Diagnostics**, **System info**, **Energy efficiency** and **Backups** menus using the control panel.

To get to these menus from the Home view, first select **Menu** to go the **Main** menu, and in the **Main** menu, select the menu you want.

Off	ACQ580	0.0 Hz
Output frequency		0.00
Hz		
Motor current		0.00
A		
Motor torque		0.0
%		
Options	14:23	Menu

Off	ACQ580	0.0 Hz
Main menu		
	Primary settings	▶
	I/O	▶
	Diagnostics	▶
Exit	14:31	Select

Primary settings

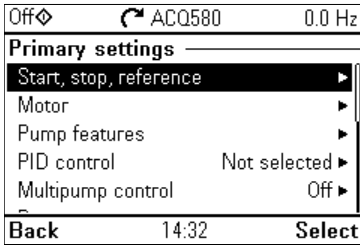

4

To go the **Primary settings** menu from the Home view, select **Menu > Primary settings**.

After using the guided settings with the first start assistant, you may want to select another default configuration by selecting **Start, stop, reference > Basic operations set-up** and **Start, stop, reference > Basic control set-up** and following the set-up assistants to configure process and control settings.

- The **Primary settings** menu enables you to adjust and define additional settings used in the drive.

With the **Primary settings** menu, you can also adjust settings related to the motor, pump functionalities, fieldbus communication, PID, fault functions, advanced functions and clock, region and display. In addition, you can reset the fault and event logs, control panel Home view, parameters not related to hardware, fieldbus settings, motor data and ID run results, all parameters, end user texts as well as reset everything to factory defaults.

Note that the **Primary settings** menu enables you to program the majority of the drive functionality or features: more advanced configuration is done via the parameters: Select **Menu > Parameters**. For more information on the different parameters, see chapter [Parameters](#) on page 283.

In the **Setting** menu, the  symbol indicates multiple connected signals/parameters.

The  symbol indicates that the setting provides an assistant when modifying the parameters. When using an assistant make sure that all the set values are saved by completing the assistant.

To get more information on **Primary settings** menu items, press the  key to open the help page.

The sections below provide detailed information about the contents of the different submenus available in the **Primary settings** menu.

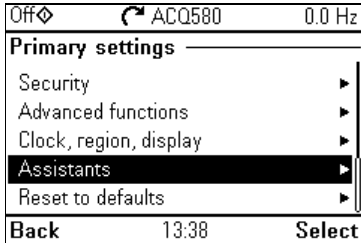

■ Assistants



4

The **Assistants** submenu includes a variety of assistants that can be used to configure the drive.

The table below provides detailed information about the available setting items in the **Assistants** submenu.

Menu item	Description	Corresponding parameter
 First start assistant	Runs the same First start assistant that is used to commission the drive.	
 Basic operation setup	<u>Equipment type?</u> Blower <ul style="list-style-type: none"> • Ramps • Control setup Pump <ul style="list-style-type: none"> • Submersible/turbine • Quick ramp stage 1 • Quick ramp stage 2 • Normal ramp stage 3 • Control setup Other <ul style="list-style-type: none"> • Ramps • Control setup 	

Menu item	Description	Corresponding parameter
✘ Basic control setup	<p><u>How do you control?</u></p> <p><u>SCADA</u></p> <ul style="list-style-type: none"> • Reference (AI1) scaling • Relay outputs • “Start interlock signal” • “Run permissive signal” <p><u>Direct control via I/O (Water default configuration)</u></p> <ul style="list-style-type: none"> • Reference (AI1) scaling • Relay outputs • “Start interlock signal” • “Run permissive signal” <p><u>Direct control via fieldbus comm.</u></p> <ul style="list-style-type: none"> • Communication settings <p><u>PID control, single motor</u></p> <ul style="list-style-type: none"> • Feedback (AI2) scaling • Setpoint source • Constant setpoint 	
✘ Nominal values	<p>Enter the motor’s nominal values from the motor’s nameplate.</p> <p>Selects whether to use scalar or vector control mode.</p> <p>For information on scalar control mode, see section Scalar motor control on page 145.</p> <p>For information on vector control mode, see section Vector motor control on page 146</p>	<p>99.03 Motor type ...</p> <p>99.12 Motor nominal torque</p>
✘ ID run	<p>Perform the Identification run described in section How to perform the ID run (page 29).</p>	<p>99.13 ID run requested</p>
✘ PID assistant	<p>Configures secondary control location to use PID control.</p> <p><u>Feedback:</u> AI2. Adjust the scaling of AI2 signal for feedback, if required.</p> <p><u>Setpoint:</u> Select a constant value, control panel or AI1. If you selected AI2, adjust the scaling of AI1 signal for setpoint.</p> <p><u>Start/stop:</u> DI</p>	
Security	<p>See section Security (page 67).</p>	
✘ Control mode	<p>Selects whether to use scalar or vector control mode.</p> <p>For information on scalar control mode, see section Scalar motor control on page 145.</p> <p>For information on vector control mode, see section Vector motor control on page 146.</p>	<p>99.04 Motor control mode</p>

Menu item	Description	Corresponding parameter
✖ Synchronization settings	Runs the Synchronization settings assistant.	96.20 Time sync primary source
✖ Set HQ curve points	Runs the assistant for HQ performance curve for flow calculation. Note: This menu item is only visible if the parameter 80.13 value has been set to <i>HQ curve</i> .	80.13 Flow feedback function
✖ Set PQ curve points	Runs the assistant for PQ performance curve for flow calculation. Note: This menu item is only visible if the parameter 80.13 value has been set to <i>PQ curve</i> .	80.13 Flow feedback function

Start, stop, reference

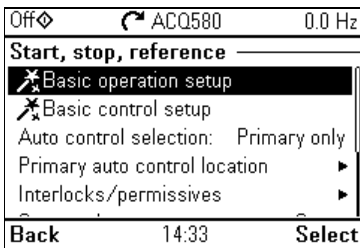

Use the **Start, stop, reference** submenu to set up start/stop commands, reference, and related features, such as constant speeds or run permissions.

The table below provides detailed information about the available setting items in the **Start, stop, reference** submenu.

Menu item	Description	Corresponding parameter
✖ Basic operation setup	<u>Equipment type?</u> Blower <ul style="list-style-type: none"> • Ramps • Control setup Pump <ul style="list-style-type: none"> • Submersible/turbine • Quick ramp stage 1 • Quick ramp stage 2 • Normal ramp stage 3 • Control setup Other <ul style="list-style-type: none"> • Ramps • Control setup 	

Menu item	Description	Corresponding parameter
Basic control setup	<p><u>How do you control?</u></p> <p><u>SCADA</u></p> <ul style="list-style-type: none"> • Reference (AI1) scaling • Relay outputs • “Start interlock signal” • “Run permissive signal” <p><u>Direct control via I/O (Water default configuration)</u></p> <ul style="list-style-type: none"> • Reference (AI1) scaling • Relay outputs • “Start interlock signal” • “Run permissive signal” <p><u>Direct control via fieldbus comm.</u></p> <ul style="list-style-type: none"> • Communication settings <p><u>PID control, single motor</u></p> <ul style="list-style-type: none"> • Feedback (AI2) scaling • Setpoint source • Constant setpoint <p><u>Hand mode</u></p>	
Auto control selection:	Where the drive gets the signal to switch between control locations (Ext1 and Ext2).	19.11 Ext1/Ext2 selection
Primary auto control location	Settings for the primary remote control location, Ext1. Enabling Ext1 gives a second set of start/stop/reference sources for remote control.	12.17 AI1 min 12.18 AI1 max
Secondary auto control location	Settings for the secondary remote control location, Ext2. These settings include reference source, start, stop, direction and command sources for Ext2. By default, Ext2 is set to Off .	19.11 Ext1/Ext2 selection 28.15 Ext2 frequency ref1 or 22.18 Ext2 speed ref1 12.17 AI1 min 12.18 AI1 max 12.27 AI2 min 12.28 AI2 max 20.06 Ext2 commands 20.08 Ext2 in1 source 20.09 Ext2 in2 source
Interlocks/permissives	Settings to prevent the drive from running or starting when a specific digital input is low. You can enter a custom text to use instead of “Run permissive”, “Start interlock 1”, “Start interlock 2”, “Start interlock 3” and “Start interlock 4”. See section Interlocks on page 141 .	20.40 Run permissive 20.41 Start interlock 1 20.42 Start interlock 2 20.43 Start interlock 3 20.44 Start interlock 4 20.45 Start interlock stop mode
Stop mode:	Sets how the drive stops the motor: with ramp or coast stop.	21.03 Stop mode

Menu item	Description	Corresponding parameter
Constant speeds / Constant frequencies	These settings are for using a constant value as the reference. By default, constant freq/speed 1 is activated by DI3 . See section Constant speeds/frequencies on page 131.	28.21 Constant frequency function or 22.21 Constant speed function 28.26 Constant frequency 1 28.27 Constant frequency 2 28.28 Constant frequency 3 22.26 Constant speed 1 22.27 Constant speed 2 22.28 Constant speed 3
Start mode:	Sets how the drive starts the motor. <ul style="list-style-type: none"> • Automatic • Ramp start (normal) • Ramp start with torque boost • Automatic + boost • Constant time pre-magnetization • Flying start • Flying start + torque boost 	21.01 Start mode 21.02 Magnetization time
Start delay:	Sets how the drive starts the motor.	21.22 Start delay

Motor

Off	ACQ580	0.0 Hz
Motor		
Nominal values		
Control mode	Scalar	
Start mode:	Ramp start (Normal)	
Phase order:	U V W	
Switching frequency	4 kHz	
Back	14:33	Select

Auto	ACQ580	35.5 rpm
Motor		
Nominal values		
Control mode	Vector	
ID run	Not done	
Start mode:	Flying start (Automatic)	
Phase order:	U V W	
Back	13:12	Select

Use the **Motor** submenu to adjust motor-related settings, such as nominal values, control mode or thermal protection.

Note that settings that are visible depend on other selections, for example, vector or scalar control mode, used motor type or selected start mode.

Three assistants are available: Control mode, Nominal value and ID run (for vector control mode only).

The table below provides detailed information about the available setting items in the **Motor** submenu.

Menu item	Description	Corresponding parameter
✕Nominal values	Enter the motor's nominal values from the motor's nameplate.	99.03 Motor type ... 99.12 Motor nominal torque
✕Control mode	Selects whether to use scalar or vector control mode. For information on scalar control mode, see section Scalar motor control on page 145. For information on vector control mode, see section Vector motor control on page 146.	99.04 Motor control mode
Start mode:	Sets how the drive starts the motor (for example, pre-magnetize or not). <ul style="list-style-type: none"> • Automatic • Ramp start (normal) • Ramp start with torque boost • Automatic + boost • Constant time pre-magnetization • Flying start • Flying start + torque boost 	21 Start/stop mode 21.02 Magnetization time
Phase order:	If the forward direction of the motor is wrong, change this setting to fix the direction instead of changing the phase order on the motor cable.	99.16 Motor phase order
Switching frequency	Sets the target and lowest allowed switching frequencies. For more information, see section Switching frequency on page 152.	97.01 Switching frequency reference 97.02 Minimum switching frequency
U/f ratio:	The form of voltage to frequency ratio below field weakening point. For more information, see section U/f ratio on page 148.	97.20 U/F ratio
IR compensation:	Sets how much to boost voltage at zero speed. Increase this for higher break-away torque. For more information, see section IR compensation for scalar motor control on page 145.	97.13 IR compensation
Pre-heating	Settings for motor preheating. The drive can prevent condensation in a stopped motor by feeding it a fixed current (% of motor nominal current). Use in humid or cold conditions to prevent condensation. For more information, see section Start methods – DC magnetization on page 150.	21.14 Pre-heating input source 21.16 Pre-heating current

Menu item	Description	Corresponding parameter
Thermal protection estimated	The settings in this submenu are meant to protect the motor from overheating by automatically triggering a fault or warning above a certain temperature. By default, motor thermal estimate protection is on. We recommend checking the values for the protection to function properly. For more information, see section Motor thermal protection on page 152.	35 Motor thermal protection
Thermal protection measured	The settings in this submenu are meant to protect the motor with a thermal measurement from overheating by automatically triggering a fault or warning above a certain temperature. For more information, see section Motor thermal protection on page 152.	35 Motor thermal protection
Stall protection	The settings in this submenu are meant to protect the motor in a stall situation. You can adjust the supervision limits (current, frequency and time) and choose how the drive reacts to a motor stall condition. For more information, see section Stall protection (parameters 31.24...31.28) on page 179.	31.24 Stall function 31.25 Stall current limit 31.26 Stall speed limit 31.27 Stall frequency limit 31.28 Stall time

4

■ Pump features

Off	ACQ580	0.0 Hz
Pump features		
Flow protection		▶
Pressure protection		▶
Dry pump protection		▶
Critical frequencies	Off	▶
Flow calculation	0.00 m ³ /h	▶
Back	14:29	Select

Use the **Pump features** submenu to adjust pump-related settings, such as pump protection functionalities, soft pipe fill or pump cleaning configurations.

The table below provides detailed information about the available setting items in the **Pump features** submenu.

Menu item	Description	Corresponding parameter
Flow protection	Configures the maximum and minimum values for the flow and flow protection.	80.15 Maximum flow 80.16 Minimum flow 80.17 Maximum flow protection 80.18 Minimum flow protection 80.19 Flow check delay

Menu item	Description	Corresponding parameter
Pressure protection	Configures settings for protection of the pump from too high or low pressure.	81.10 Inlet pressure source 81.11 Outlet pressure source 82.30 Outlet minimum pressure protection 82.31 Outlet minimum pressure warning level 82.35 Outlet maximum pressure protection 82.37 Outlet maximum pressure warning level 82.40 Inlet minimum pressure protection 82.41 Inlet minimum pressure warning level 82.45 Pressure check delay
Dry pump protection	Configures settings for dry pump protection. Dry pump protection function ensures that the water pump is not running without water and protects the pump from damaging.	82.20 Dry run protection 82.21 Dry run source
Critical speeds/frequencies	<p>Enables or disables the critical frequencies function.</p> <p>Determines whether the specified ranges are effective in both rotating directions or not.</p> <p>See also section Critical speeds/frequencies on page 132.</p>	28.51 Critical frequency function 28.52 Critical frequency 1 low 28.53 Critical frequency 1 high 28.54 Critical frequency 2 low 28.55 Critical frequency 2 high 28.56 Critical frequency 3 low 28.57 Critical frequency 3 high
Flow calculation	Configures the settings for sensor based or sensorless flow calculation functionality. Flow calculation measures the amount of water flowing based on the sensor feedback or without sensor based on the pump curve data.	80.12 Flow feedback 2 source 80.13 Flow feedback function 80.14 Flow feedback multiplier
Soft pipe fill	Configures settings for filling the pipeline with a gentle approach. This helps to avoid sudden pressure peaks and reduces the risk of water hammer which can cause damage to the water pipes.	40.14 Set 1 setpoint scaling 40.28 Set 1 setpoint increase time 40.29 Set 1 setpoint decrease time 82.25 Soft pipe fill supervision

Menu item	Description	Corresponding parameter
Pump cleaning	Configures the adjustments for pump cleaning functionality. Pump cleaning makes it possible to clean the pumps automatically when needed. This function reduces downtime and lowers manual cleaning costs. It also lowers pump's total running costs due to higher pump average operating efficiency.	83.11 Pump cleaning triggers 83.16 Cycles in cleaning program 83.20 Cleaning speed step 83.25 Time to cleaning speed 83.26 Time to zero-speed 83.27 Cleaning on time 83.28 Cleaning off time

PID control

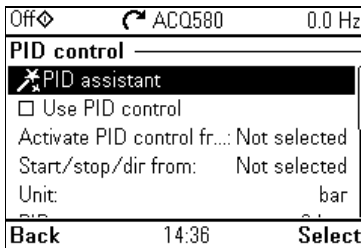

The **PID** submenu contains settings and actual values for the process PID controller. PID is only used in remote control.

See also section [Process PID control \(PID/Loop controller\)](#) on page 137.

The table below provides detailed information about the available setting items in the **PID** submenu.

Menu item	Description	Corresponding parameter
PID assistant	Configures secondary control location to use PID control. <u>Feedback</u> : AI2. Adjust the scaling of AI2 signal for feedback, if required. <u>Setpoint</u> : Select a constant value, control panel or AI1. If you selected AI2, adjust the scaling of AI1 signal for setpoint. <u>Start/stop</u> : DI	
Use PID control:	Select if PID control is used or not.	40.07 Process PID operation mode
Activate PID control from	Sets where the drive gets the signal to switch between control locations (Ext1 and Ext2)	19.11 Ext1/Ext2 selection

Menu item	Description	Corresponding parameter
Start/stop/dir from:	Selects the source for start, stop and direction.	20.01 Ext1 commands 20.02 Ext1 start trigger type 20.03 Ext1 in1 source 20.04 Ext1 in2 source 20.05 Ext1 in3 source 20.06 Ext2 commands 20.07 Ext2 start trigger type 20.08 Ext2 in1 source 20.09 Ext2 in2 source 20.10 Ext2 in3 source
Unit:	PID unit 1 (PID customer unit). Sets the text shown as the unit for setpoint, feedback and deviation.	
PID status:	View process PID status.	40.06 Process PID status word
Feedback:	View or configure process PID feedback, ie, the measured value.	40.02 Process PID feedback actual 40.08 Set 1 feedback 1 source 40.11 Set 1 feedback filter time
Setpoint:	View or configure the process PID setpoint, ie, the target process value. You can also use a constant setpoint value instead of (or in addition to) an external setpoint source. When a constant setpoint is active, it overrides the normal setpoint.	40.03 Process PID setpoint actual 40.16 Set 1 setpoint 1 source 40.26 Set 1 setpoint min 40.27 Set 1 setpoint max
Tuning	The Tuning submenu contains settings for gain, integration time and derivation time. 1. Make sure it is safe to start the motor and run the actual process. 2. Start the motor in remote control. 3. Change setpoint by a small amount. 4. Watch how feedback reacts. 5. Adjust gain/integration/derivation. 6. Repeat steps 3-5 until feedback reacts as desired.	40.04 Process PID deviation actual 40.32 Set 1 gain 40.33 Set 1 integration time 40.34 Set 1 derivation time 40.35 Set 1 derivation filter time
Increase output:	Select whether deviation means “feedback minus setpoint” or “setpoint minus feedback”: <ul style="list-style-type: none"> Feedback < Setpoint: Drive increases motor speed when feedback signal is below setpoint. Examples: Supply fan or pump. Feedback > Setpoint: Drive increases motor speed when feedback signal is greater than setpoint. Example: Cooling tower. 	40.31 Set 1 deviation inversion

Menu item	Description	Corresponding parameter
Output	View the process PID output or set its range.	40.01 Process PID output actual 40.36 Set 1 output min 40.37 Set 1 output max
Sleep function	The sleep function can be used to save energy by stopping the motor during low demand. By default, sleep function is disabled. If enabled, the motor automatically stops when demand is low, and starts again when deviation grows too large. This saves energy when rotating the motor at low speeds would be useless. See section Sleep and boost functions for process PID control on page 137.	40.43 Set 1 sleep level 40.44 Set 1 sleep delay 40.45 Set 1 sleep boost time 40.46 Set 1 sleep boost step 40.47 Set 1 wake-up deviation 40.48 Set 1 wake-up delay

■ Multipump control

Off	ACQ580	0.0 Hz
Pumping mode		
Select pumping mode to use:		
Off		
Intelligent pump control (IPC)		
Level control (filling)		
Level control (emptying)		
Back	14:37	Next

Off	ACQ580	0.0 Hz
Multipump control		
Pumping mode:	IPC	
Multipump comms (I2I) link:	EFB	
Settings for this pump		▶
Shared settings		▶
Back	15:21	Select

Off	ACQ580	0.0 Hz
Shared settings		
Total number of pumps:	1	
Always run at least:	1 pumps	
Never run more than:	1 pumps	
Transition smoothing		▶
Autochange		▶
Back	15:21	Select

Off	ACQ580	0.0 Hz
Configure Autochange		
Autochange triggered by:	Even wear	
Maximum wear imbalance:	10.00 h	
Maximum stationary time:	0.0 h	
Autochange allowed below:	100.0 %	
Back	15:21	Edit

Multipump (IPC, intelligent pump control) systems allows up to 8 drives to be connected to each other. This menu contains programming assistants for load sharing, balancing the run time between the pumps and keeping each pump running optimally.

If the active pumps cannot meet the demand, the system automatically starts or stops pumps one by one. Pump order can be set by the efficiency class of each pump (e.g. pumps with high efficiency are primarily used) or in order to balance the runtime (pumps which run the least, start first). This saves energy and extends the pump life time.

See also section [Pump control features](#) on page 99.

The table below provides detailed information about the available setting items in the **Multipump control** submenu.

Menu item	Description	Corresponding parameter
✕ Pumping mode	Selects the pumping mode. <ul style="list-style-type: none"> • Off • Intelligent pump control (IPC) • Level control (filling) (LC) • Level control (emptying) (LC) • Single pump control (PC) • Soft pump control (SPC) 	76.21 Multipump configuration
4 <i>For intelligent pump control (IPC) and level control (LC):</i> Pump node number	Node number:	76.22 Multipump node number
<i>For intelligent pump control (IPC) and level control (LC):</i> I21 configuration / Multipump comms (I21) link	Selects if EFB or FBMA-01 via FBA is used for communication.	76.24 IPC communication port
<i>For intelligent pump control (IPC) and level control (LC):</i> Settings for this pump	Drive name Node number Can be master Prefer this pump	76.22 Multipump node number 76.23 Master enable 76.77 Pump priority
<i>For intelligent pump control (IPC) and level control (LC):</i> Shared settings	✕ Synchronization settings Total number of pumps Efficient speed Always run at least: 1 pumps (<i>for IPC</i>) Never run more than: 8 pumps (<i>for IPC</i>) Start/stop from: (<i>for level control</i>) Level feedback (<i>for level control</i>) <ul style="list-style-type: none"> Measured level Measured level % Level source AI1 scaling AI2 scaling Level unit 	76.25 Number of motors 76.53 LC efficient speed 76.26 Min number of motors allowed 76.27 Max number of motors allowed 76.05 Measured level 76.06 Measured level % 76.51 LC level source 76.52 LC level unit

Menu item	Description	Corresponding parameter
<p><i>For intelligent pump control (IPC) and level control (LC):</i> Shared settings</p>	<p>Start/stop speeds (<i>for IPC</i>) / Start/stop levels (<i>for level control</i>) Start 2nd pump at: ... Start xth pump at: (as an example x = 4 = Total number of pumps) Stop xth pump at: ... Stop 1st pump at: Run full speed at: (<i>for level control</i>) Maximum time between levels: (<i>for level control</i>) Transition smoothing (<i>for IPC</i>) Ignore demand spikes under Ignore demand dips under Autochange Autochange triggered by: Even wear Maximum wear imbalance: 10.00 h Maximum stationary time: 0.0 h Autochange only below: 45 Hz (<i>for IPC</i>) PID control (<i>for IPC</i>) See PID control submenu on page 55.</p>	<p>76.30 Start point 1 ... 76.36 Start point 7 76.41 Stop point 1 ... 76.47 Stop point 7 76.55 Start delay 76.56 Stop delay 76.70 PFC Autochange 76.72 Maximum wear imbalance 76.76 Max stationary time 76.73 Autochange level</p>
<p><i>For single pump control (PC):</i> Configure pump control I/O</p>	<p>Number of motors: Include drive motor Contactor delay Configure RO:s PC2 is controlled by: ... PC6 is controlled by: Configure interlocks PC1 is interlocked by: ... PC6 is interlocked by Check I/O configuration See I/O menu on page 74.</p>	<p>76.25 Number of motors 76.59 PFC contactor delay 10.24 RO1 source 10.27 RO2 source 10.30 RO3 source 15.07 RO4 source 15.10 RO5 source 15.13 RO6 source 76.81 PFC 1 interlock 76.82 PFC 2 interlock 76.83 PFC 3 interlock 76.84 PFC 4 interlock 76.85 PFC 5 interlock 76.86 PFC 6 interlock</p>

Menu item	Description	Corresponding parameter
For soft pump control (SPC): Configure pump control	PC Start, stop, reference Secondary auto control location Start/stop from: Reference from: Configure Process PID: See PID control submenu on page 55. Aux motors started at: Aux motors stopped at: Start delay: Stop delay:	76.55 Start delay 76.56 Stop delay
For single pump control (PC) and for soft pump control (SPC): Configure Autochange	Autochange triggered by: Fixed interval: (for fixed interval) Maximum wear imbalance: (for even wear) Autochange allowed below:	76.70 PFC Autochange 76.71 PFC Autochange interval 76.72 Maximum wear imbalance

Ramps

Off	ACQ580	0.0 Hz
Ramps		
Quick ramps ▶		
Acceleration time:	5.000 s	
Deceleration time:	5.000 s	
Stop mode:	Coast	
Ramp time target frequency:	50.00 Hz	
Back	14:37	Select

Use the **Ramps** submenu to set up acceleration and deceleration settings.

See also section [Ramps](#) on page 135.

Note: To set ramps, you also have to specify parameter [46.01 Speed scaling](#) (in speed control mode) or [46.02 Frequency scaling](#) (in frequency control mode).

The table below provides detailed information about the available setting items in the **Ramps** submenu.

Menu item	Description	Corresponding parameter
Quick ramps	The quick ramp function allows you to use two additional ramp sets to accelerate or decelerate the pump. See also section Ramps – Quick ramps on page 128.	82.01 Quick ramp accel. mode 82.05 1st quick ramp accel. time 82.06 Final quick ramp decel. time 82.07 1st quick ramp accel. limit 82.10 2nd quick ramp accel. time 82.11 2nd quick ramp decel. time 82.12 2nd quick ramp accel. limit
Acceleration time:	This is the time between standstill and “scaling speed” when using the default ramps (set 1).	23.12 Acceleration time 1 28.72 Freq acceleration time 1
Deceleration time:	This is the time between standstill and “scaling speed” when using the default ramps (set 1).	23.13 Deceleration time 1 28.73 Freq deceleration time 1
Stop mode:	Sets how the drive stops the motor.	21.03 Stop mode
Ramp time target frequency:	Sets the maximum frequency for acceleration = the initial frequency for deceleration. For scalar control mode.	46.02 Frequency scaling
Ramp time target speed:	Sets the maximum speed for acceleration = the initial speed for deceleration. For vector control mode	46.01 Speed scaling

Limits

Off	ACQ580	0.0 Hz
Limits		
Minimum frequency:	0.00 Hz	
Maximum frequency:	50.00 Hz	
Maximum current:	2.92 A	
Back	14:37	Edit

Use the **Limits** submenu to set the allowed operating range. This function is intended to protect the motor, connected hardware and mechanics. The drive stays within these limits, no matter what reference value it gets. See section [Fieldbus](#) on page 62.

See also section [Limits](#) on page 140.

Note: These limit parameters have no effect on ramps.

The table below provides detailed information about the available setting items in the **Limits** submenu.

Menu item	Description	Corresponding parameter
Minimum frequency:	Sets the minimum operating frequency. Affects scalar control only.	30.13 Minimum frequency
Maximum frequency:	Sets the maximum operating frequency. Affects scalar control only.	30.14 Maximum frequency
Minimum speed:	Sets the minimum operating speed. Affects vector control only.	30.11 Minimum speed
Maximum speed:	Sets the maximum operating speed. Affects vector control only.	30.12 Maximum speed
Minimum torque:	Sets the minimum operating torque. Affects vector control only.	30.19 Minimum torque 1
Maximum torque:	Sets the maximum operating torque. Affects vector control only.	30.20 Maximum torque 1
Maximum current:	Sets the maximum output current.	30.17 Maximum current

Fieldbus

Off	ACQ580	0.0 Hz
Fieldbus		
Embedded fieldbus None / IPC co... ▶		
Fieldbus adapter		Not used ▶
Back	14:38	Select

Use the **Fieldbus** menu to set up and view communication through embedded fieldbus or fieldbus adapter.

Embedded fieldbus

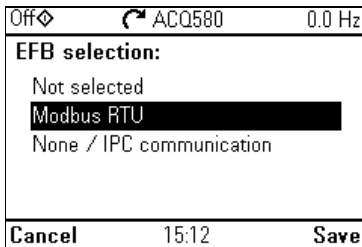
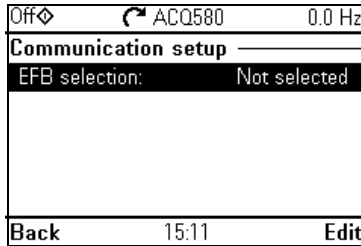
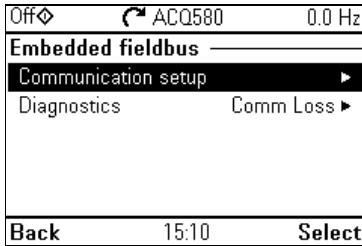

Use the settings in the **Embedded fieldbus** submenu to use the drive with the Modbus RTU protocol.

You can also configure all the embedded fieldbus related settings via the parameters (parameter group [58 Embedded fieldbus](#)), but the purpose of the **Embedded fieldbus** submenu is to make the protocol configurations easier.

See also chapter [Fieldbus control through a fieldbus adapter](#) on page [223](#).

The table below provides detailed information about the available setting items in the **Embedded fieldbus** submenu. Note that some of the items only become active once you have enabled embedded fieldbus.

Menu item	Description	Corresponding parameter
EFB selection	Select the protocol you want to use.	58.01 Protocol enable
Communication setup	To set up communication between the drive and the fieldbus master, define these settings and then select Apply settings to embedded fieldbus module .	58 Embedded fieldbus 58.03 Node address (Station ID) 58.04 Baud rate Modbus RTU: 58.05 Parity Modbus RTU: 58.25 Control profile 58.15 Communication loss mode 58.16 Communication loss time 58.06 Communication control

Menu item	Description	Corresponding parameter
Diagnostics	<p>Diagnose embedded fieldbus communication, such as status, load of communication and message counters.</p> <ul style="list-style-type: none"> Actual status: Status value: EFB data from client View what the drive EFB receives from the fieldbus master (PLC/SCADA). EFB data to client View what the drive EFB sends to the fieldbus master (PLC/SCADA). 	<p>58.07 Communication diagnostics</p> <p>58.08 Received packets</p> <p>58.11 UART errors</p> <p>58.12 CRC errors</p> <p>58.18 EFB control word</p> <p>03.09 EFB reference 1</p> <p>58.09 Transmitted packets</p> <p>58.19 EFB status word</p>

Fieldbus adapter

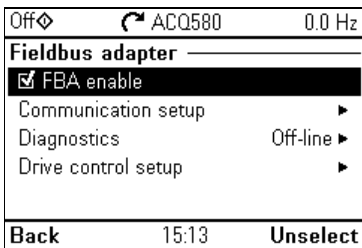

Use the settings in the **Fieldbus adapter** submenu to use the drive with the following fieldbus protocols, shown with the optional fieldbus adapter module required:

- CANopen: FCAN-01 adapter
- DeviceNet: FDNA-01 adapter
- Ethernet/IP: FEIP-21 adapter, FENA-21 adapter
- ModbusTCP: FMBT-21 adapter, FENA-21 adapter
- PROFIBUS-DB: FBPA-01 adapter
- PROFINET IO: FPNO-21 adapter, FENA-21 adapter
- Ethernet/IP: FENA-21 adapter

Check the supported fieldbus modules with your ABB representative.

You can also configure all the fieldbus related settings via the parameters (parameter groups [50 Fieldbus adapter \(FBA\)](#), [51 FBA A settings](#), [52 FBA A data in](#), [53 FBA A data out](#), [58 Embedded fieldbus](#), but the purpose of the **Fieldbus adapter** submenu is to make the protocol configurations easier.

See also chapter [Fieldbus control through a fieldbus adapter](#) on page [253](#).

The table below provides detailed information about the available setting items in the **Fieldbus adapter** submenu. Note that some of the items only became active once you have enabled fieldbus.

Menu item	Description	Corresponding parameter
Fieldbus adapter	FBA enable: Select this if you want to use the drive with a fieldbus adapter.	50.01 FBA A enable
Communication setup	Select the module (protocol). To set up communication between the drive and the fieldbus master, define these settings and then select Apply settings to fieldbus module .	51.01 FBA A type 58.01 Protocol enable 51 FBA A settings 51.01 FBA A type 51.02 FBA A Par2 51.27 FBA A par refresh 51.31 D2FBA A comm status 50.13 FBA A control word 50.16 FBA A status word 51.27 FBA A par refresh
Diagnostics	Diagnose fieldbus communication, such as status, load of communication and message counters. Information on FBA A data from master and to master.	
Drive control setup	Sets how a fieldbus master can control this drive, and how the drive reacts if the fieldbus communication fails. Define these settings and then select Apply settings to fieldbus module .	20.01 Ext1 commands 19.11 Ext1/Ext2 selection 22.11 Ext1 speed ref1 28.11 Ext1 frequency ref1 22.41 Speed ref safe 28.41 Frequency ref safe 50.03 FBA A comm loss t out 46.01 Speed scaling 46.02 Frequency scaling 23.12 Acceleration time 1 23.13 Deceleration time 1 28.72 Freq acceleration time 1 28.73 Freq deceleration time 1 51.27 FBA A par refresh

Fault functions

Off	ACQ580	0.0 Hz
Fault functions		
Autoreset faults		On ▶
<input checked="" type="checkbox"/> Additional fault reset		
Reset from keypad and	D13	①
Back	20:31	Select

4

The **Fault functions** submenu contains settings for resetting faults automatically or manually.

Menu item	Description	Corresponding parameter
Autoreset faults	Reset faults automatically. For more information, see section Sleep and boost functions for process PID control on page 137.	31.12 Autoreset selection 31.14 Number of trials 31.15 Total trials time 31.16 Delay time
Additional fault reset	You can reset an active fault via I/O: a rising pulse in the selected input means reset. A fault can be reset from the fieldbus even if Reset faults manually is unselected.	31.11 Fault reset selection
Reset from keypad and...	Define from where you want to reset faults manually. Note that this submenu is active only if you have selected to reset faults manually.	31.11 Fault reset selection
If EFB communication fails:	Define action to be taken if EFB communication fails.	58.14 Communication loss action
If EFB communication under monitoring:	Define which message types reset the timeout counter for detecting an EFB communication loss.	58.15 Communication loss mode
Ignore EFB failures shorter than:	Define a timeout for EFB communication. If a communication break lasts longer than the timeout, the action specified in If EFB communication fails : is taken.	58.16 Communication loss time

Security



The **Security** submenu is a protected menu that you can open with the user pass code. The menu lets you prevent actions and functionalities with the user lock. You can also change the user lock pass code.

See also section [User lock](#) on page [184](#).

Menu item	Description	Corresponding parameter
Unlock this menu / Lock this menu	You have to enter the user passcode to unlock the menu. The default passcode is "10000000". While you have the user lock open, warning <i>A6B0 User lock is open</i> is active. After making your changes in the menu, select row Lock this menu and press Select .	96.02 Pass code
Lock all parameters Disable backup and restore Disable OEM access level Disable ABB access level Disable file download		96.102 User lock functionality
Change security passcode	Note: You must change the default user pass code to maintain a high level of cybersecurity. <u>Store the code in a safe place – ABB CANNOT UNLOCK THE DRIVE ONCE YOU CHANGE THE PASS CODE.</u> Enter first the new passcode and then re-enter the new passcode to confirm it.	96.02 Pass code 96.100 Change user pass code 96.101 Confirm user pass code

Advanced functions

Off	ACQ580	0.0 Hz
Advanced functions		
External events		▶
Supervision		▶
Timed functions	Disabled	▶
User sets		▶
First start assistant		
Back	14:39	Select

4

The **Advanced functions** submenu contains settings for advanced functions, such as triggering or resetting custom faults via I/O, signal supervision, using the drive with timed functions, or switching between several entire sets of settings. In addition you can run the First start assistant from this submenu.

The table below provides detailed information about the available setting items in the **Advanced functions** submenu.

Menu item	Description	Corresponding parameter
External events	Enables you to define custom faults or warnings you can trigger via digital input. The texts of these messages are customizable. For more information, see section External events on page 131 .	31.01 External event 1 source 31.02 External event 1 type 31.03 External event 2 source 31.04 External event 2 type 31.05 External event 3 source 31.06 External event 3 type 31.07 External event 4 source 31.08 External event 4 type 31.09 External event 5 source 31.10 External event 5 type

Menu item	Description	Corresponding parameter
Supervision	<p>You can select three signals to be supervised. If a signal is outside predefined limits a fault or warning is generated. For complete settings, see group 32 Supervision on page 403.</p> <p>For more information, see section Signal supervision on page 173.</p>	32.01 Supervision status 32.05 Supervision 1 function 32.06 Supervision 1 action 32.07 Supervision 1 signal 32.09 Supervision 1 low 32.10 Supervision 1 high 32.11 Supervision 1 hysteresis... 32.25 Supervision 3 function 32.26 Supervision 3 action 32.27 Supervision 3 signal 32.29 Supervision 3 low 32.30 Supervision 3 high 32.31 Supervision 3 hysteresis
Timed functions	<p>Enables using the drive with timed functions. For complete settings, see group 34 Timed functions on page 410.</p> <p>For more information, see section Timed functions on page 133.</p>	34.100 Timed function 1 34.101 Timed function 2 34.102 Timed function 3 34.111 Boost time activation source 34.112 Boost time duration 34.11 Timed functions enable 34.11 Timer 1 configuration 34.12 Timer 1 start time 34.13 Timer 1 duration ... 34.44 Timer 12 configuration 34.45 Timer 12 start time 34.46 Timer 12 duration
User sets	<p>This submenu enables you to save four sets of settings for easy switching.</p> <p>For more information about user sets, see section Data storage parameters on page 183.</p>	96.11 User set save/load 96.10 User set status 96.12 User set I/O mode in1 96.13 User set I/O mode in2

Menu item	Description	Corresponding parameter
Confirmation for HAND/OFF	<p>Selects if you want to add confirmation for Hand and Off buttons so that they need to be pressed twice within five seconds to operate. The control panel shows a message about pressing twice after the first press.</p> <p>This selection can be used to prevent accidental Hand and Off button presses.</p> <p>If Hand and/or Off buttons are disabled with parameters 19.18 HAND/OFF disable source and 19.19 HAND/OFF disable action, this setting has no effect.</p>	

■ Clock, region, display

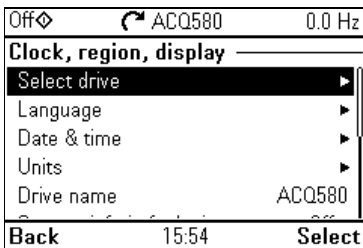

The **Clock, region, display** submenu contains settings for language, date and time, display (such as brightness) and settings for changing how information is displayed on screen.

The table below provides detailed information about the available setting items in the **Clock, region, display** submenu.

Menu item	Description	Corresponding parameter
Select drive	<p>If more than one drive is connected to this control panel, select the drive to be controlled here.</p> <p>To see the other drives, set <i>Panel bus</i> to <i>On</i> and enable networking in the parameters of each drive.</p>	
Language	<p>Change the language used on the control panel screen. Note that the language is loaded from the drive so this takes some time.</p> <p>Available languages vary depending on the drive firmware language package installed: Standard language package, European language package or Asian language package. Parameter 07.10 Language file set shows the language package in use.</p>	96.01 Language
Date & time	Set the time and date, and their formats.	

Menu item	Description	Corresponding parameter
Units	Select the units used for power, temperature, torque and currency.	96.16 <i>Unit selection</i>
Drive name	The drive name defined in this setting is shown in the PC tool and at the status bar at the top of the control panel screen while using the drive. If more than one drives are connected to the control panel, the drive names make it easy to identify each drive. It also identifies any backups you create for this drive.	
Contact info in fault view	Define a fixed text that is shown during any fault (for example, who to contact in case of a fault). If a fault occurs, this information appears on the control panel screen (in addition to the fault-specific information).	
Edit texts	Set the drive name, adjust currency unit and PID unit, and edit Start interlocks 1...4, Run permissive, Signal supervisions 1...3, External faults 1...3, Contact info.	
Display settings	Adjust the brightness, contrast and display power save delay of the control panel screen or to invert white and black.	
Show in lists	Show or hide the numeric IDs of: <ul style="list-style-type: none"> • parameters and groups • option list items • bits • devices in Options > Select drive 	
Edit Home view	Select the parameters displayed in the Home view, with display style, decimals, name, unit, minimum and maximum.	
Show inhibit pop-up	Enables or disables pop-up views showing information on inhibits, for example, when you try to start the drive but it is prevented.	

Reset to defaults

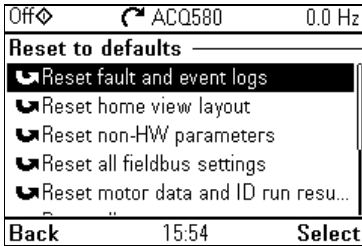

4

The **Reset to defaults** submenu enables you to reset parameters and other settings.

Menu item	Description	Corresponding parameter
Reset fault and event logs	Clears all events from the drive's fault and event logs.	96.51 Clear fault and event logger
Reset home view layout	Restores the home view layout back to show the values of the default parameters defined by the selected control macro.	96.06 Parameter restore , selection Reset home view
Reset non-HW parameters	Restores all editable parameter values to default values, except <ul style="list-style-type: none"> motor data and ID run results I/O extension module settings end user texts, such as customized warnings and faults, and the drive name control panel/PC communication settings fieldbus adapter settings parameter 95.01 Supply voltage parameters 95.20 HW options word 1 and 95.21 HW options word 2 user lock configuration parameters 96.100...96.102. 	96.06 Parameter restore , selection Restore defaults
Reset all fieldbus settings	Restores all fieldbus and communication related settings to default values. Note: Fieldbus, control panel and PC tool communication are interrupted during the restore.	96.06 Parameter restore , selection Reset all fieldbus settings
Reset motor data and ID run results	Restores all motor nominal values and motor ID run results to default values.	96.06 Parameter restore , selection Reset motor data

Menu item	Description	Corresponding parameter
Reset all parameters	Restores all editable parameter values to default values, except <ul style="list-style-type: none"> • end user texts, such as customized warnings and faults, and the drive name • control panel/PC communication settings • parameter 95.01 Supply voltage • differentiated defaults implemented by parameters 95.20 HW options word 1 and 95.21 HW options word 2 and the differentiated defaults implemented by them • user lock configuration parameters 96.100...96.102 • group 49 Panel port communication parameters. 	96.06 Parameter restore , selection Clear all
Reset end user texts	Restores all end user texts to default values, including the drive name, contact info, customized fault and warning texts, PID unit and currency unit. Note: PID unit is reset only if it is user editable text, that is, parameter 40.79 Set 1 units is set to User text.	96.06 Parameter restore , selection Reset end user texts
Reset first start assistant	Resets the first start assistant so that at the next time drive is powered on the first start assistant is shown.	
Reset all to factory defaults	Restores all drive parameters and settings back to initial factory values, except <ul style="list-style-type: none"> • parameters 95.20 HW options word 1 and 95.21 HW options word 2 and the differentiated defaults implemented by them. 	96.06 Parameter restore , selection All to factory defaults

I/O menu

Off	ACQ580	0.0 Hz
I/O		
DI1: 1		Start/stop ▶
DI2: 0		Not used ▶
DI3: 0	Used in several places ▶	
DI4: 0		Not used ▶
DI5: 1		Not used ▶
Back	15:54	Select

4

To go the **I/O** menu from the Home view, select **Menu > I/O**.

Use the **I/O** menu to make sure that the actual I/O wiring matches the I/O use in the control program. It answers the questions:

- What is each input being used for?
- What is the meaning of each output?

You can configure, add and remove use of inputs and outputs.

In the **I/O** menu, each row provides the following information:

- Terminal name and number
- Electrical status
- Logical meaning of the drive

Each row also provides a submenu that provides further information on the menu item and lets you make changes to the I/O connections.

The table below provides detailed information about the contents of the different submenus available in the **I/O** menu.

Menu item	Description
DI1	This submenu lists the functions that use DI1 as input.
DI2	This submenu lists the functions that use DI2 as input.
DI3	This submenu lists the functions that use DI3 as input.
DI4	This submenu lists the functions that use DI4 as input.
DI5	This submenu lists the functions that use DI5 as input.
DI6	This submenu lists the functions that use DI6 or FI as input. The connector can be used as either digital input or frequency input.
AI1	This submenu lists the functions that use AI1 as input.
AI2	This submenu lists the functions that use AI2 as input.
RO1	This submenu lists what information goes into relay output 1.
RO2	This submenu lists what information goes into relay output 2.
RO3	This submenu lists what information goes into relay output 3.
AO1	This submenu lists what information goes into AO1.
AO2	This submenu lists what information goes into AO2.
I/O extension	This submenu has the following submenus:
RO4	This submenu lists what information goes into relay output 4.

Menu item	Description
RO5	This submenu lists what information goes into relay output 5.
RO6	This submenu lists what information goes into relay output 6.
RO7	This submenu lists what information goes into relay output 7.
DO1	This submenu lists what information goes into digital output 1.

Diagnostics menu

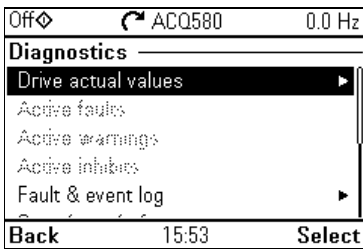

4

To go the **Diagnostics** menu from the Home view, select **Menu > Diagnostics**.

The **Diagnostics** menu provides you with diagnostic information, such as faults and warnings, and helps you to resolve potential problems. Use the menu to make sure that the drive setup is functioning correctly.

To clear the fault and event logger, select **Menu > Primary settings > Reset to defaults > Reset fault and event logs**, or set parameter [96.51 Clear fault and event logger](#) to value [Reset](#).

The table below provides detailed information about the contents of the different views available in the **Diagnostics** menu.

Menu item	Description
Drive actual values	Shows actual values: 01.01 Motor speed used , 01.06 Output frequency , 01.07 Motor current , 01.10 Motor torque , 01.11 DC voltage , 01.13 Output voltage , 01.14 Output power , 06.01 Main control word , 06.11 Main status word , 19.01 Actual operation mode , 05.01 On-time counter , 05.02 Run-time counter , 05.04 Fan on-time counter , 05.10 Control board temperature , 05.11 Inverter temperature , 35.01 Motor estimated temperature , 35.02 Measured temperature 1 , 35.03 Measured temperature 2 , 40.01 Process PID output actual , 40.02 Process PID feedback actual , 40.03 Process PID setpoint actual , 40.04 Process PID deviation actual , 40.07 Process PID operation mode .
Active faults	This view shows the currently active faults and provides instructions on how to fix and reset them.
Active warnings	This view shows the currently active warnings and provides instructions on how to fix them.
Active inhibits	This view shows up to five simultaneous active start inhibits and how to fix them.
Fault & event log	This view lists the faults, warnings and other events that have occurred in the drive. Press Details to see, for each stored fault, the fault code, time and values of nine parameters (actual signals and status words) stored at the time of the fault. The values of the parameters for the latest fault are in parameters 05.80...05.89 .

Menu item	Description
Start, stop, reference summary	This view shows where the drive is currently taking its start and stop commands and reference. The view is updated in real time. If the drive is not starting or stopping as expected, or runs at an undesired speed, use this view to find out where the control comes from.
Limit status	This view describes any limits currently affecting operation. If the drive is running at undesired speed, use this view to find out if any limitations are active.
Load profile	This view shows results of the load analyzer. Amplitude loggers show load distribution diagrams: how much of the drive's running time was spent at each load level. The peak value logger lists maximum momentary load levels.
Communication status	This view provides status information and sent and received data from fieldbus for troubleshooting.
Motor summary	This view provides motor information: nominal values, control mode and whether ID run has been completed.

System info menu

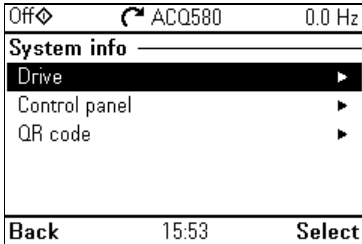

4

To go the **System info** menu from the Home view, select **Menu > System info**.

The **System info** menu shows information of the drive and the control panel. In problem situations you can also request the drive to generate a QR code for ABB service, so they can better assist you.

The table below provides detailed information about the available setting items in the **System info** menu.

Menu item	Description	Corresponding parameter
Drive	Panel bus id: Serial number: Manufacturing date: Product name: Product type: LP version: Backup version: FW version: Note: If no data was loaded in the factory, some information (for example, serial number) will not appear in the drive information.	07.07 Loading package version 07.05 Firmware version
Control panel	Product type: HW version: FW version: Serial number: Manufacturing date:	
QR code	The drive generates a QR code (or a series of QR codes), which contains drive identification data, information on the latest events, and values of status and counter parameters. You can read the QR code with a mobile device containing the ABB application, which then sends the QR code to ABB for analysis.	

Energy efficiency menu

Off	ACQ580	0.0 Hz
Energy efficiency		
Total energy saved	0.0 kWh	▶
Used, last hour	0.00 kWh	▶
Used, last day	0.00 kWh	▶
Used, last month	0.00 kWh	▶
Used, total	0.0 kWh	▶
Back	15:53	Select

To go the **Energy efficiency** menu from the Home view, select **Menu > Energy efficiency**.

Use the **Energy efficiency** menu to view energy and power values, view and change settings of the load analyzer (= amplitude and peak value loggers), for example, view graphical representation of the two amplitude loggers, as well as and change energy calculation settings.

See also sections [Energy efficiency](#) on page 175 and [Load analyzer](#) on page 176.

The table below provides detailed information about the available setting items in the **Energy efficiency** menu.

Menu item	Description	Corresponding parameter
Total energy saved	Energy saved in kWh compared to direct-on-line motor connection. Corresponding money saved. Corresponding CO ₂ saved.	45.04 Saved energy 45.07 Saved amount 45.10 Total saved CO2
Used, last hour	Energy used during the last hour (the last 60 minutes). Average power during the last hour (value of 45.26 divided by one hour).	45.26 Hourly total energy (resettable)
Used, last day	Energy used during the previous day (between midnight of the previous day and midnight of the present day). Average power during the last day (value of 45.30 divided by 24 hours).	45.30 Last day total energy
Used, last month	Energy used during the previous month (between midnight of the first day or the previous month and midnight of the first day of the present month). Average power during the last month (value of 45.30 divided by 732 hours).	45.35 Last month total energy
Used, total	All-time total used energy Resettable total used energy	01.54 Cumulative inverter energy 01.58 Cumulative inverter energy (resettable)

Menu item	Description	Corresponding parameter
Peak power	Hourly peak power (during the last 60 minutes) Time of the hourly peak power Daily peak power (during the previous day) Time of the daily peak power Monthly peak power (during the previous month) Time of the monthly peak power Date of the monthly peak power All-time peak power Time of all time peak power Date of all time peak power	45.24 Hourly peak power value 45.25 Hourly peak power time 45.27 Daily peak power value (resettable) 45.28 Daily peak power time 45.31 Monthly peak power value (resettable) 45.33 Monthly peak power time 45.32 Monthly peak power date 45.36 Lifetime peak power value 45.38 Lifetime peak power time 45.37 Lifetime peak power time
Load profile	Amplitude logger 1 (graphical representation) Amplitude logger 2 (graphical representation) Amplitude loggers show load distribution diagrams: how much of the drive's running time was spent at each load level. Load profile configuration Peak value logger The peak value logger lists maximum momentary load levels.	36.06 AL2 signal source 36.07 AL2 signal scaling 36.09 Reset loggers 36.01 PVL signal source 36.02 PVL filter time 36.10 PVL peak value 36.11 PVL peak date 36.12 PVL peak time 36.13 PVL current at peak 36.14 PVL DC voltage at peak 36.15 PVL speed at peak 36.16 PVL reset date 36.17 PVL reset time
Calculation settings	Energy optimizer Energy tariff 1 Energy tariff 2 Tariff selection CO ₂ conversion Comparison power Reset saved energy counters Reset total used counter	45.11 Energy optimizer (Disable or Enable) 45.12 Energy tariff 1 45.13 Energy tariff 2 45.14 Tariff selection 45.18 CO₂ conversion factor 45.19 Comparison power 45.21 Energy calculations reset Enter 0 to 01.58 Inverter kWh counter (resettable)

Backups menu

Auto	ACQ580	5.0 bar
Backups		
Create backup ▶		
ACQ580 04.04.2019	autobackup	▶
ACQ580 05.09.2018		▶
ACQ580 12.09.2016		▶
Back	13:29	Select

Auto	ACQ580	5.0 bar
ACQ580 05.09.2018		
View backup contents ▶		
Restore all parameters		
Select par restore group ▶		
Select user sets ▶		
Select prod. data items ▶		
Back	13:29	Select

To go to the **Backups** menu from the Home view, select **Backups**.

For backups and restores, see section [Backup and restore](#) on page 182.

4

Options menu

Off	ACQ580	0.0 Hz
Output frequency	0.00	Hz
Motor current	0.00	A
Motor torque	0.0	%
Options	12:11	Menu

Auto	ACQ580	0.0 Hz
Options		
Reference ▶		
Select drive ▶		
Edit Home view ▶		
Active faults		
Active warnings		
Exit	12:11	Select

To go to the **Options** menu, press the **Options** softkey (☐) in any of the Home view displays. The table below provides information about the different options available in the **Options** menu.

Menu item	Description	Description
Reference	You can change the reference, which is visible on the top right corner of the panel displays.	
Direction change	Alters the sign of active reference between positive and negative. Absolute value of reference is not changed.	
Select drive	You can select a drive that you want to monitor or control from the list of drives showing the drives connected on the panel bus. You can also clear the list of drives.	

Menu item	Description	Description
<p data-bbox="79 161 288 183">Edit Home view</p>	<p data-bbox="288 161 773 272">You can edit the Home view displays. Scroll with the arrow keys (◀) and (▶) to the Home view you want to edit. Select the display slot, that is, which of the current parameter(s) you want to edit (Home views show one to three parameters). Edit the parameter and how you want to display it.</p> <div data-bbox="300 277 658 520" style="border: 1px solid black; padding: 5px;"> <p data-bbox="300 277 658 304">Auto ACQ580 81.1 °C</p> <p data-bbox="300 309 658 368">Output frequency 0.00 Hz</p> <p data-bbox="300 373 658 432">Motor current 0.00 A</p> <p data-bbox="300 437 658 488">AIT actual value 8.110 V</p> <p data-bbox="300 493 658 520">Done 13:55 Edit</p> </div> <div data-bbox="300 533 658 775" style="border: 1px solid black; padding: 5px;"> <p data-bbox="300 533 658 560">Auto ACQ580 81.1 °C</p> <p data-bbox="300 564 658 592">Display slot —</p> <p data-bbox="300 596 658 624">Parameter: Motor current</p> <p data-bbox="300 628 658 655">Display style: Numeric</p> <p data-bbox="300 660 658 687">Display decimals: 2</p> <p data-bbox="300 692 658 719">Display name: "Motor current"</p> <p data-bbox="300 724 658 751">Min: 0.00 A</p> <p data-bbox="300 756 658 775">Done 13:57 Edit</p> </div>	
Active faults	Shows the active faults.	
Active warnings	Shows the active warnings.	
Active inhibits	Shows the active inhibits.	



5

Default I/O configuration

5

Contents of this chapter

This chapter describes the intended use, operation and default control connections of the application.

Water default

This is the default configuration of control connections for water and waste water applications.

Default control connections for the Water default

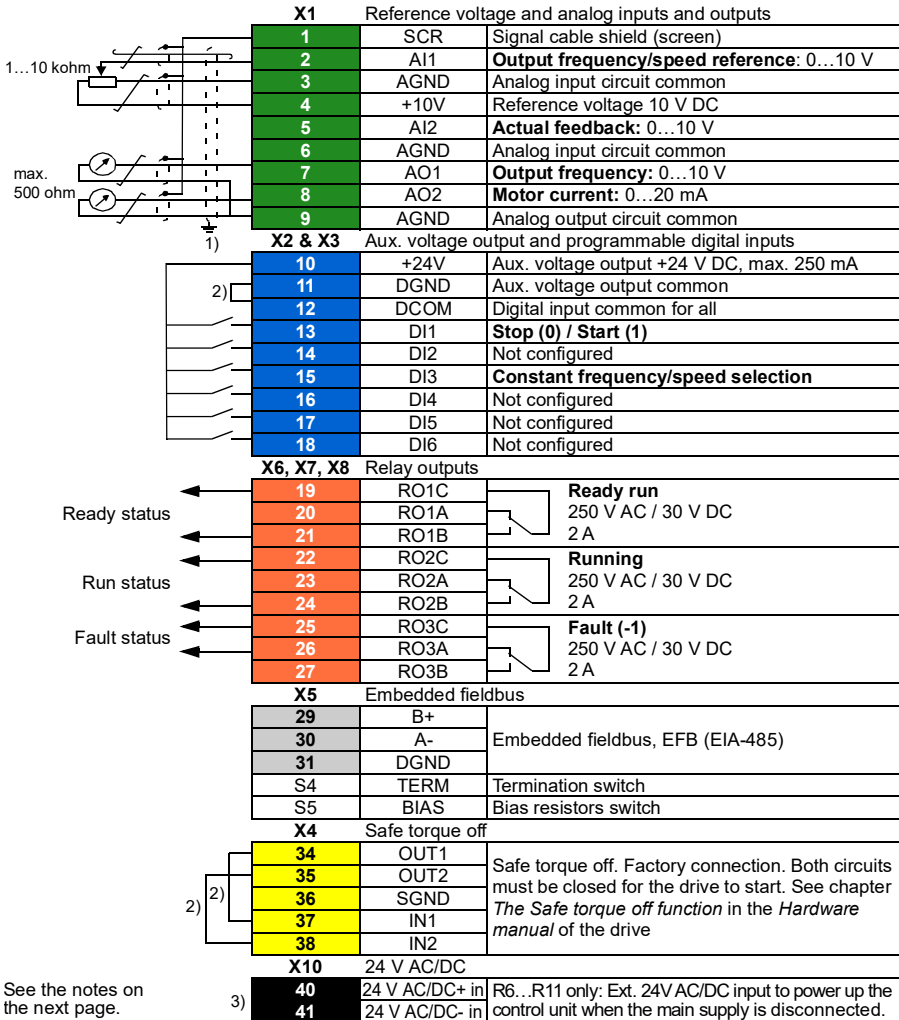

Terminal sizes:

R1...R5: 0.2...2.5 mm² (24...14 AWG): Terminals +24V, DGND, DCOM, B+, A-, DGND,
Ext. 24V

0.14...1.5 mm² (26...16 AWG): Terminals DI, AI, AO, AGND, RO, STO

R6...R11: 0.14...2.5 mm²: All terminals

Tightening torques: 0.5...0.6 N·m (0.4 lbf·ft)

Notes:

- 1) Ground the outer shield of the cable 360 degrees under the grounding clamp on the grounding shelf for the control cables.
- 2) Connected with jumpers at the factory.
- 3) Only frames R6...R11 have terminals 40 and 41 for external 24 V AC/DC input.

Input signals

- Analog frequency reference (AI1)
- Start/stop selection (DI1)
- Constant speed/frequency selection (DI3)

Output signals

- Analog output AO1: Output frequency
- Analog output AO2: Motor current
- Relay output 1: Ready run
- Relay output 2: Running
- Relay output 3: Fault (-1)

6

Program features

What this chapter contains

This chapter describes some of the more important functions within the control program, how to use them and how to program them to operate. It also explains the control locations and operating modes.

6

Local control vs. external control

The ACQ580 has two main control locations: external and local. In local control there are two different modes: Off and Hand.

In the Off mode, the drive is stopped. In the Hand mode, the drive is running. The initial reference in the Hand mode is copied from the drive reference.

The following diagram shows the state transitions when you press the Hand, Off or Auto button:

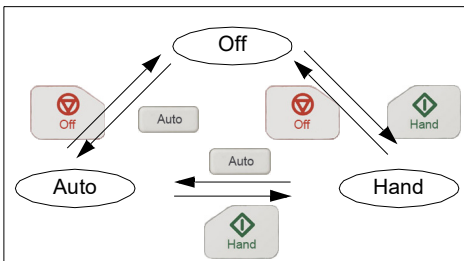

The control location can also be selected in the PC tool.

Note: If fault [7081 Control panel loss](#) is active and the drive is powered down, the mode changes to Auto when power is reapplied.

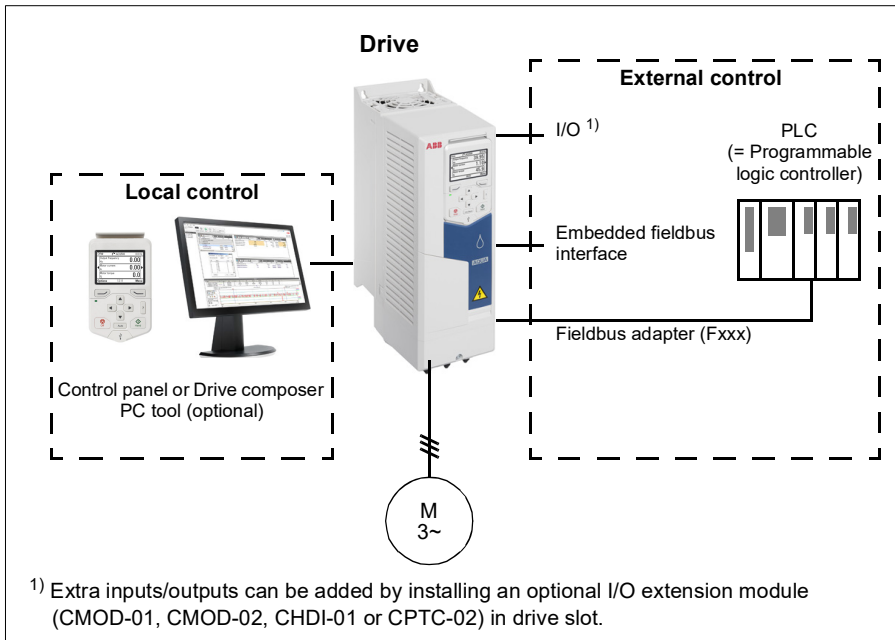

Local control

When the drive is in local control, control commands are given through

- the control panel keypad
- a PC equipped with Drive composer PC tool.

Speed control mode is available in vector motor control mode; frequency mode is available when scalar motor control mode is used.

Local control is mainly used during commissioning and maintenance. The control panel always overrides the external control signal sources when used in local control. Changing the control location to local can be prevented by parameter [19.18 HAND/OFF disable source](#).

The user can select with parameter [49.05 Communication loss action](#) how the drive reacts to a control panel or PC tool communication loss. (The parameter has no effect in external control.)

External control

When the drive is in external control, control commands are given through

- the I/O terminals (digital and analog inputs), or optional I/O extension modules
- the fieldbus interface (via the embedded fieldbus interface or an optional fieldbus adapter module).

Two external control locations, EXT1 and EXT2, are available. The user can select the sources of the start and stop commands separately for each location by setting parameters [20.01 Ext1 commands...](#)[20.09 Ext2 in2 source](#). The operating mode can be selected separately for each location, which enables quick switching between different operating modes, for example, speed and process PID control. Selection between EXT1 and EXT2 is done via any binary source such as a digital input or fieldbus control word (parameter [19.11 Ext1/Ext2 selection](#)). The source of reference is selectable for each operating mode separately.

Communication fail functionality

The communication fail functionality ensures continuous process without interruptions. If there is a communication loss, the drive automatically changes the control location from EXT1 to EXT2. This enables process to be controlled, for example, with the drive PID controller. When the original control location recovers, the drive automatically switches control back to the communication network (EXT1).

Settings

- Parameters [19.11 Ext1/Ext2 selection](#) (page 341); [20.01 Ext1 commands...](#)[20.09 Ext2 in2 source](#) (page 342).

Operating modes of the drive

The drive can operate in several operating modes with different types of reference. The mode is selectable for each control location (Local, EXT1 and EXT2) in parameter group [19 Operation mode](#). An overview of the different reference types and control chains is shown below.

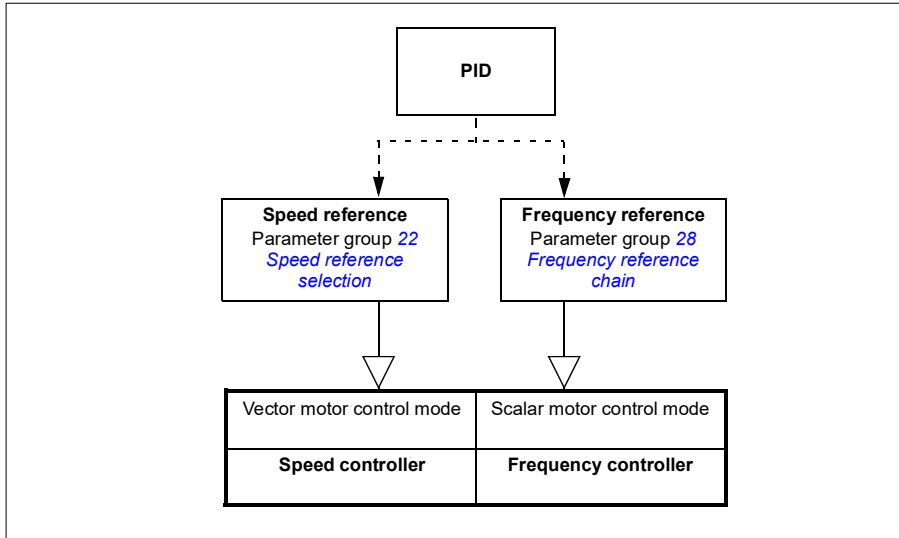

Drive configuration and programming

The drive control program performs the main control functions, including speed and frequency control, drive logic (start/stop), I/O, feedback, communication and protection functions. Control program functions are configured and programmed with parameters.

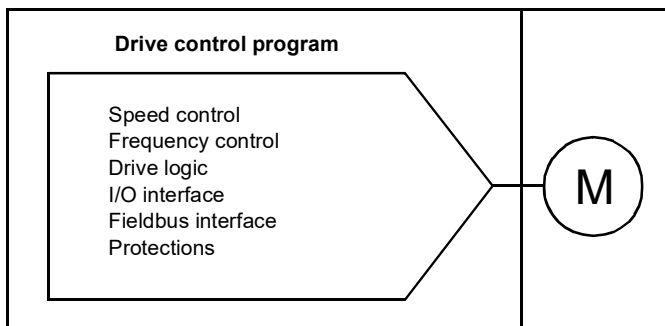

■ Configuring via default configurations

Default configurations are predefined I/O configurations. See chapter [Default I/O configuration](#) (page 83).

■ Configuring via menus

The drive can be configured using the **Primary settings** and other menus on the control panel. They effectively change parameters but they guide you with assistants, and you do not have to know the parameter names and numbers. See chapter [Settings, I/O and diagnostics on the control panel](#) (page 45).

■ Configuring via parameters

Parameters configure all of the standard drive operations and can be set via

- the control panel, as described in chapter [Control panel](#) (see page 35)
- the Drive composer PC tool, as described in *Drive composer user's manual* (3AUA0000094606 [English]), or
- the fieldbus interface, as described in chapters [Fieldbus control through the embedded fieldbus interface \(EFB\)](#) (see page 223) and [Fieldbus control through a fieldbus adapter](#) (see page 253).

All parameter settings are stored automatically to the permanent memory of the drive. However, if an external +24 V DC power supply is used for the drive control unit, it is highly recommended to force a save by using parameter [96.07 Parameter save manually](#) before powering down the control unit after any parameter changes have been made.

If necessary, the default parameter values can be restored by parameter [96.06 Parameter restore](#).

■ Adaptive programming

Conventionally, the user can control the operation of the drive by parameters. However, the standard parameters have a fixed set of choices or a setting range. To further customize the operation of the drive, an adaptive program can be constructed out of a set of function blocks.

The Drive composer PC tool (available separately) has an Adaptive programming feature with a graphical user interface for building the custom program. The function blocks include the usual arithmetic and logical functions, as well as, for example, selection, comparison and timer blocks.

The physical inputs, drive status information, actual values, constants and parameters can be used as the input for the program. The output of the program can be used, for example, as a start signal, external event or reference, or connected to the drive outputs. See the table below for a listing of the available inputs and outputs.

6

If you connect the output of the adaptive program to a selection parameter that is a pointer parameter, the selection parameter will be write-protected.

Example:

If parameter [31.01 External event 1 source](#) is connected to an adaptive programming block output, the parameter value is shown as Adaptive program on a control panel or PC tool. The parameter is write-protected (= the selection cannot be changed).

The status of the adaptive program is shown by parameter [07.30 Adaptive program status](#). The adaptive program can be disabled by [96.70 Disable adaptive program](#).

For more information, see the *Adaptive programming application guide* (3AXD50000028574 [English]).

Inputs available to the adaptive program	
Input	Source
I/O	
DI1	10.02 DI delayed status , bit 0
DI2	10.02 DI delayed status , bit 1
DI3	10.02 DI delayed status , bit 2
DI4	10.02 DI delayed status , bit 3
DI5	10.02 DI delayed status , bit 4
DI6	10.02 DI delayed status , bit 5
AI1	12.11 AI1 actual value
AI2	12.21 AI2 actual value
<i>Actual signals</i>	
Motor speed	01.01 Motor speed used
Output frequency	01.06 Output frequency
Motor current	01.07 Motor current
Motor torque	01.10 Motor torque
Motor shaft power	01.17 Motor shaft power

Inputs available to the adaptive program	
<i>Input</i>	<i>Source</i>
<i>Status</i>	
Enabled	06.16 Drive status word 1, bit 0
Inhibited	06.16 Drive status word 1, bit 1
Ready to start	06.16 Drive status word 1, bit 3
Tripped	06.11 Main status word, bit 3
At setpoint	06.11 Main status word, bit 8
Limiting	06.16 Drive status word 1, bit 7
Ext1 active	06.16 Drive status word 1, bit 10
Ext2 active	06.16 Drive status word 1, bit 11
<i>Data storage</i>	
Data storage 1 real32	47.01 Data storage 1 real32
Data storage 2 real32	47.02 Data storage 2 real32
Data storage 3 real32	47.03 Data storage 3 real32
Data storage 4 real32	47.04 Data storage 4 real32

Outputs available to the adaptive program	
<i>Output</i>	<i>Target</i>
<i>I/O</i>	
RO1	10.24 RO1 source
RO2	10.27 RO2 source
RO3	10.30 RO3 source
AO1	13.12 AO1 source
AO2	13.22 AO2 source
<i>Start control</i>	
Ext1/Ext2 selection	19.11 Ext1/Ext2 selection
Ext1 in1 cmd	20.03 Ext1 in1 source
Ext1 in2 cmd	20.04 Ext1 in2 source
Ext2 in1 cmd	20.08 Ext2 in1 source
Ext2 in2 cmd	20.09 Ext2 in2 source
Fault reset	31.11 Fault reset selection
<i>Speed control</i>	
Ext1 speed reference	22.11 Ext1 speed ref1
Speed proportional gain	25.02 Speed proportional gain
Speed integration time	25.03 Speed integration time
Acceleration time 1	23.12 Acceleration time 1
Deceleration time 1	23.13 Deceleration time 1
<i>Frequency control</i>	
Ext1 frequency reference	28.11 Ext1 frequency ref1
<i>Events</i>	
External event 1	31.01 External event 1 source
External event 2	31.03 External event 2 source
External event 3	31.05 External event 3 source
External event 4	31.07 External event 4 source
External event 5	31.09 External event 5 source
<i>Data Storage</i>	
Data storage 1 real32	47.01 Data storage 1 real32
Data storage 2 real32	47.02 Data storage 2 real32
Data storage 3 real32	47.03 Data storage 3 real32

Outputs available to the adaptive program	
Output	Target
Data storage 4 real32	47.04 Data storage 4 real32
<i>Process PID</i>	
Set 1 setpoint 1	40.16 Set 1 setpoint 1 source
Set 1 setpoint 2	40.17 Set 1 setpoint 2 source
Set 1 feedback 1	40.08 Set 1 feedback 1 source
Set 1 feedback 2	40.09 Set 1 feedback 2 source
Set 1 gain	40.32 Set 1 gain
Set 1 integration time	40.33 Set 1 integration time
Set 1 tracking mode	40.49 Set 1 tracking mode
Set 1 track reference	40.50 Set 1 tracking ref selection

Adaptive program fault and aux code formats

The format of the aux code:

Bits 24-31: State number	Bits 16-23: block number	Bits 0-15: error code
--------------------------	--------------------------	-----------------------

If the state number is zero but the block number has a value, the fault is related to a function block in the base program. If both state number and block number are zero, the fault is a generic fault that is not related to a specific block.

6

See fault [64A6 Adaptive program](#) on page [209](#).

Sequence program

An adaptive program can contain base program and sequence program parts. Base program is run continuously when adaptive program is in running mode. The functionality of the base program is programmed using function blocks and system inputs and outputs.

Sequence program is a state machine. This means that only one state of the sequence program is run at a time. You can create a sequence program by adding states and programming the state programs using the same program elements as in the base program. You can program state transitions by adding state transition outputs to the state programs. The state transition function rules are programmed using function blocks.

The number of the active state of the sequence program is shown by parameter [07.31 AP sequence state](#).

Control interfaces

■ Programmable analog inputs

The control unit has two programmable analog inputs. Each of the inputs can be independently set as a voltage (0/2...10 V) or current (0/4...20 mA) input with parameters. Each input can be filtered, inverted and scaled.

Settings

- Parameter group [12 Standard AI](#) (page [320](#)).

■ Programmable analog outputs

The control unit has two current (0...20 mA) analog outputs. Analog output 1 can be set as a voltage (0/2...10 V) or current (0/4...20 mA) output with a parameter. Analog output 2 always uses current. Each output can be filtered, inverted and scaled.

Settings

- Parameter group [13 Standard AO](#) (page [325](#)).

■ Programmable digital inputs and outputs

The control unit has six digital inputs.

Digital input DI5 can be used as a frequency input.

Digital input DI6 can be used as a thermistor input.

Six digital inputs can be added by using a CHDI-01 115/230 V digital input extension module and one digital output by using a CMOD-01 multifunction extension module.

Settings

- Parameter groups [10 Standard DI, RO](#) (page [309](#)) and [11 Standard DIO, FI, FO](#) (page [319](#)).

■ Programmable frequency input and output

Digital input DI5 can be configured as a frequency input.

A frequency output can be implemented with a CMOD-01 multifunction extension module.

Settings

- Parameter groups [10 Standard DI, RO](#) (page [309](#)) and [11 Standard DIO, FI, FO](#) (page [319](#)).

■ Programmable relay outputs

The control unit has three relay outputs. The signal to be indicated by the outputs can be selected by parameters.

Two relay outputs can be added by using a CMOD-01 multifunction extension module or a CHDI-01 115/230 V digital input extension module.

Settings

- Parameter group [10 Standard DI, RO](#) (page 309).

■ Programmable I/O extensions

Inputs and outputs can be added by using a CMOD-01 or CMOD-02 multifunction extension module or a CHDI-01 115/230 V digital input extension module. The module is mounted on option slot 2 of the control unit.

The table below shows the number of I/O on the control unit as well as optional CMOD-01, CMOD-02 and a CHDI-01 modules.

Location	Digital inputs (DI)	Digital outputs (DO)	Analog inputs (AI)	Analog outputs (AO)	Relay outputs (RO)
Control unit	6	-	2	2	3
CMOD-01	-	1	-	-	2
CMOD-02	-	-	-	-	1 (non-configurable)
CHDI-01	6 (115/230 V)	-	-	-	2

The I/O extension module can be activated and configured using parameter group 15.

The CMOD-02 offers, in addition to the relay output (non-configurable), a +24VDC/AC input and a thermistor input.

Note: The configuration parameter group contains parameters that display the values of the inputs on the extension module. These parameters are the only way of utilizing the inputs on an I/O extension module as signal sources. To connect to an input, choose the setting *Other* in the source selector parameter, then specify the appropriate value parameter (and bit, for digital signals) in group 15.

Note: With the CHDI, you can use up to six additional digital inputs. The CHDI does in no way affect the fixed digital inputs on the control board.

Settings

- Parameter group [15 I/O extension module](#) (page 331).

■ Fieldbus control

The drive can be connected to several different automation systems through its fieldbus interfaces. See chapters [Fieldbus control through the embedded fieldbus interface \(EFB\)](#) (page 223) and [Fieldbus control through a fieldbus adapter](#) (page 253).

Settings

- Parameter groups [50 Fieldbus adapter \(FBA\)](#) (page 467), [51 FBA A settings](#) (page 471), [52 FBA A data in](#) (page 473), and [53 FBA A data out](#) (page 473) and [58 Embedded fieldbus](#) (page 474).

■ Control of a line supply unit (LSU)

Overview

This feature is only supported for ACQ580-31 and ACQ580-34 drives.

ACQ580-31 and ACQ580-34 drives consist of one line supply unit (LSU) and one inverter unit (INU). The control units of the supply unit and the inverter unit are connected by an internal communication bus.

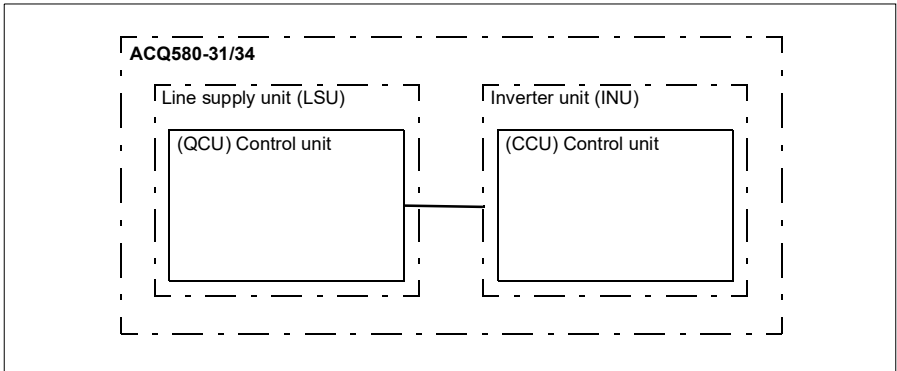

The supply unit can be controlled through the inverter unit. For example, the inverter unit can send a control word and references to the supply unit, enabling the control of both units from the interfaces of one control program.

It is possible to send a DC voltage and/or reactive power reference to the supply unit (if there is enough capacity) from the inverter parameter group [94 LSU control](#). A supply unit sends actual signals to the inverter unit which are visible in parameter group [01 Actual values](#).

Settings

- Parameters in groups:
 - [01 Actual values](#) (page 288): [01.102...01.164](#)
 - [05 Diagnostics](#) (page 295): [05.111...05.121](#)
 - [06 Control and status words](#) (page 298): [06.36...06.39](#), [06.116...06.118](#)
 - [07 System info](#) (page 307): [07.106...07.107](#)
 - [30 Limits](#) (page 384): [30.101...30.149](#)
 - [31 Fault functions](#) (page 392): [31.120...31.121](#)
 - [96 System](#) (page 516): [96.108 LSU control board boot](#).
- Parameter groups [60 DDCS communication](#) (page 481), [61 D2D and DDCS transmit data](#) (page 481) and [62 D2D and DDCS receive data](#) (page 482).

Pump control features

Note: ABB recommends reading the pump manufacturer's instructions for optimal performance.

■ Intelligent pump control (IPC)

Multipump/fan systems consist of several pumps or fans, each connected to a separate drive. This arrangement enables a high flexibility in load sharing, balancing the run time between the pumps or fans and keeping each pump or fan running optimally. If the active pumps or fans cannot meet the demand, the system automatically starts pumps or fans one by one. Similarly, if the demand decreases, the system automatically stops pumps or fans one by one in order to keep the remaining pumps or fans running at optimal efficiency.

The IPC system at first increases the first, or lead, pump's speed. If this is not sufficient, the IPC will start lag pump(s) in sequence to meet the process demand. While starting a new pump, the speed of the already running pumps is reduced to allow smooth flow of liquid.

The order of the pumps or fans used can be defined to balance the run time better (pumps or fans that have run the least, start first) or can be set by the efficiency class of each pump or fan (for example, pumps or fans with high efficiency are primarily used).

Note: Node numbers of the drives must be sequential starting from 1.

Multipump/fan systems achieve high levels of up-time and reliability, if one pump or fan fails or requires maintenance, other pumps or fans can take over the operation. Efficiency, continuous operation and easy maintenance are reasons why multipump/fan systems can be found in a variety of different applications in the HVAC and W/WW industries.

In the IPC system one drive at a time acts as a master and you can use up to seven follower drives. With a moving master strategy each of the drives in the team can be selected to be eligible as master. The master drive controls the whole multi-pump-system and has the following tasks:

- activating and deactivating the follower drives
- regulating the systems speed with its internal PID loop control according to an internal set-point
- processing the I/O signals (set-point and feedback signals).

The IPC system can be enabled using primary settings or parameter [76.21 Multipump configuration](#).

In an IPC system, the drives communicates through inverter-to-inverter link on embedded fieldbus. Each drive in the system requires a run command for the IPC logic to function and use the drive if needed. By default in Auto mode this is done by using DI1. Note that settings for setpoint and actual value are not copied through the

inverter-to-inverter link. These signals must be externally sent to each drive to ensure a redundant system.

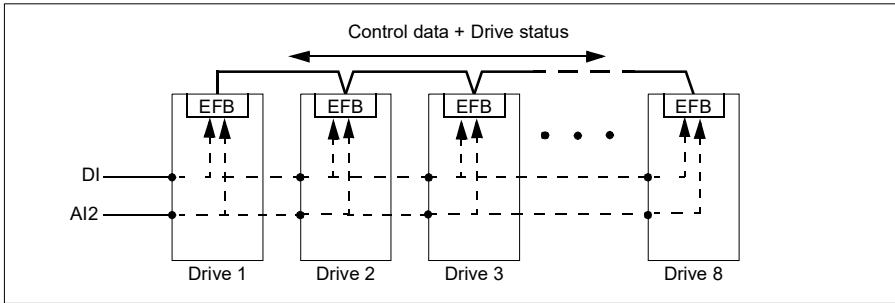

Starting the IPC system

The IPC system starts operation when the drive receives a start command from external control location EXT2 (parameter [20.08 Ext2 in1 source](#)). The start command indicates that the pump is available to the IPC system. However, the system sends the actual start command to the follower drives based on the required output of the system.

6

If all drives in the system receive a start command simultaneously, then, by default, the drive with the least run time and that is ready to run, will start as the master drive. See parameter [76.22 Multipump node number](#) (page 488). For optimal energy operation, you can combine the PID sleep function with IPC system. For information on PID sleep function, see [Sleep and boost functions for process PID control](#) (page 137).

Note: The IPC system is not active on external control location EXT1.

Smooth pump transitions

The figure below shows the smooth pump transitions with different ramp times.

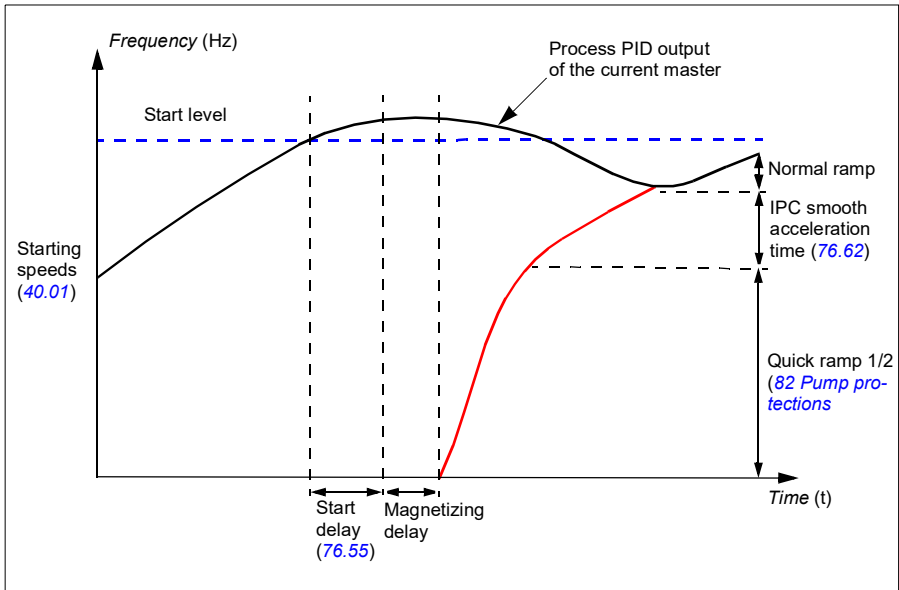

The timing diagram of smooth pump transitions shows the pump starting steps. In this case, the process PID output of the current master has exceeded the start level (76.30...76.36).

1. The IPC system starts a new pump after the start delay time (76.55 Start delay) is elapsed.
2. After the motor is magnetized and starts rotating, the new pump accelerates using quick ramp 1 and 2 to reach productive zone (see section *Ramps – Quick ramps* on page 128).

Note: This operation is effective only when quick ramp mode is enabled with parameter 82.01 *Quick ramp accel. mode*.

The new pump then accelerates to the master speed along IPC smooth ramp time defined with parameter 76.62 *IPC smooth acceleration time*.

3. When a new pump is accelerating, the other pumps decelerate to maintain the stable output of the system, shown as Normal ramp in the diagram.
4. After the new pump reaches the speed of the current master pump, the new pump becomes the new master.
5. The new master and all the remaining pumps will start to follow the master drive speed defined by the process PID of the master drive.

Pump priorities

The pumps are prioritized based on energy efficiency and process demand.

- **High** – more energy efficient pumps
- **Normal** – less energy efficient pumps
- **Low** – pumps which do not run unless process demands

You can select the pump priority with parameter [76.77 Pump priority](#). The IPC system prefers high priority pumps over normal and low priority pumps. You can limit the time a pump is not run with parameter [76.76 Max stationary time](#), so that even the low priority pumps are exercised often enough to keep them in operational condition. Pressure-maintenance pumps (Jockey pumps) should be controlled separately to provide the necessary control.

Master-follower change principle

1. The master controls the process until the follower has reached the setpoint. There is no master follower change if the setpoint is not achieved.
- 6
1. This allows, for example, the pump cleaning function for the follower pump at start-up without confusing the system.
 2. Max stationary time is followed (if that is set).
This has high priority because it makes sure the pump is kept in good condition and it just does not stay inoperative.
 3. After checking the max stationary time, the pump priorities are followed.
This makes sure the pumps with high priority are operated the most often.
 4. If none of the above conditions are set, the system tries to balance the operation time between all the pumps.

Automatic parameter synchronization

Automatic parameter synchronization feature reduces the number of configuration steps in the IPC system.

The synchronized parameter groups are selected with parameter [76.102 IPC synchronization settings](#). In addition, there are some drive dependent parameters that are not synchronized, like [76.22 Multipump node number](#). To enable synchronization of a parameter group between two or more drives, the group synchronization must be enabled in all the drives.

The synchronization process uses two mechanisms to make sure that the parameter groups are synchronized. When a parameter value is changed in a drive, it broadcasts the changed parameter value to inverter-to-inverter (I2I) link. From the inverter-to-inverter (I2I) link, all the drives that have the synchronization enabled, reads the value and set their own parameter value.

In addition, the drive periodically broadcast the group **CRC** (cyclic redundancy check) to the inverter-to-inverter (I2I) link along with the time stamp of the last edit time of the group. From this information, the drives can conclude if the group is synchronized and which drive has the latest parameter values. If there is a **CRC** mismatch, the drives request the parameter values from the parameter group and from the drive with the latest values.

You can monitor changes in the drive configuration with Parameter checksum calculation, see section [Parameter checksum calculation](#) on page 183.

■ IPC master autochange

An IPC system consists of several pumps (drives) but has only one active master pump. The master pump controls the IPC system by starting and stopping the follower pumps when necessary, and by sending the reference to all follower pumps over the IPC network.

Usually the pump that was started first is the first active master. If multiple drives are started at the same time, the pump with the smallest node number will be the active master. The autochange feature is used to transfer this master status on the IPC system to the next pump in the specified sequence. This way the autochange will also affect the start order of the follower pumps.

Note: Node numbers of the drives must be sequential starting from 1.

Autochange can be triggered in several ways. The trigger is selected with parameter [76.70 PFC Autochange](#). These triggers include digital inputs, timed functions, fixed intervals of time, when all pumps are stopped or whenever wear logic determines it is time to change the master. Even when this trigger is active, PID feedback must be at the set point and pump speed must be below parameter [76.73 Autochange level](#) before autochange can occur.

If autochange is not possible because of the above reasons, the system will remember the request and will perform autochange when all the requirements have been fulfilled.

Autochange can be done using two possible sequences: either with even wear or fixed sequence.

For IPC, the default value for parameter [76.70 PFC Autochange](#) is *Even wear*. If the parameter value is *Not selected* or *Selected*, the system will automatically select *Even wear*.

If the [76.70 PFC Autochange](#) value is other than *Not selected*, *Selected* or *Even wear*, the fixed sequence will be used. The fixed interval time can be specified with parameter [76.71 PFC Autochange interval](#).

Even wear is the default value after selecting IPC configuration. With even wear, the master status is transferred to a follower pump fulfilling the necessary requirements. These requirements include (from the highest to the lowest priority):

- maximum stationary time (parameter [76.76](#))
- pump priority (parameter [76.77](#))
- maximum wear imbalance (parameter [76.72](#))
- run time (parameters [77.10...77.18](#))
- node number (parameter [76.22](#)).

Fixed sequence transfers the master status to the next node number. For example, if pump 1 is the master and the start order is 1-2-3-4, then after autochange pump 2 will be the master and the start order becomes 2-3-4-1. If the next master pump is not running when autochange is triggered, it will be started and master status will be transferred to that pump when it has completed start up ramping.

Note that fixed sequence autochange requires that one pump can be started or that all pumps (the number of pumps equals the maximum pump count) are running before autochange can be done. For example, if you have 8 pumps and the maximum has been set to 3, and 3 pumps are running, autochange will not occur until the third pump is stopped, because otherwise the start order would not be correct (it is not possible to exceed the maximum number of pumps). However, in this example, if the maximum has been set to 8 and all 8 pumps are running, autochange will occur.

If you do not want some specific pump to be a master (for example if the pump does not have process feedback connected), set parameter [76.23 Master enable](#) for that pump to *False*. This way the pump will be bypassed when transferring master status during the autochange.

The master enable parameter can also be connected to other bit sources, for example supervision, to prevent the pump from being a master after some event has occurred (if for example AI was broken).

If the running master loses its ability to be the master, the system tries to recover from this as fast as possible by selecting the new master and starting new pumps if needed.

The IPC system communicates via the I2I bus connected to EFB by sending reference, status, run time and other system information between the pumps. If there is a communication loss between pumps when using fixed sequence, the pump with the lowest node number becomes the new master for a network segment that did not yet have an active master. With even wear, the next master selection is based on the even wear logic. When pumps can again communicate with each other, the master pump with the lowest node number remains the master while the active master from the other network segment releases the master status after some delay.

If a pump does not see any other pumps, it will wait for the time defined in parameter [40.33 Set 1 integration time](#) before it starts pumping. If the system is at setpoint when

the time has passed, the single pump will not start in order to not interfere with the system.

Pump cleaning and autochange

Pump cleaning can affect the autochange functionality. If the next master in sequence is performing pump cleaning when autochange is triggered, it will be bypassed and the next pump after it becomes the active master.

Also, the master does not stop a pump that is performing pump cleaning during autochange, but waits until pump cleaning has finished. If the active master is triggered to start pump cleaning, it does the autochange automatically. If the next master pump is configured to trigger pump cleaning at every start and autochange is triggered when that pump is not running, the currently active master will wait until pump cleaning has been completed before the master status is changed.

Settings

- Parameter group [76 Multipump configuration](#) (page 484)
- Parameter group [77 Multipump maintenance and monitoring](#) (page 497).

Application example: IPC system with three drives and three pumps

In this example three drives with three pumps are connected to work in cooperation. The example simulates how the pressure sensor controls the system. The external pressure sensor needs to be connected to the system and it will send the information to the drive, which controls the operation of the pump as well as the follower drives.

The individual pumps can be tested in Hand mode (local control) which gives the ability to set the speed from the control panel. The drives can be started and stopped via Hand and Off buttons on the control panel.

To operate the IPC system, the system needs to be operated in Auto mode (remote control) and with PID closed loop control. PID setpoint is set as constant setpoint and the pressure transmitter used as process feedback is wired to analog input 2.

To start the system, the following digital inputs are used: DI1 Enable start of the system (Start / Stop) and DI2 Run Permission (dry pump sensor connection).

Notes:

- If any run permissive or interlock is not satisfied (see parameters [20.40 Run permissive ... 20.44 Start interlock 4](#)) the drive will not be allowed to run.
- IPC system requires that all the drives are programmed with same firmware version. Different firmware version generates an IPC version error fault because internal checksum will have mismatch.

6

Wiring diagram

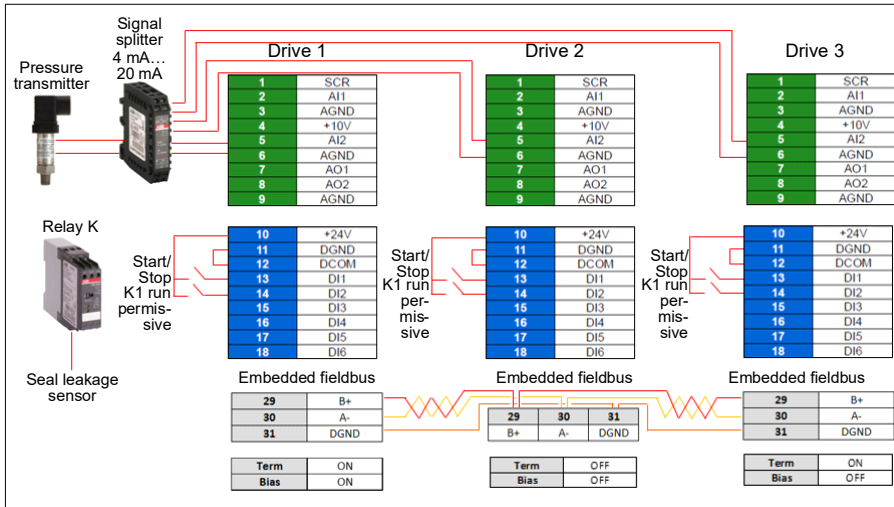

Note: If a current signal is used, use a signal splitter to connect the sensor signal to all drives that may take on the master role.

Voltage signal can also be used for sensor feedback. This allows chaining the sensor signal. The distance should be a consideration on the signal type.

Quick steps – Programming summary

Start up all three drives normally (see section [How to start up the drive](#) on page 22).

Configure IPC in the first drive

By setting up the first drive you can replicate the drive parameters using the synchronization feature under [Select Shared settings](#) below. This speeds up the commissioning process and helps to avoid mistakes.

Menu > Primary settings > Pump features

- Select **Multipump control**
- Select and edit **Pumping mode: *Intelligent pump control (IPC)***
- Press **Next**
 - Edit **Node number**: (This number must be unique for each drive in the IPC system. In this example, we are using 1 for the first drive, 2 for the second drive and 3 for the third drive.)
 - Press **Next**
- Select **Settings for this pump**
 - Edit **Drive name**: (Keep the default name or give a unique name.)
 - Edit **Node number**: (Enter Node number if not already given above.)
 - Select **Can be master**. (In this example all three drives can act as a master. Redundant operation requires moving master. If this is not selected, the drive can only operate as a follower.)
 - Edit **Prefer this pump: *Medium***. (The pumps can be prioritized based on energy efficiency and process demand: High - more energy efficient pumps, Medium - less energy efficient pumps, Low - pumps which do not run unless process demands. Similar pumps are recommended to be used in booster applications.)
 - Press **Back**
- Select **Shared settings**
 - Select **Synchronization settings**
 - Edit **Do you want to allow synchronization of settings with other drives?**: Yes. (Synchronization will save significant amount of time for the total system configuration. It also ensures that values within selected parameter groups are equal and copied according to last changed parameter.)
 - Press **Next**
 - Edit **Select settings to copy between all drives**:
 - Select **AI settings**
 - Select **PID settings**
 - Select **IPC shared settings**

- Press **Next**
- Edit **Total number of pumps: 3**
- Edit **Always run at least: 1 pump**
- Edit **Never more than: 3 pumps** (These three pieces of information are synchronized over the inverter-to-inverter link between all drives.)
- Select **Start/stop speeds** (Define when a pump should be started or stopped by the system in order to meet the demand, keeping the target pressure.
Example values:
 - Edit **Start 2nd pump at: 48 Hz**
 - Edit **Start 3rd pump at: 48 Hz**
 - Edit **Stop 3rd pump at: 25 Hz**
 - Edit **Stop 2nd pump at: 25 Hz**

If the first pump cannot keep the pressure and exceeds 48 Hz, the second pump will be activated. If the demand is still rising and both pumps exceed 48 Hz the third pump will be activated.

If the demand declines and the three activated pumps fall under 25 Hz, the third pump will be deactivated. If the demand is still too low and the remaining two pumps fall below 25 Hz, the second pump will be deactivated.

These values **must** be defined according to the system. In many applications the start and stop speeds fall in narrow ranges, for example, 25...30 Hz and 40...45 Hz.

- Press **Back**
- Select **Transition smoothing**
 - Edit **Ignore demand spikes under: 2.00 s** (The spike time describes how long the output frequency needs to exceed the start point Hz setting, in this case, 48 Hz until the IPC starts the next drive.)
 - Edit **Ignore demand dips under: 3.00 s** (The dip time describes how long the frequency needs to stay below 25 Hz until the IPC stops one drive. This smooths the IPC behavior and avoids unnecessary starts and stops of the drives.)
 - Press **Back**
- Select **Autochange**. This function ensures, that the run time of all drives in the system is balanced.
 - Edit **Maximum wear imbalance: 12 h**. (This specifies the maximum difference in the running time between the drives in an IPC system.)
 - Edit **Maximum stationary time: 0.0 h**. (This makes sure the pump get exercised frequently. This protects especially low prioritized pump from pump blockages. Value 0.0 h disables the parameter.)

- Edit **Autochange only below**: *100%*. (This specifies the maximum speed when pump change is allowed. Value 100% allows a pump change action whenever it is needed.)
- Press **Back**
- Select **PID control (Secondary reference, EXT2)**
- Select **Use PID control**
- Edit **Activate PID control from**: *Always active*
- Edit **Start/stop/dir from**: *DI Start/stop*
- Edit **Unit**: *bar*
- View **PID status**: *0 hex*
- Select **Feedback**
 - **Actual value**: *0.0 bar*
 - Edit **Source**: *AI2 scaled*
 - Select **AI2 scaling**
 - Edit **Range**: *4...20 mA*
 - Edit **Scaled min**: *0.000 bar*
 - Edit **Scaled max**: *6.000 bar*
 - Press **Back**
 - Edit **filter time**: *0.000 s*
 - Press **Back**
- Select **Setpoint**
 - **Actual value**: *0.0 bar*
 - Edit **Source**: *Constant setpoint*
- Select **Constant setpoints**
 - Edit **Constant setpoint 1**: *4.00 bar*
 - Edit **Constant setpoint 2**: *0.00 bar*
 - Edit **Minimum**: *0.00 bar*
 - Edit **Maximum**: *6.00 bar*
 - Press **Back**
- Select **Tuning**
 - **Deviation actual value**: *0.00 bar*
 - Edit **Gain**: *1.00*
 - Edit **Derivation time**: *0.000 s*
 - Edit **Derivation filter time**: *0.0 s*
 - Press **Back**
- Edit **Increase output**: *Feedback < Setpoint* (Used when filling booster pump or tank. "Feedback > Setpoint" is used, for example, when emptying a tank.)

- Select **Output**:
 - **Actual value**: 0.00
 - Edit **Minimum**: 0.00
 - Edit **Maximum**: 50.00 (US:60.00) (Hz) or 100.0 (%)
 - Press **Back**
- Select and edit **Sleep function**: Off
- Press **Back** repeatedly to get to **Primary settings**.

Configure the rest of the drives

After starting up and configuring IPC of the first drive in the system, you can then start-up the rest of the drives (see section [How to start up the drive](#) on page 22).

Then configure each of these drive as follows.

Menu > Primary settings > Pump features

- Select **Multipump control**
- Select **Pumping mode**: *Intelligent pump control (IPC)*
- Press **Next**
 - Edit **Node number**: (The rest of the drives, in this example 2...3.)
 - Press **Next**
- Select **Communication link source**
 - Select EFB or FBA
 - Press **Next**
- Select **Settings for this pump**
 - Edit **Drive name**: (Give a unique name.)
 - Edit **Node number**: (Enter Node number if not already given above.)
 - Select **Can be master**
 - Edit **Prefer this pump**: *Medium*
 - Press **Back**
- Select **Shared settings**
 - Select **Synchronization settings**
 - Edit Do you want to allow synchronization of settings with other drives?: Yes.
 - Press **Next**
 - Edit **Select settings to copy between all drives**:
 - Select **AI settings**
 - Select **PID settings**
 - Select **IPC shared settings**
 - Press **Back** repeatedly to get to **Primary settings**.

Now all the above parameter settings are copied to this drive and the system is ready to run.

Settings

- **Menu > Primary settings > Multipump Control (IPC)**
- Parameter group [01 Actual values](#) (page 288)
- Parameter group [40 Process PID set 1](#) (page 437)
- Parameter groups [76 Multipump configuration](#) (page 484) and [77 Multipump maintenance and monitoring](#) (page 497).

■ Single pump control (PFC/SPFC)

The Single pump control (PFC) is used in pump systems consisting of one drive and multiple pumps. The drive controls the speed of one of the pumps and in addition connects (and disconnects) the other pumps directly to the supply network through contactors.

6 The PFC control logic switches auxiliary motors on and off as required by the capacity changes of the process. In a pump application, for example, the drive controls the motor of the first pump, varying the motor speed to control the output of the pump. This pump is the speed regulated pump. When the demand (represented by the process PID reference) exceeds the capacity of the first pump (a user defined speed/frequency limit), the PFC logic automatically starts an auxiliary pump. The logic also reduces the speed of the first pump, controlled by the drive, to account for the addition to the total system output by the auxiliary pump. Then, as before, the PID controller adjusts the speed/frequency of the first pump in such a way that the system output meets the process needs. If the demand continues to increase, the PFC logic adds further auxiliary pumps, in a similar manner as just described.

As the demand drops, making the speed of the first pump fall below a minimum limit (user defined as a speed/frequency limit), the PFC logic automatically stops an auxiliary pump. The PFC logic also increases the speed of the drive controlled pump to account for the missing output of the stopped auxiliary pump.

The Single pump control (PFC) is supported in external control location EXT2 only.

Example: Three-pump constant pressure water supply application

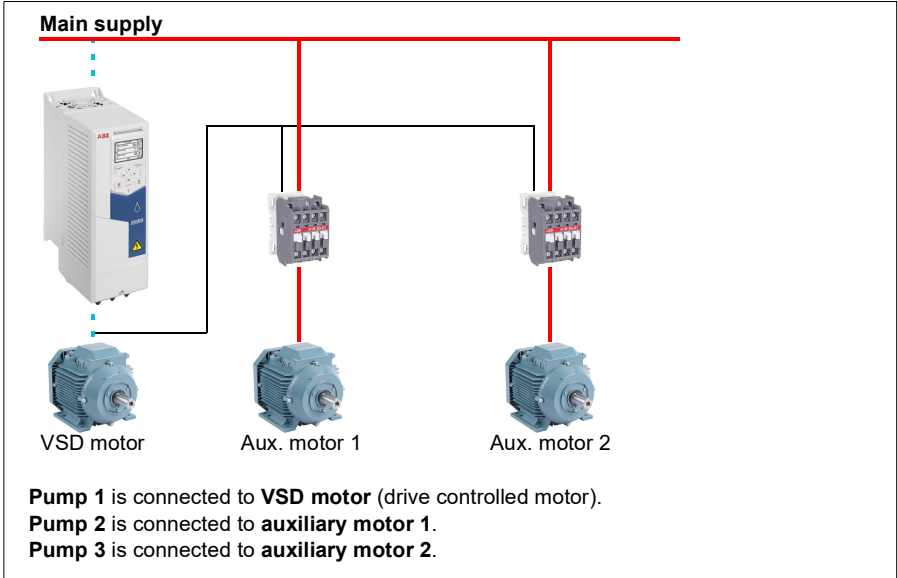

6

Flow consumption vs. pump status			
Consumption	Pump 1	Pump 2	Pump 3
Low	VSD	Off	Off
↓	VSD	DOL	Off
High	VSD	DOL	DOL
↓	VSD	DOL	Off
Low	VSD	Off	Off

VSD = Controlled by drive, tuning the output speed according to PID control.

DOL = Direct On Line. Pump is running at fixed motor nominal speed.

Off = Off-line. Pump stops.

Soft pump control (SPFC)

The Soft pump control (SPFC) logic is a variant of the PFC logic for pump and alternation applications where lower pressure peaks are desirable when a new auxiliary motor is to be started. The SPFC logic is an easy way to implement soft starting of direct on line (auxiliary) motors.

The main difference between traditional PFC and SPFC logic is how the SPFC logic connects auxiliary motors on-line. When the criteria for starting a new motor is fulfilled (see above) the SPFC logic disconnects the drive controlled motor from the drive and immediately connects that motor to the supply network in a flying start, that is, while the motor is still coasting. The drive then connects to the next pump unit to be started

and starts controlling the speed of that one, while the previously controlled unit is now connected directly on line through a contactor.

Further (auxiliary) motors are started in a similar manner. The motor stopping routine is the same as for the normal PFC routine.

In some cases SPFC makes it possible to soften the start-up current while connecting auxiliary motors on-line. Lower pressure peaks on the pipelines and pumps may be achieved as a result.

Example: Three-pump constant pressure water supply application

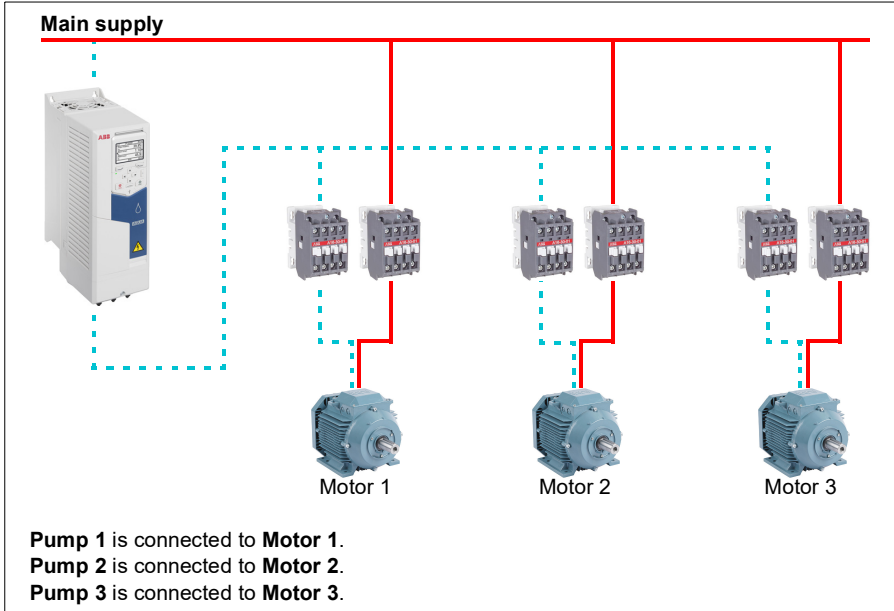

Flow consumption and pump status			
Consumption	Pump 1	Pump 2	Pump 3
Low	VSD	Off	Off
↓	DOL	VSD	Off
High	DOL	DOL	VSD
↓	DOL	Off	VSD
Low	Off	Off	VSD
↓	VSD	Off	DOL
High	DOL	VSD	DOL
↓	DOL	VSD	Off
Low	Off	VSD	Off
↓	VSD	DOL	Off
High	DOL	DOL	VSD

VSD = Controlled by drive, tuning the output speed according to PID control.

DOL = Direct On Line. Pump is running at fixed motor nominal speed.

Off = Off-line. Pump stops.

Autochange

Automatic rotation of the start order, or Autochange functionality, serves two main purposes in many PFC type setups. One is to keep the run times of the pumps equal over time to even their wear. The other is to prevent any pump from standing still for too long, which would clog up the unit. In some cases it is desirable to rotate the start order only when all units are stopped, for example, to minimize the impact on the process.

The Autochange can also be triggered by the Timed function (see page 133).

There are three modes of autochange according to what kind of PFC and SPFC together with auxiliary circuit are implemented.

1. Autochange PFC with auxiliary motors only

Example: Three-pump constant pressure water supply application.

Two pumps fulfill the flow consumption for long term running, and the third pump is reserved for shifting. In this mode, only two auxiliary motors, pump 2 and pump 3, shift working.

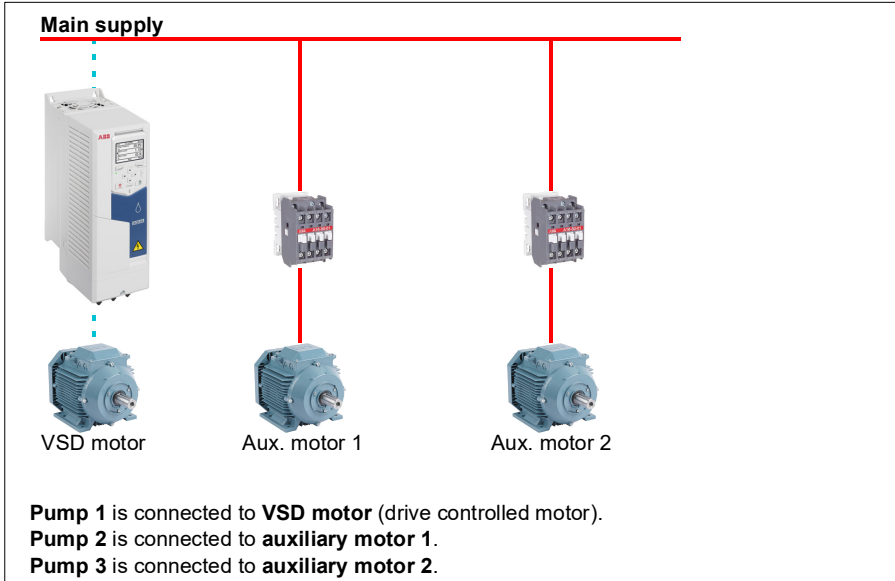

6

Flow consumption and pump status			
Consumption	Pump 1	Pump 2	Pump 3
Low	VSD	Off	Off
Normal	VSD	DOL	Off
↓	VSD	Off	DOL
↓	VSD	DOL	Off
Normal	VSD	Off	DOL

VSD = Controlled by drive, tuning the output speed according to PID control.

DOL = Direct On Line. Pump is running at fixed motor nominal speed.

Off = Off-line. Pump stops.

2. Autochange PFC with all motors

Example: Three-pump constant pressure water supply application

Two pumps fulfill the flow consumption for long term running, and the third pump is reserved for shifting. Because all motors will be shifted for autochange routine, special auxiliary circuit is needed, which is the same as for the SPFC system.

In this mode, the VSD motor will move to the next pump one by one, but the auxiliary motor will always be put on-line in DOL mode. However, three pumps are shifted overall.

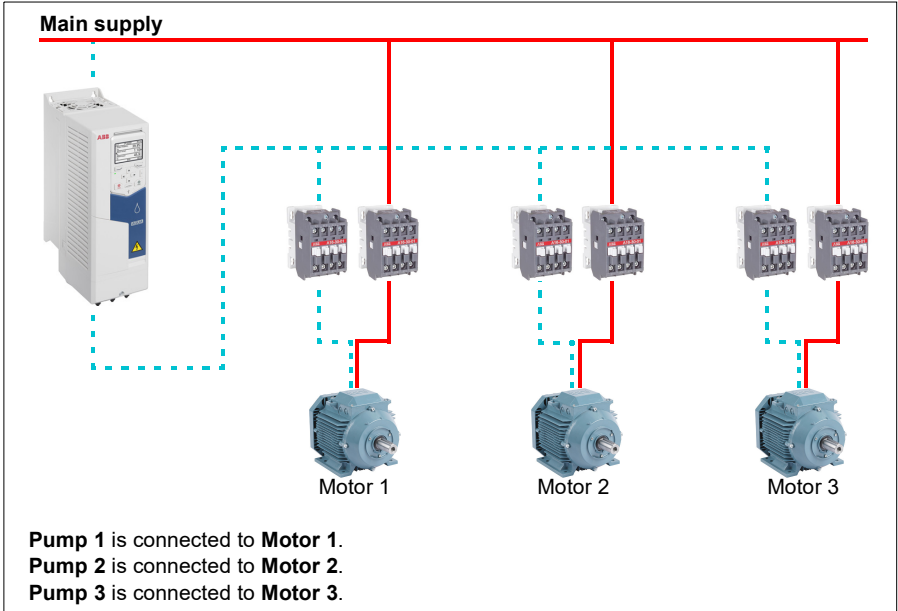

Flow consumption and pump status			
Consumption	Pump 1	Pump 2	Pump 3
Low	VSD	Off	Off
Normal	VSD	DOL	Off
↓	Off	VSD	DOL
↓	DOL	Off	VSD
Normal	VSD	DOL	Off

VSD = Controlled by drive, tuning the output speed according to PID control.

DOL = Direct On Line. Pump is running at fixed motor nominal speed.

Off = Off-line. Pump stops.

3. Autochange with SPFC

Auxiliary motor is meaningless in SPFC. So it does not matter if you select All motors or Aux motor only.

Example: Three-pump constant pressure water supply application

Two pumps fulfill the flow consumption for long term running, and the third pump is reserved for shifting.

SPFC system supports autochange naturally. No extra component is needed as long as SPFC is already working there. In this mode, all the pumps are always started by the drive as they are in SPFC normal operation.

6

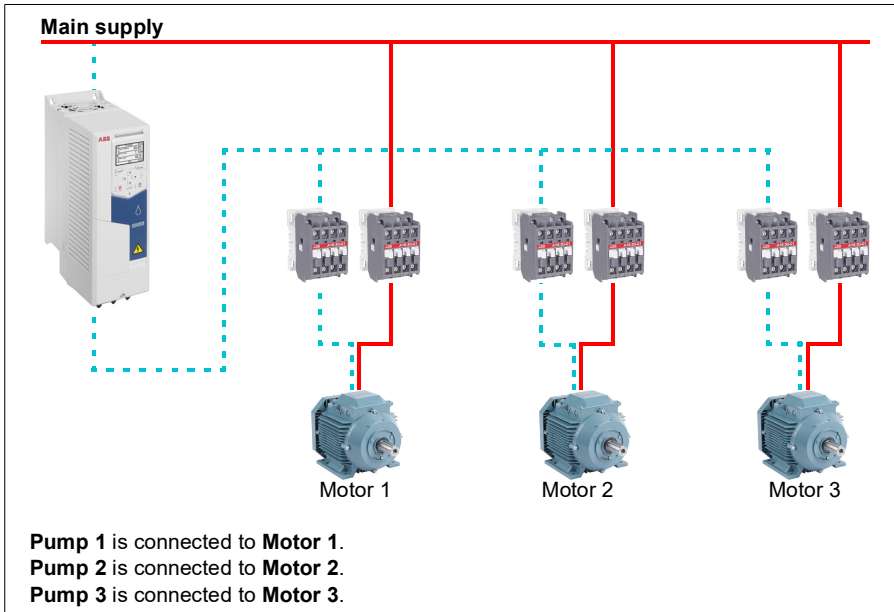

Flow consumption and pump status			
Consumption	Pump 1	Pump 2	Pump 3
Low	VSD	Off	Off
Normal	DOL	VSD	Off
↓	Off	DOL	VSD
↓	VSD	Off	DOL
Normal	DOL	VSD	Off

VSD = Controlled by drive, tuning the output speed according to PID control.

DOL = Direct On Line. Pump is running at fixed motor nominal speed.

Off = Off-line. Pump stops.

Interlock

There is an option to define interlock signals for each motor in the PFC system. When the interlock signal of a motor is available, the motor participates in the PFC starting sequence. If the signal is Interlocked, the motor is excluded. This feature can be used for informing the PFC logic that a motor is not available (for example, due to maintenance or manual direct-on-line starting).

Settings

- Parameter group [10 Standard DI, RO](#) (page [309](#))
- Parameter group [40 Process PID set 1](#) (page [437](#))
- Parameter groups [76 Multipump configuration](#) (page [484](#)) and [77 Multipump maintenance and monitoring](#) (page [497](#)).

■ Level control

The Level control function can be used to control the water level in tank filling or emptying application. The function supports up to eight pumps. The function can be enabled by setting parameter [76.21 Multipump configuration](#) to [Level control - Emptying](#) or [Level control - Filling](#).

The figure below represents a waste water pumping system in emptying mode. The system has varying water level and the pumps will start and stop based on measured level.

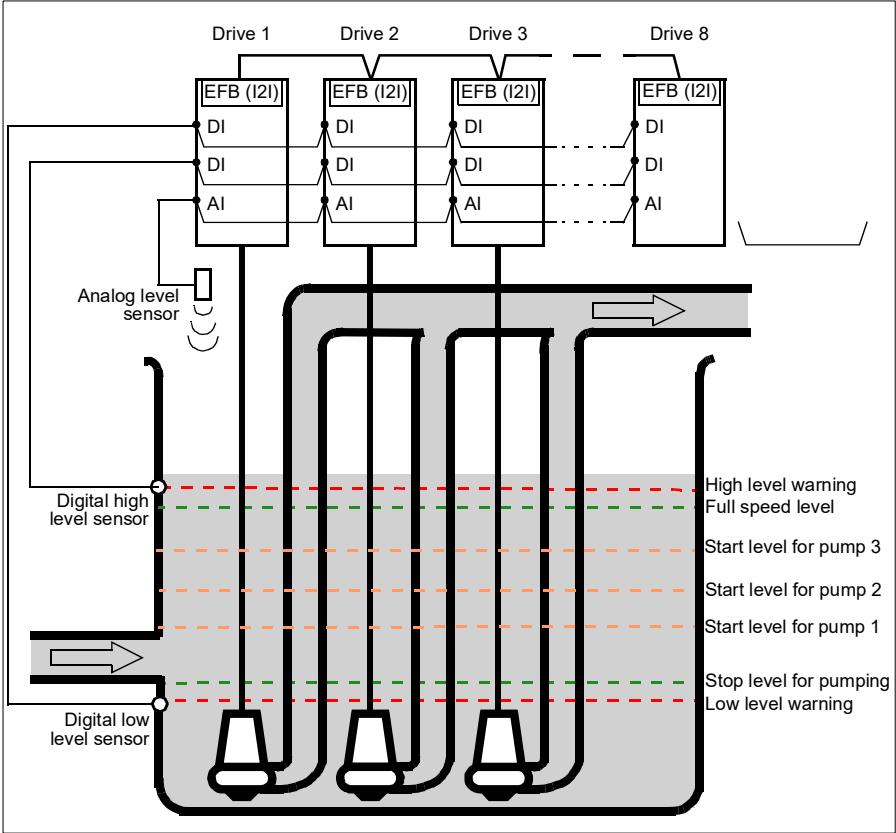

The first pump (master) will start when the actual level is above the start point 1. More pumps will start and stop based on the rising (emptying) or falling (filling) water levels of individual pumps. In case of a pump failure or if drive is disconnected for maintenance, the system continues operation with the remaining pumps and drives.

The digital high level and low level sensors can be used to generate a warning or fault when the water level in the container raises or falls to the abnormal operation area. The analog level sensor connected to an analog input measures the water level.

Settings

- Parameter group [76 Multipump configuration](#) (page 484).

Soft pipe fill

The Soft pipe fill function can be used to fill an empty pipe softly. The function can avoid sudden charge of water and rise in pressure in a closed valve or a nozzle at the end of the pump system.

The figure below illustrates the operation of the Soft pipe fill function.

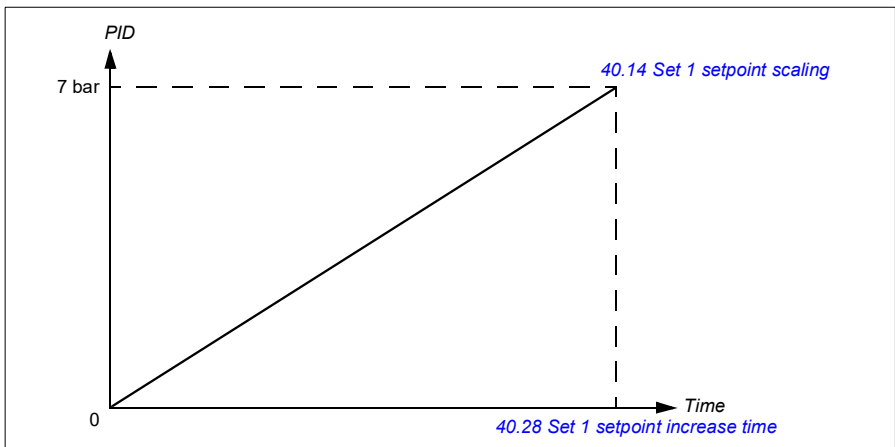

If the pumping system is leaking or is damaged then the setpoint will not reach in time. To detect such a condition, you can enable soft pipe fill supervision to generate a warning or a fault. The time is calculated with the last reference change in parameter [40.03 Process PID setpoint actual](#).

Settings

- **Menu - Primary settings - Pump features - Soft pipe fill**
- Parameter groups [40 Process PID set 1](#) (page 437) and [82 Pump protections](#) (page 505).

Sensorless flow calculation

The flow calculation function provides a reasonably accurate (typically $\pm 3\ldots 6\%$) calculation of the flow without the installation of a separate flow meter. The flow is calculated on the basis of parameter data such as pump inlet and outlet diameters, pressure at pump inlet and outlet, height difference of pressure sensors, and pump characteristics.

The user can either define a HQ (head/flow) or PQ (power/flow) performance curve that is used as the basis for the calculation. It is also possible to use differential pressure based flow feedback. Flow calculation method is selected in Primary settings or with parameter [80.13 Flow feedback function](#).

The figure below shows the HQ performance curve of the pump for the flow calculation function.

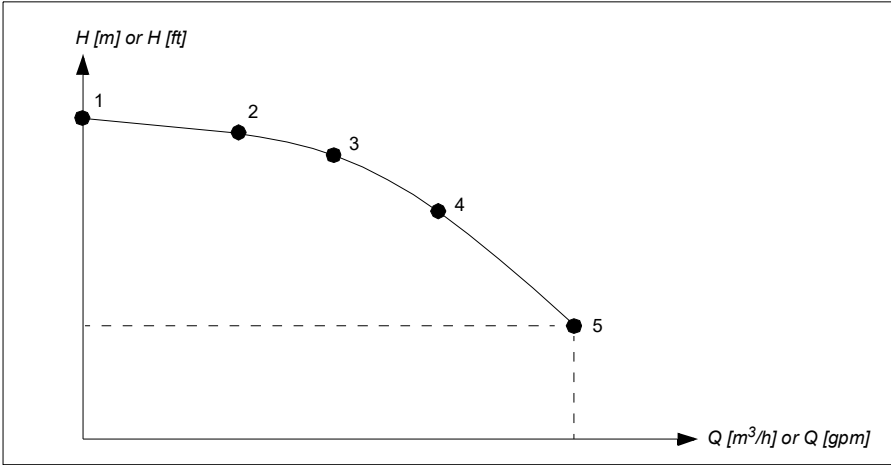

The figure below shows the PQ performance curve of the pump for the flow calculation function.

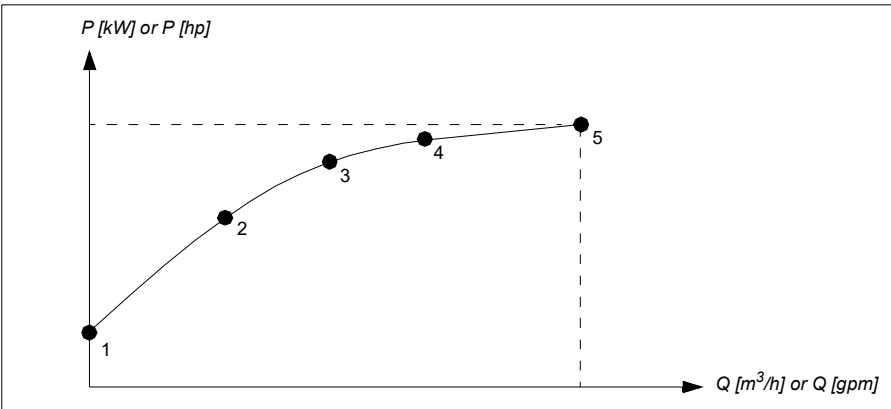

The flow calculated based on HQ or PQ curve is scaled according to the actual speed of the pump. Scaling reference speed is set in parameter [80.21 Flow pump nominal speed](#).

To increase the flow calculation accuracy, a correction factor can be entered to parameter [80.14 Flow feedback multiplier](#).

Notes:

- The flow calculation function cannot be used for invoicing purposes.
- The flow calculation function cannot be used outside the normal operating range of the pump.
- Head point H1 in HQ curve must be defined at zero flow.
- Head points in HQ curve are expected to be in descending order ($H1 > H2 > H3 > H4 > H5$).
- Power point P1 in PQ curve must be defined at zero flow.
- Power points in PQ curve are expected to be in ascending order ($P1 < P2 < P3 < P4 < P5$).

Parameter group [80 Flow calculation](#) (page 499) defines the HQ/PQ or differential pressure based flow feedback and [81 Sensor settings](#) (page 503) defines pump inlet and outlet selection for HQ calculation.

Settings

- Parameter group [80 Flow calculation](#) (page 499) and [81 Sensor settings](#) (page 503).

Pump cleaning

The pump cleaning function is mainly used in wastewater applications to prevent solid particles from being stuck on the pump impellers or in the piping. This function consists of a programmable sequence of forward and reverse rotations of the pump to shake off and remove any residue or rags on the impeller or piping.

The Pump cleaning function prevents:

- blockages and decreases the need of manual cleaning
- increases the lifetime of the pump, pipes and impellers, and
- improves energy efficiency of the system.

Pump cleaning sequence

The drive starts cleaning with a pulse in the opposite direction of the running direction. The speed step size is same for both positive and negative directions.

The pump cleaning sequence can have several positive and negative direction speed steps in one cleaning sequence.

6

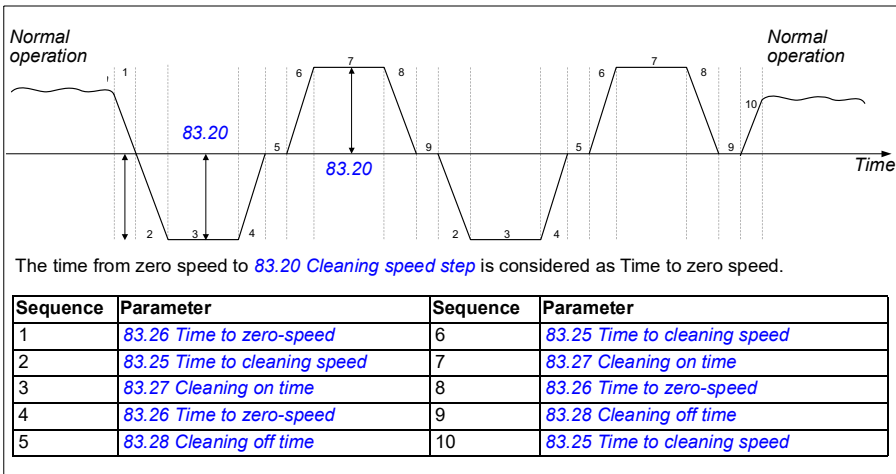

When the negative speed is not allowed, the drive ignores phases 1...4.

Note: Cleaning in a negative direction requires negative minimum speed/frequency in parameter [30.11 Minimum speed](#) / [30.13 Minimum frequency](#).

1. The pump system meets the triggering conditions defined by parameter [83.10 Pump cleaning action](#). At these conditions, normal operation stops and the drive uses the target time defined in parameter [83.26 Time to zero-speed](#) to reach zero speed.
2. Acceleration for cleaning is defined by parameter [83.25 Time to cleaning speed](#).
3. The pump runs at cleaning speed for the time defined by parameter [83.27 Cleaning on time](#).
4. The pump decelerates to zero-speed. Target time is defined by parameter [83.26 Time to zero-speed](#).
5. The pump is stopped until parameter [83.28 Cleaning off time](#) is elapsed.
6. The pump accelerates the pump speed to positive direction. See parameter [83.25 Time to cleaning speed](#).
7. The pump runs at the positive cleaning speed. See parameter [83.27 Cleaning on time](#).
8. The pump decreases the pump speed back to zero defined by parameter [83.26 Time to zero-speed](#).
9. The drive waits until the parameter [83.28 Cleaning off time](#) is elapsed. A new cleaning sequence starts or normal operation starts.
10. The pump starts following speed/frequency reference of the active control location. During acceleration to speed/frequency, the drive follows pump cleaning acceleration time [83.25 Time to cleaning speed](#).

The drive automatically determines the fastest ramp during the pump cleaning and used to protect the pump.

Note: Quick ramps are not used in pump cleaning.

The cleaning sequence starts based on the selected triggering conditions. The cleaning sequence follows the diagram on page [124](#). You can start the sequence in these conditions:

- on every start and stop
- based on the monitoring pump condition (for example, supervision 1...3; underload and overload curve, see group [37 User load curve](#) on page [433](#))
- based on time interval (for example, at every 10 hours)
- manually (for example, DI4 to DI6, defined by parameter [83.12 Manually force cleaning](#))
- through fieldbus, using parameter [83.12 Manually force cleaning](#). Set the parameter to a value of 1 (a 2 s pulse) from the fieldbus to start a cleaning cycle from an overriding controller.

Cleaning count monitoring

The cleaning count monitoring function calculates the number of cleaning cycles inside a user-defined monitoring window. Too frequent cleaning attempts may indicate a pump problem (such as blockage) that the pump cleaning function cannot solve alone but it requires manual inspection and cleaning. The following figures describes the operation of cleaning count monitoring.

For example, set the cleaning count time to one hour. The pump cleaning function trips on a fault if it detects too frequent cleaning cycles. The drive completes three pump cleaning cycles. The drive continuous its operation as long as the time interval between three cleanings are over the user defined value (one hour).

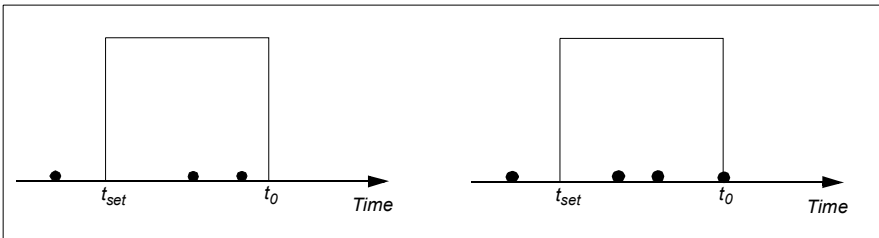

6

The third pump cleaning cycle starts within the preset count time (one hour) and the pump cleaning function trips on a fault and the pump is stopped without performing the third cleaning cycle. After resetting fault, the drive starts with the third pump cleaning cycle.

If the parameter [83.35 Cleaning count fault](#) is set to *No action*, supervision is not executed. If you change the parameter [83.35 Cleaning count fault](#) to *Warning* or *Fault*, the pump cleaning count starts from zero.

When the pump cleaning function is active and maximum number of cycles per time unit is reached, the drive displays a warning which appears in the event log.

Settings

- **Menu - Primary settings - Pump cleaning**
- Parameter group [83 Pump cleaning](#) (page [509](#)).

■ Dry pump protection

The Dry pump protection function can be used to protect the pump from getting dry. The figure below illustrates the operation of dry pump protection function.

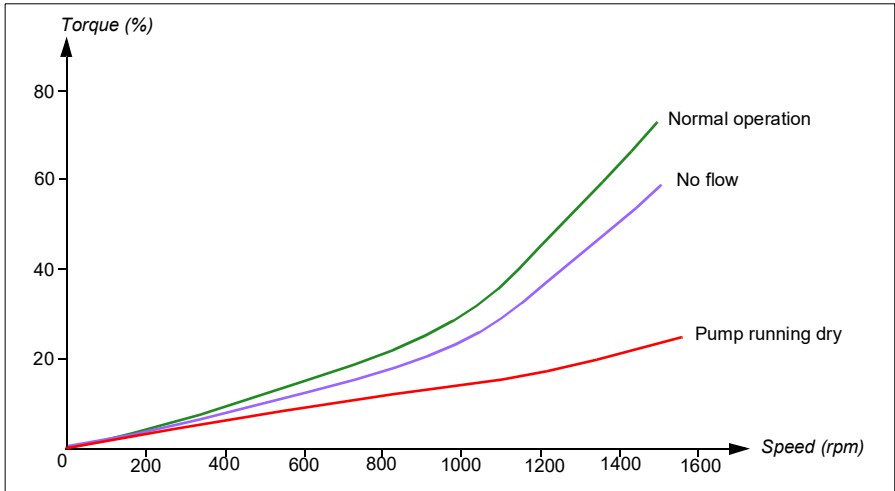

The dry pump can be detected using the underload curve, low level mechanical switch and pressure sensor.

- **Underload curve** - Detects the pump maybe getting dry and generates a warning or fault.
- **Low/high level mechanical switch** - Indicates the water level in the pump system through a digital input and generates a warning or fault.
- **Pressure sensor** - Connected to Supervision 1...3 through an analog input. The output of supervision indicates the pump inlet getting dry and generates a warning or fault.

Settings

- **Menu** -> **Primary settings** -> **Pump features** -> **Dry pump protection**
- Parameter group [82 Pump protections](#) (page 505).

■ Pump inlet and outlet protection

The Pump inlet and outlet protection function monitors pump inlet and outlet pressure and takes the user defined actions in case the pressure is outside the normal range.

The inlet and outlet minimum pressure protection function can first generate a warning when the pump pressure is below minimum pressure warning level for pressure check delay time. If the pressure continues to fall below the minimum pressure fault level, a fault is generated.

The outlet maximum pressure protection function can first generate a warning when the pump outlet pressure is above maximum pressure warning level for pressure check delay time. If the pressure continues to rise above the maximum pressure fault level, a fault is generated.

Settings

- Menu -> **Primary settings** -> **Pump features** -> **Pressure protection**
- Parameter group [81 Sensor settings](#) (page 503) and [82 Pump protections](#) (page 505).

■ Ramps – Quick ramps

The quick ramp function allows use of two additional ramp sets to accelerate or decelerate the pump. The following figure illustrates the acceleration in a quick ramp mode when both additional ramp sets are used.

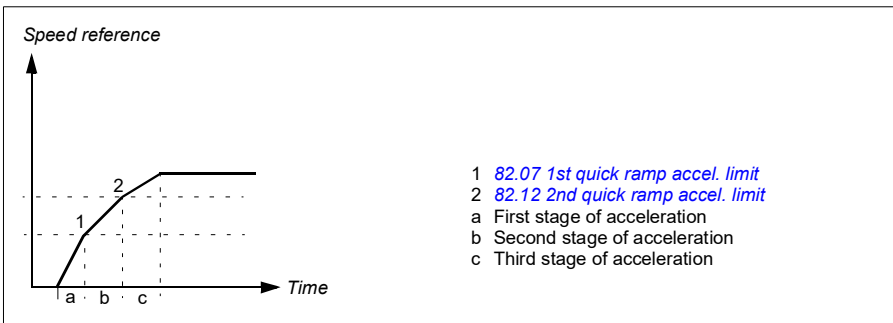

In submersible (a.k.a borehole) pumps, the mechanical wearing of bearings can be reduced by ramping the pump quickly to a certain speed.

For ramps in general, see section [Ramps](#) on page 135.

Note: ABB recommends reading the pump manufacturer's instructions for safe operation and optimal performance.

Quick ramps are enabled for acceleration with parameters [82.01 Quick ramp accel. mode](#). Quick ramps for deceleration are enabled with parameter [82.02 Quick ramp decel. mode](#). Both acceleration and deceleration can use either 1 quick ramp or 2 quick ramps. Parameter [82.02 Quick ramp decel. mode](#) can also use the value [Follow accel. limits](#), which will use the same configuration (mode and limits) for both deceleration and acceleration.

Also if parameter [21.03 Stop mode](#) is selected to be [Coast](#), then Quick ramp 1 decel. and Quick ramp 2 decel. are not used because the drive is stopped by coasting.

Starting with software version 2.12 (released in spring 2020), two quick ramp modes are available:

- Legacy mode is compatible with software before version 2.12.
- Updated functionality allows more control over the quick ramp feature.

Legacy mode

Legacy mode can be used by specifying legacy mode selections for parameter 82.01 Quick ramp accel. mode or parameter [82.02 Quick ramp decel. mode](#). The legacy mode selections use parameters [46.01 Speed scaling](#) and [46.02 Frequency scaling](#) for Quick ramp 1, Quick ramp 2, and Operational quick ramp definitions.

Note: If either acceleration or deceleration is using updated functionality quick ramp(s) instead of legacy mode, both will use the updated functionality quick ramp mode.

The following example describes the first, second and third stage of acceleration in quick ramp legacy mode.

- The first stage of acceleration (a) is to lift the impeller so that the fluid protects the bearings and sealings. Otherwise, the pump can get damaged. For example, 0 to 25/30 Hz with ramp time of 1 second.
- The second stage of acceleration (b) is optional. The pump produces a valid flow in this region, so the reasonable acceleration rate is requested to overcome the static head and limit the turbidity. The effective inside region is 25/30 to 43/45 Hz and the ramp times typically are between 10 to 45 seconds.

Note: Acceleration time is proportional to full speed range. This means that if quick ramp 2 is configured from 20 to 40 Hz, set time is 30 seconds and the full speed is 60 Hz, the actual acceleration time from 20 to 40 Hz is 10 seconds. The full speed value is defined by parameter [46.01 Speed scaling](#) or [46.02 Frequency scaling](#).

- The third stage of acceleration (c) is a normal ramp. The pump provides a reasonable flow rate. The drive uses normal ramp times, for example, 60 seconds.

Example:

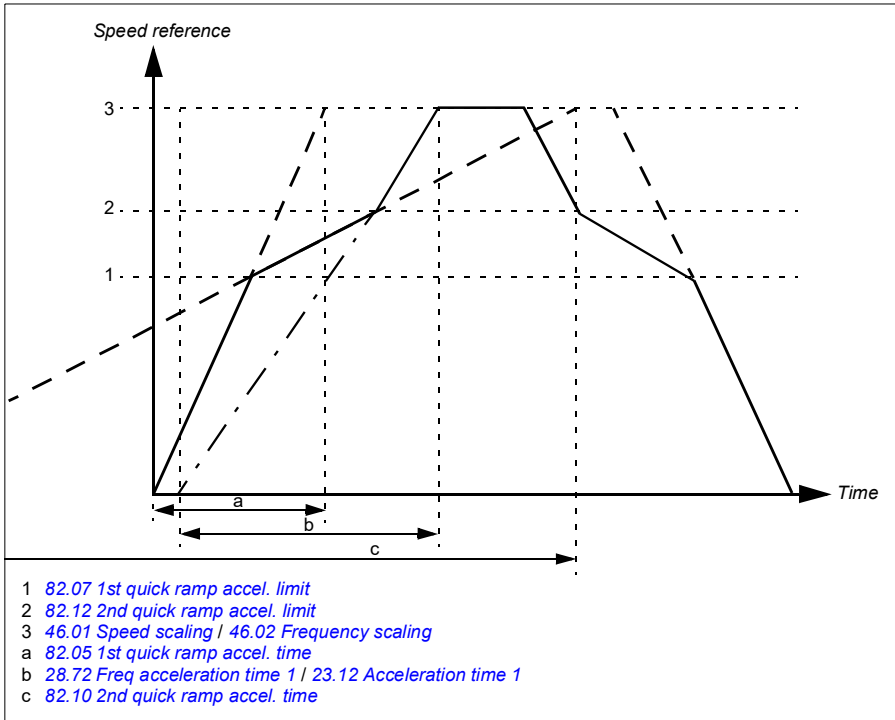

Updated functionality

Updated functionality can be used by specifying other than legacy mode selections for parameter [82.01 Quick ramp accel. mode](#) or parameter [82.02 Quick ramp decel. mode](#).

With updated functionality, ramps are handled by separate operational ramp acceleration/deceleration time parameters:

- [82.14 Oper. quick ramp accel. time \(3rd\)](#)
- [82.15 Oper. quick ramp decel. time \(1st\)](#).

If any quick ramp function (acceleration or deceleration) is selected, both acceleration and deceleration are based on the quick ramp parameters [82.14](#) and [82.15](#). Normal acceleration/deceleration values from the frequency/speed chain are ignored. The final ramp is calculated from the last active quick ramp limit.

The acceleration rate is defined as the time to accelerate from zero speed to the speed value defined by parameter [46.01 Speed scaling](#) or [46.02 Frequency scaling](#). This acceleration rate is effective from zero to speed/frequency defined by parameter [82.07 Final quick ramp decel. limit](#).

Settings

- **Menu > Primary settings > Ramps > Quick ramps**
- Pump protections - Quick ramps: Parameter group [82 Pump protections](#) (page [505](#)).

Automatic fault resets

The drive can automatically reset itself after overcurrent, overvoltage, undervoltage and external faults. The user can also specify a fault that is automatically reset.

By default, automatic resets are off and must be specifically activated by the user.



WARNING! Before you activate the function, make sure that no dangerous situations can occur. The function resets the drive automatically and continues operation after a fault.

Settings

- **Menu > Primary settings > Advanced functions > Autoreset faults**
- Parameters [31.12...31.16](#) (page [394](#)).

External events

Five different event signals from the process can be connected to selectable inputs to generate trips and warnings for the driven equipment. When the signal is lost, an external event (fault, warning, or a mere log entry) is generated. The contents of the messages can be edited on the control panel.

Settings

- **Menu > Primary settings > Advanced functions > External events**
- Parameters [31.01...31.10](#) (page [392](#)).

Constant speeds/frequencies

Constant speeds and frequencies are predefined references that can be quickly activated, for example, through digital inputs. It is possible to define up to 7 speeds for speed control and 7 constant frequencies for frequency control.



WARNING: Speeds and frequencies override the normal reference irrespective of where the reference is coming from.

Settings

- **Menu > Primary settings > Start, stop, reference > Constant speeds**
 - **Menu > Primary settings > Start, stop, reference > Constant frequencies**
 - Parameter groups [22 Speed reference selection](#) (page [362](#)) and [28 Frequency reference chain](#) (page [377](#)).
-

■ Critical speeds/frequencies

Critical speeds (sometimes called “skip speeds”) can be predefined for applications where it is necessary to avoid certain motor speeds or speed ranges because of, for example, mechanical resonance problems.

The critical speeds function prevents the reference from dwelling within a critical band for extended times. When a changing reference ([22.87 Speed reference act 7](#)) enters a critical range, the output of the function ([22.01 Speed ref unlimited](#)) freezes until the reference exits the range. Any instant change in the output is smoothed out by the ramping function further in the reference chain.

When the drive is limiting the allowed output speeds/frequencies, it limits to the absolutely lowest critical speed (critical speed low or critical frequency low) when accelerating from standstill, unless the speed reference is over the upper critical speed/ frequency limit.

The function is also available for scalar motor control with a frequency reference. The input of the function is shown by [28.96 Frequency ref act 7](#), the output by [28.97 Frequency ref unlimited](#).

6

Example for critical speeds:

A pump has vibrations in the range of 540...690 rpm and 1380...1560 rpm. To make the drive avoid these speed ranges,

- enable the critical speeds function by turning on bit 0 of parameter [22.51 Critical speed function](#), and
- set the critical speed ranges as in the figure below.

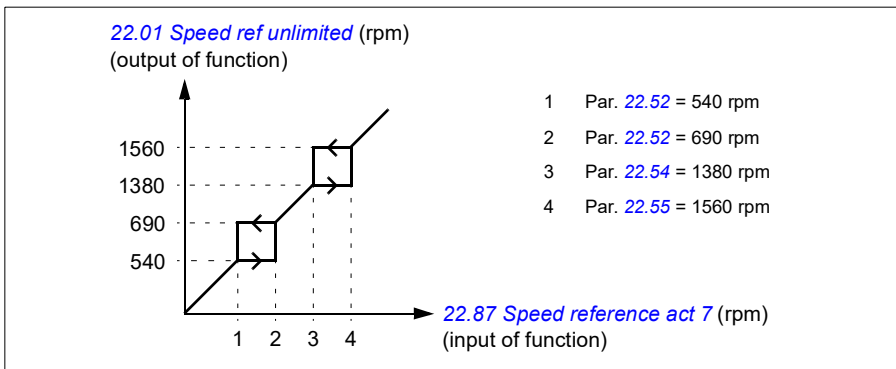

Example for critical frequencies:

A pump has vibrations in the range of 18...23 Hz and 46...52 Hz. To make the drive avoid these frequency ranges,

- enable the critical frequencies function by turning on bit 0 of parameter [28.51 Critical frequency function](#), and
- set the critical frequency ranges as in the figure below.

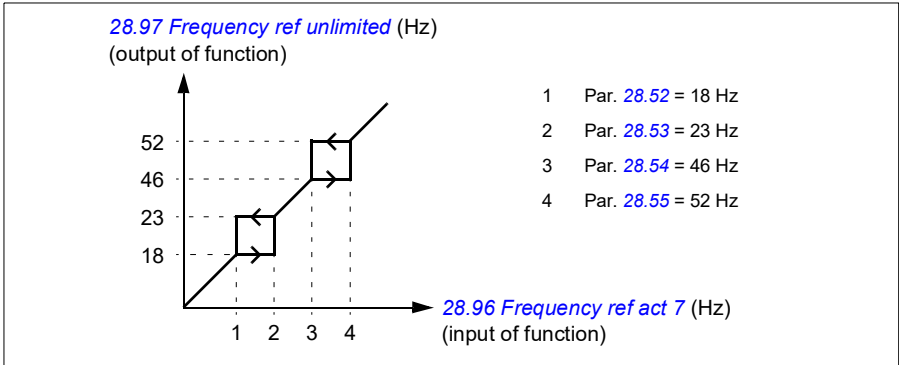

Settings

- **Menu > Primary settings > Start, stop, reference > Constant speeds**
- **Menu > Primary settings > Start, stop, reference > Constant frequencies**
- Critical speeds: parameters [22.51](#)...[22.57](#) (page [367](#))
- Critical frequencies: parameters [28.51](#)...[28.57](#) (page [382](#)).

Timed functions

The base entity of the timed functions is called a timer. A timer can be active based on time of the day, day of the week and season of the year. In addition to these time related parameters, the timer activation can be influenced by so called days of exception (configurable as holiday or workday). For example, 25.12. (Dec 25th) can be defined as holiday in many countries. A timer can be set to be active or inactive during the days of exception.

Several timers can be connected to a timed function with the OR function. Thus if any of the timers connected to a timed function is active, the timed function is also active. The timed function is then in turn controlling normal drive functions like starting the drive, choosing the right speed or right setpoint for the PID loop controller.

In many cases where a pump or other equipment is controlled with a timed function, it is often required that there is a possibility to override the time program for a short while. The overriding functionality is called boost. The boost is directly affecting selected timed function(s) and switches it (them) on for a predefined time. The boost mode is typically activated through a digital input and its operation time is set in parameters.

A diagram illustrating the relations of the timed functions entities is shown below.

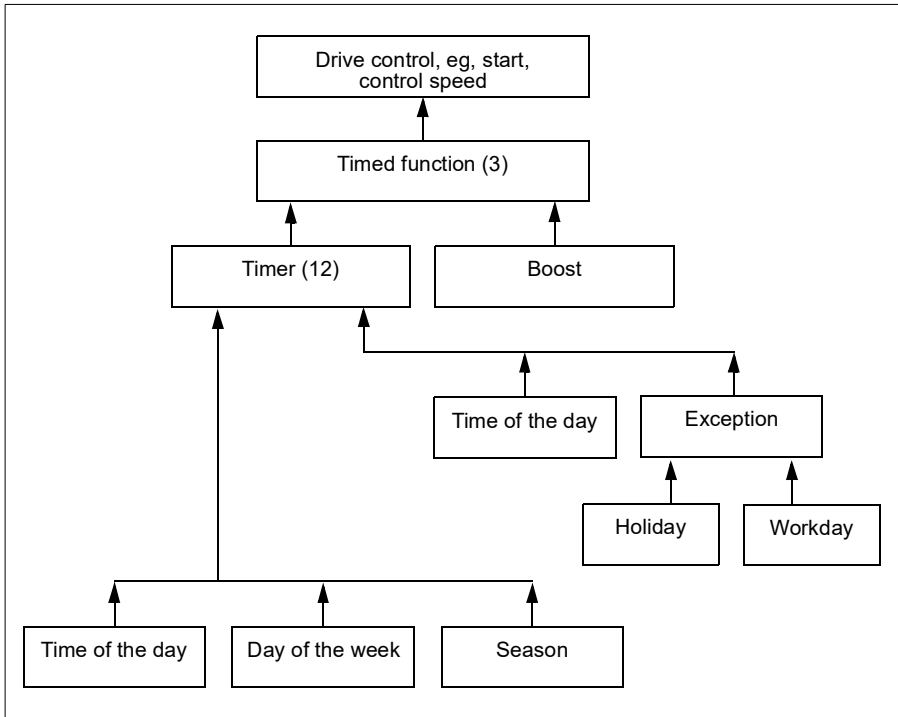

Settings

- **Menu > Primary settings > Advanced functions > Timed functions**
- Parameter group [34 Timed functions](#) (page 410).

Ramps

Overview

Ramps refer to acceleration and deceleration times. The ramps function adjusts the rate of how fast or slow a drive changes the motor speed with respect to the commanded speed. Ramps should be configured based on the specific application requirements.

Additional quick ramps are provided for starting submersible pumps. See section [Ramps – Quick ramps](#) on page 128.

Functionality

Acceleration ramps are recommended for all applications. The acceleration ramp is the amount of time required for the drive to ramp up the motor from 0 Hz to the ramp time target frequency setting. The Ramp time target frequency setting is located under **Menu > Primary Settings > Ramps**.

The deceleration ramp is the amount of time required for the drive to ramp down from the ramp time target frequency to 0 Hz. The most typical settings of ramp time target frequency are 50 Hz outside of North America and 60 Hz for North America. Note that the ramps function is always active during operation and not just used for starting and stopping modes.

If the stop mode is set to coast, it will cause the drive to ignore the deceleration ramp while stopping. In this scenario, the drive will no longer be controlling the speed of the motor once the run command is removed. The figure below shows a ramp curve for 90-second acceleration and no deceleration.

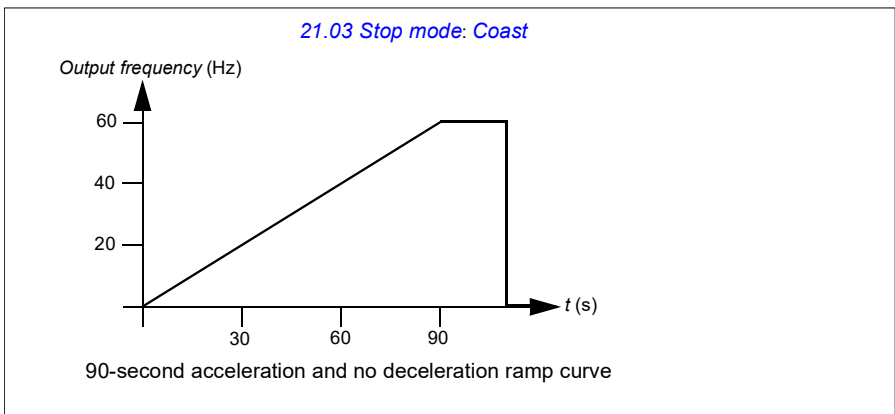

In pump applications, the stop mode is typically set to ramp and the deceleration ramp is used while stopping. Ramping a pump motor to a stop helps prevent issues

such as water hammer and assist in closing the check valve. The figure below shows a ramp curve for 30-second acceleration and deceleration.

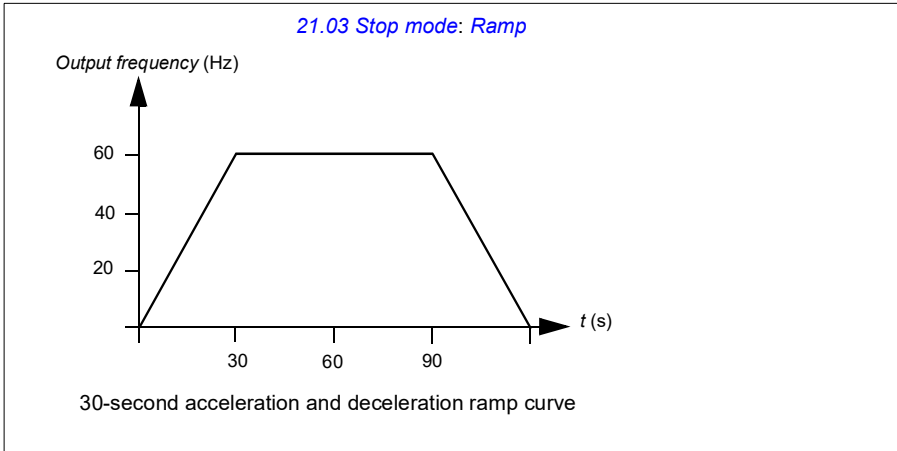

6

If the acceleration time is too short, the drive may trip out on overcurrent. If the deceleration ramp is set to stop too quickly, the drive may trip out on overvoltage. These scenarios are unlikely in most applications due to the internal current and voltage limiting features built into the drive. However, the desired ramps times will not be achieved in such circumstances.

Each application and motor is unique. As a general guideline for pumps, ramp times are often set between 30 and 90 seconds. Typically a larger drive/motor has a longer ramp time. However, certain applications or pump types require a much faster or slower ramp time.

Settings

- **Menu > Primary settings > Ramps**
- Speed reference ramping: Parameters [23.12](#)...[23.13](#) and [46.01](#) (pages [370](#) and [462](#))
- Frequency reference ramping: Parameters [28.72](#)...[28.73](#) and [46.02](#) (pages [383](#) and [462](#))
- Motor potentiometer: Parameter [22.75](#) (page [369](#))
- Emergency stop (“Off3” mode): Parameter [23.23](#) *Emergency stop time* (page [371](#)).

Process PID control (PID/Loop controller)

There are two built-in process PID controllers (PID set 1 and PID set 2) in the drive. The controller can be used to control process variables such as pressure or flow in the pipe or fluid level in the container.

In process PID control, a process reference (setpoint) is connected to the drive instead of a speed reference. An actual value (process feedback) is also brought back to the drive. The process PID control adjusts the drive speed in order to keep the measured process quantity (actual value) at the desired level (setpoint). This means that user does not need to set a frequency/speed/torque reference to the drive but the drive adjust its operation according to the process PID.

The simplified block diagram below illustrates the process PID control. For more detailed block diagrams, see pages [277](#) and [279](#).

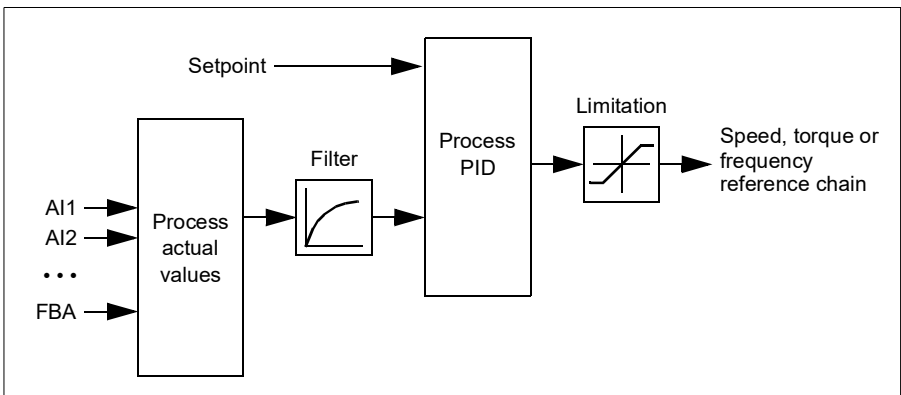

The drive contains two complete sets of process PID controller settings that can be alternated whenever necessary; see parameter [40.57 PID set1/set2 selection](#).

Note: Process PID control is only available in external control location EXT2; see section [Local control vs. external control](#) (page [87](#)).

Sleep and boost functions for process PID control

The sleep function is suitable for PID control applications where the consumption varies, such as clean water pumping systems. When used, it stops the pump completely during low demand, instead of running the pump slowly below its efficient operating range. The following example visualizes the operation of the function.

Example: The drive controls a pressure boost pump. The water consumption falls at night. As a consequence, the process PID controller decreases the motor speed. However, due to natural losses in the pipes and the low efficiency of the centrifugal pump at low speeds, the motor would never stop rotating. The sleep function detects the slow rotation and stops the unnecessary pumping after the sleep delay has passed. The drive shifts into sleep mode, still monitoring the pressure. The pumping

resumes when the pressure falls under the predefined minimum level and the wake-up delay has passed.

The user can extend the PID sleep time by the boost functionality. The boost functionality increases the process setpoint for a predetermined time before the drive enters the sleep mode.

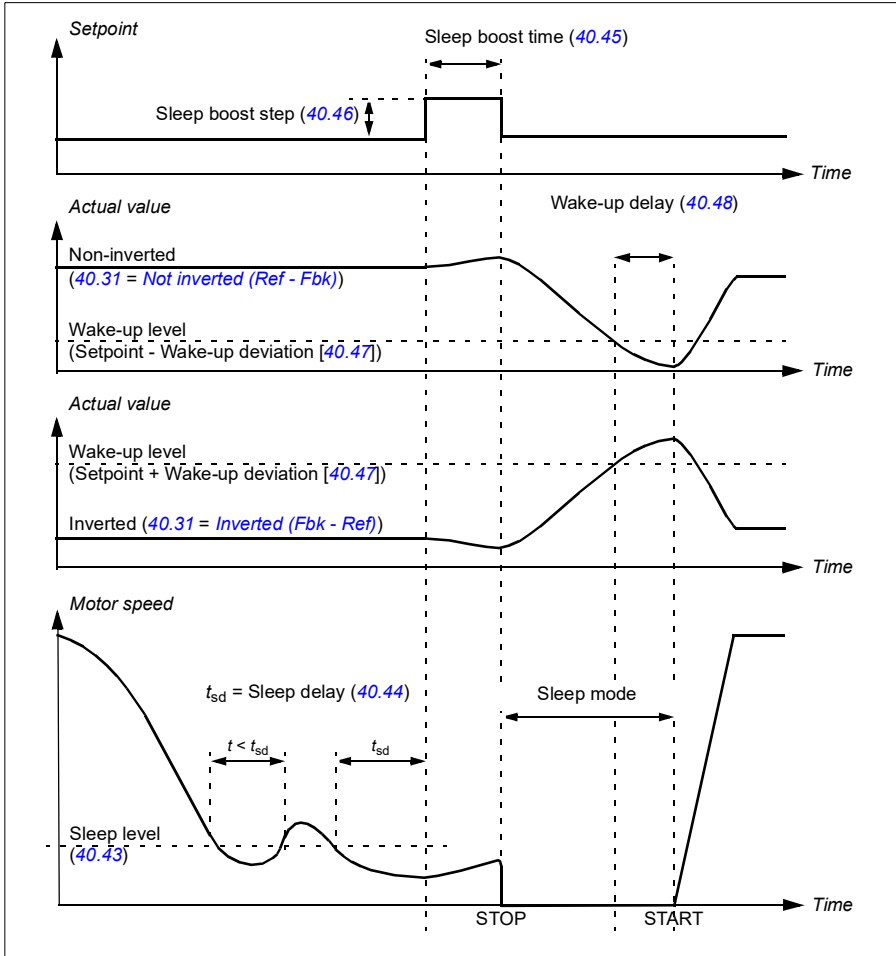

6

Tracking

In tracking mode, the PID block output is set directly to the value of parameter [40.50](#) (or [41.50](#)) *Set 1 tracking ref selection*. The internal I term of the PID controller is set so that no transient is allowed to pass on to the output, so when the tracking mode is left, normal process control operation can be resumed without a significant bump.

Settings

- Parameter groups [40 Process PID set 1](#) (page [437](#)) and [41 Process PID set 2](#) (page [453](#)).

Limits

■ Limits overview

The drive has multiple limits that can be set to prevent the drive from causing damage to the motor or the pump system. Limits can be applied to the minimum and maximum frequency, speed, or torque and the maximum current. Frequency limits are used in scalar motor control mode, while speed limits are used in vector motor control mode.

Setting a minimum speed/frequency may be used to prevent a pump or motor from overheating. Running a certain pump or motor type at too slow a speed will decrease its ability to cool itself. Equipment that runs warmer, or lacks proper lubrication, will likely have a shorter lifespan. Consult the equipment manufacturer for minimum speed/frequency settings.

Setting a maximum speed/frequency may be used to prevent excessive mechanical stress. Mechanical stress at levels above the equipment's design will likely shorten the lifespan of the equipment. Consult the equipment manufacturer to determine the maximum safe speed/frequency.

6

The maximum current setting will prevent steady-state operation above a specific current operation. Note that this setting is unrelated to the motor overload protection, which is configured based on actual motor current information entered into the drive.

Settings

- **Menu > Primary Settings > Limits**
- Parameter group [30 Limits](#).

Interlocks

■ Overview

Interlocks provide a way to prevent the drive from running when an input is not satisfied. The interlock feature of the drive is often used to wire safeties back to the drive. ABB does not recommend wiring interlocks in series with each other, unless there are more than four interlocks. Wiring interlocks separately allows for faster system troubleshooting, as the drive provides quick identification on which individual interlock is no longer satisfied. Monitoring the status of each interlock is available over fieldbus communications.

Interlocks typically are wired to the drive's digital inputs (DI), DI1 through DI6. Certain fieldbus communications can also be used to control interlocks, although typically not recommended for most applications.

■ Configuration

You can configure interlocks either in the **Primary settings** menu, or via parameter group [20 Start/stop/direction](#) in the **Parameters** menu. ABB recommends configuration via the **Primary settings** menu (**Menu > Primary settings > Start, stop, reference > Interlocks/permissives**).

Interlocks are configurable for normally open or normally closed functionality.

- For example, in the **Primary settings**, selecting an interlock for DI4 high indicates that digital input 4 must be closed, or logic 1, to allow the drive to run. A setting of DI4 low indicates the digital input must be open, or logic 0, to allow the drive to run. If the interlock is not in a logic state that will allow the drive to run, the interlock is unsatisfied. If the interlock is in a logic state that will allow the drive to run, the interlock is satisfied.

An unsatisfied interlock is indicated on the drive control panel display via a flashing green LED light, and a flashing warning on the display. You can set up the drive to indicate an unsatisfied interlock in one of two methods (**Menu > Primary settings > Start, stop, reference > Interlocks/permissives > Interlock warning condition**). This setting applies to all the interlocks.

- Indicate a warning, whenever an interlock is unsatisfied, regardless of a run command.
- Indicate a warning, whenever an interlock is unsatisfied and a run command is present.

You can configure the drive for either coast or ramp to a stop, when the interlock changes to an unsatisfied state (**Menu > Primary settings > Start, stop, reference > Interlocks/permissives > Interlock stop mode**).

■ Wiring connections

Interlocks function in both Auto and Hand control modes. ABB recommends that the system interlocks are wired directly to the drive, and not to an external PLC/SCADA.

Failure to wire the interlock(s) directly to the drive can inadvertently allow Hand mode operation, when an interlock is not satisfied.

■ Functionality

The drive allows predefined descriptive text and label text (free text) to be independently associated with each of the four different interlocks. The control panel display will display that specific text when the interlock becomes unsatisfied.

You configure (select) the predefined descriptive text in **Menu > Primary settings > Start, stop, reference > Interlocks/Permissives > Descriptive text**.

You configure (edit) the label text in **Menu > Primary settings > Start, stop, reference > Interlocks/Permissives > Label text**.

Settings and diagnostics

6

- **Menu > Primary settings > Start, stop, reference > Interlocks/Permissives**
 - Parameter [20.41 Start interlock 1](#) (page [350](#))
 - Warnings [AFEE Start interlock 1](#), [AFEF Start interlock 2](#), [AFF0 Start interlock 3](#), and [AFF1 Start interlock 4](#).
-

Run permissives

■ Overview

The run permissive function provides a way to prevent the drive from outputting to a motor when an input is not satisfied. This function is used to support applications that require the drive to first trigger an external event before the drive starts to ramp the motor. Run permissive is often used in conjunction with an end-switch wired back to the drive. Monitoring the status of the run permissive is available over fieldbus communications.

Run permissive is different from start interlock:

- A run permissive makes the drive enter a run state but does not provide an output to the motor.
- An unsatisfied run permissive input will only indicate a warning on the control panel display if a start command is also provided. No warning will be provided if the start command is not present. Start interlock is configurable to acknowledge, or ignore, the start command status when determining if a warning must be indicated.

The run permissive is typically wired to one of the drive's digital inputs (DI), DI1 through DI6. DI2 is most commonly used. Certain fieldbus communications can also be used to control run permissive, although typically not recommended for most applications.

■ Configuration

You can configure run permissive either in the **Primary settings** menu, or via parameter group [20 Start/stop/direction](#) in the **Parameters** menu. ABB recommends configuration via the **Primary settings** menu (**Menu > Primary settings > Start, stop, reference > Interlocks/permissives**). Run permissive is configurable for normally open or normally closed functionality.

■ Wiring connections

The run permissive functions in both Auto and Hand control modes. ABB recommends that any system permissive is wired directly to the drive and not to an external PLC/SCADA.

Failure to wire the permissive directly to the drive can inadvertently allow Hand mode operation when a permissive is not satisfied.

■ Functionality

The drive allows predefined Descriptive text, and Label text (free text), to be associated with the Run permissive. The control panel will display that specific text when the permissive becomes unsatisfied.

- You configure (select) the predefined descriptive text in **Menu > Primary settings > Start, stop, reference > Interlocks/Permissives > Descriptive text**.
- You configure (edit) the label text in **Menu > Primary settings > Start, stop, reference > Interlocks/Permissives > Label text**.

Run permissive features include the following:

- With no run command issued and run permissive not satisfied, no warning is displayed.
- With a start command issued and run permissive not satisfied, the drive displays a warning that the run permissive is missing, the status LED will flash green, and the control panel's direction arrow is dashed and rotating. The drive remains in running mode, but does not output to the motor until run permissive is satisfied.
- During normal operation of the motor, if run permissive changes state, the drive will coast to stop and display a warning that run permissive is keeping the drive from outputting to the motor.
- Relay settings that are not affected by run permissive input not being satisfied include: Ready run, Enabled, Started and Running. Relay settings that are affected by run permissive include: Warning and Fault/Warning.

Settings and diagnostics

- **Menu > Primary settings > Start, stop, reference > Interlocks/permissives**
- Parameter [20.40 Run permissive](#) (page [350](#))
- Warning [AFED Run permissive](#).

■ Application example 1: Valve opening

The Run permissive function is used in valve control to prevent the pump from running until the valve is opened. Sequence of operation:

1. Drive receives start command, either via Hand or Auto source.
2. Drive verifies safeties are satisfied and valve position has not yet been satisfied.
3. Drive activates a relay output that was programmed to Valve opening (could have also been programmed to Started or Running). This relay allows power to the actuator.
4. Once the valve is opened, run permissive is satisfied and the drive outputs to the motor.

Motor control

■ Frequency control mode

The motor follows a frequency reference given to the drive. Frequency control is available in both local and external control. It is supported in scalar motor control only.

Frequency control uses frequency reference chain. Select frequency reference with parameters in group [28 Frequency reference chain](#) on page [377](#).

■ Scalar motor control

Scalar motor control is the default motor control method. In scalar control mode, the drive is controlled with a frequency reference. However, the excellent performance of vector control is not achieved in scalar control.

It is recommended to activate scalar motor control mode in the following situations:

- If the exact nominal motor values are not available or the drive needs to run different motor after the commissioning phase
- If a short commissioning time is needed or no ID run is wanted
- In multimotor systems: 1) if the load is not equally shared between the motors, 2) if the motors are of different sizes, or 3) if the motors are going to be changed after motor identification (ID run)
- If the nominal current of the motor is less than 1/6 of the nominal output current of the drive
- If the drive is used without a motor connected (for example, for test purposes)
- If the drive is equipped with a sine filter.

In scalar control, some standard features are not available.

See also section [Operating modes of the drive](#) (page [90](#)).

IR compensation for scalar motor control

R compensation (also known as voltage boost) is available only when the motor control mode is scalar. When IR compensation is activated, the drive gives an extra voltage boost to the motor at low speeds. IR compensation is useful in applications, such as positive displacement pumps, that require a high break-away torque.

In vector control, no IR compensation is possible or needed as it is applied automatically.

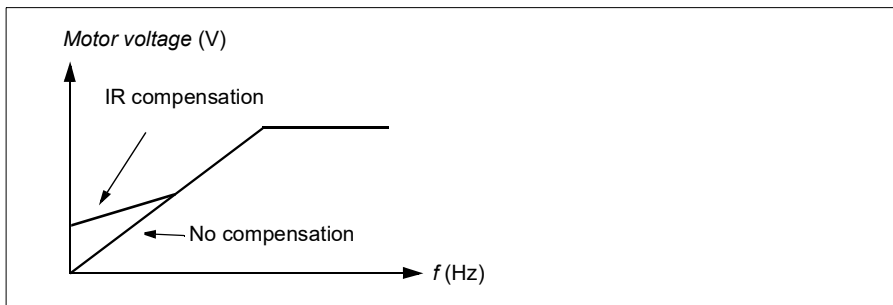

Settings

- **Menu > Primary settings > Motor > IR compensation**
- Parameters [97.13 IR compensation](#) (page 530), [97.94 IR comp max frequency](#) (page 531) and [99.04 Motor control mode](#) (page 534)
- Parameter group [28 Frequency reference chain](#) (page 377).

6

Speed control mode

The motor follows a speed reference given to the drive. This mode can be used with estimated speed used as feedback.

Speed control mode is available in both local and external control. It is supported in vector motor control only.

Speed control uses speed reference chain. Select speed reference with parameters in group [22 Speed reference selection](#) on page 362.

Vector motor control

Vector control is the motor control mode that is intended for applications where high control accuracy is needed. It offers better control over whole speed range, in particular in applications where slow speed with high torque is needed. It requires an identification run at startup. Vector control cannot be used in all applications, for example, when sine filters are being used or there are multiple motors connected to single drive.

The switching of the output semiconductors is controlled to achieve the required stator flux and motor torque. The reference value for the torque controller comes from the speed controller.

Stator flux is calculated by integrating the motor voltage in vector space. Rotor flux can be calculated from stator flux and the motor model. Motor torque is produced by controlling current 90 degrees from the rotor flux. By utilizing the identified motor

model, the rotor flux estimate is improved. Actual motor shaft speed is not needed for the motor control.

Settings

- **Menu > Primary settings > Motor > Control mode**
- Parameters [99.04 Motor control mode](#) (page 534) and [99.13 ID run requested](#) (page 536)

■ Autophasing

Autophasing is an automatic measurement routine to determine the angular position of the magnetic flux of a permanent magnet synchronous motor. The motor control requires the absolute position of the rotor flux in order to control motor torque accurately.

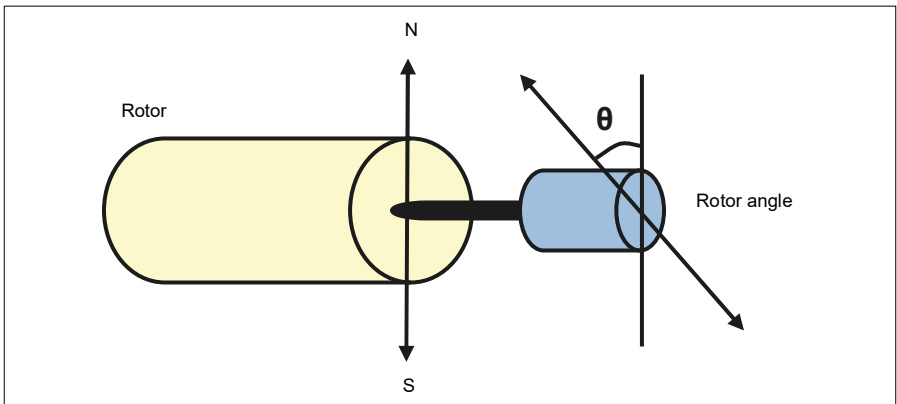

The autophasing routine is performed with permanent magnet synchronous motors to determine the rotor angle at every start.

Note: The motor always turns when it is started as the shaft is turned towards the remanence flux.

Two autophasing modes are available, see parameter [21.13 Autophasing mode](#) (page 357).

If the autophasing routine fails, the drive trips an autophasing fault ([3385 Autophasing](#), page 206).

Settings and diagnostics

- Parameters: [21.13 Autophasing mode](#) (page 357), [99.13 ID run requested](#) (page 536)
- Fault [3385 Autophasing](#) on page 206.

■ Motor types

The drive supports asynchronous AC induction, permanent magnet (PM) and synchronous reluctance motors (SynRM).

■ Motor identification

The performance of vector control is based on an accurate motor model determined during the motor start-up.

A motor identification magnetization is automatically performed the first time the start command is given. During this first start-up, the motor is magnetized at zero speed for several seconds and the motor and motor cable resistance are measured to allow the motor model to be created. This identification method is suitable for most applications.

In demanding applications a separate Identification run (ID run) can be performed.

Settings

- **Menu > Primary settings > Motor > Control mode > Vector control**
- Parameter [99.13 ID run requested](#) (page [536](#)).

6

■ U/f ratio

The *U/f* function is only available in scalar motor control mode, which uses frequency control.

The function has two modes: linear and squared.

In linear mode, the ratio of voltage to frequency is constant below the field weakening point. This is used in constant torque applications where it may be necessary to produce torque at or near the rated torque of the motor throughout the frequency range

In squared mode (default), the ratio of the voltage to frequency increases as the square of the frequency below the field weakening point. This is typically used in centrifugal pump applications. For these applications, the torque required follows the square relationship with frequency. Therefore, if the voltage is varied using the square relationship, the motor operates at improved efficiency and lower noise levels in these applications. Thus using squared mode saves energy.

The *U/f* function cannot be used with energy optimization; if parameter [45.11 Energy optimizer](#) is set to *Enable*, parameter [97.20 U/F ratio](#) is ignored.

Settings

- **Menu > Primary settings > Motor > U/f ratio**
- Parameter [97.20 U/F ratio](#) (page [531](#)).

Flux braking

The drive can provide greater deceleration by raising the level of magnetization in the motor. By increasing the motor flux, the energy generated by the motor during braking can be converted to motor thermal energy.

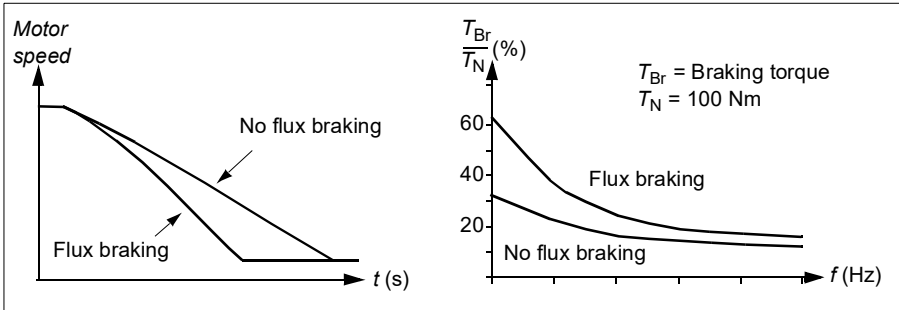

The drive monitors the motor status continuously, also during flux braking. Therefore, flux braking can be used both for stopping the motor and for changing the speed. The other benefits of flux braking are:

- The braking starts immediately after a stop command is given. The function does not need to wait for the flux reduction before it can start the braking.
- The cooling of the induction motor is efficient. The stator current of the motor increases during flux braking, not the rotor current. The stator cools much more efficiently than the rotor.
- Flux braking can be used with induction motors and permanent magnet synchronous motors.

Two braking power levels are available:

- Moderate braking provides faster deceleration compared to a situation where flux braking is disabled. The flux level of the motor is limited to prevent excessive heating of the motor.
- Full braking exploits almost all available current to convert the mechanical braking energy to motor thermal energy. Braking time is shorter compared to moderate braking. In cyclic use, motor heating may be significant.



WARNING: The motor needs to be rated to absorb the thermal energy generated by flux braking.

Settings

- **Menu > Primary settings > Motor > Flux braking**
- Parameter [97.05 Flux braking](#) (page [528](#)).

■ Start methods – DC magnetization

The drive has different magnetization functions for different phases of motor start/rotation/stop: pre-heating (motor heating), pre-magnetization, DC hold and post-magnetization.

Pre-heating (Motor heating)

The pre-heating function keeps the motor warm and prevents condensation inside the motor by feeding it with DC current when the drive has been stopped. The heating can only be on when the drive is in the stopped state, and starting the drive stops the heating.

When pre-heating is activated and the stop command is given, pre-heating starts immediately if the drive is running below the zero speed limit (see bit 0 in parameter [06.19 Speed control status word](#)). If the drive is running above the zero speed limit, pre-heating is delayed by the time defined by parameter [21.15 Pre-heating time delay](#) to prevent excessive current.

6

The function can be defined to be always active when the drive is stopped or it can be activated by a digital input, fieldbus, timed function or supervision function. For example, with the help of signal supervision function, the heating can be activated by a thermal measurement signal from the motor.

The pre-heating current fed to the motor can be defined as 0...30% of the nominal motor current.

Notes:

- In applications where the motor keeps rotating for a long time after the modulation is stopped, it is recommended to use ramp stop with pre-heating to prevent a sudden pull at the rotor when the pre-heating is activated.
- The heating function requires that the STO circuit is closed or not triggered open.
- The heating function requires that the drive is not faulted.
- The heating function is allowed even if Run permissive signal is missing.
- The heating function is allowed even if one or more Start interlock signals are missing.
- Pre-heating uses DC hold to produce current.

Settings

- **Menu > Primary settings > Motor > Pre-heating**
- Parameters [21.14 Pre-heating input source](#), [21.15 Pre-heating time delay](#) and [21.16 Pre-heating current](#) (page 358).

Pre-magnetization

Pre-magnetization refers to DC magnetization of the motor before start. Depending on the selected start mode ([21.01 Start mode](#) or [21.19 Scalar start mode](#)), pre-magnetization can be applied to guarantee the highest possible breakaway torque,

up to 200% of the nominal torque of the motor. By adjusting the pre-magnetization time ([21.02 Magnetization time](#)), it is possible to synchronize the motor start and, for example, the release of a mechanical brake.

Settings

- Parameters [21.01 Start mode](#), [21.19 Scalar start mode](#), [21.02 Magnetization time](#).

DC hold

The function makes it possible to lock the rotor at (near) zero speed in the middle of normal operation. DC hold is activated by parameter [21.08 DC current control](#). When both the reference and motor speed drop below a certain level (parameter [21.09 DC hold speed](#)), the drive will stop generating sinusoidal current and start to inject DC into the motor. The current is set by parameter [21.10 DC current reference](#). When the reference exceeds parameter [21.09 DC hold speed](#), normal drive operation continues.

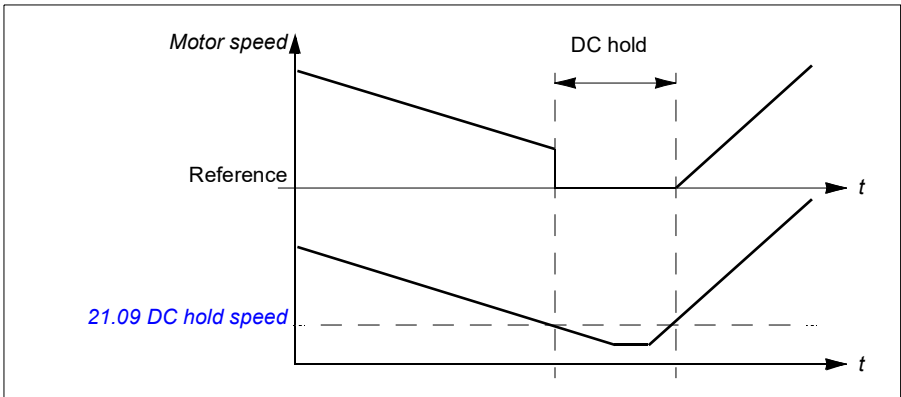

6

Settings

- Parameters [21.08 DC current control](#) and [21.09 DC hold speed](#).

DC brake

This function enables DC injection braking after modulation has stopped for a certain period ([21.11 Post magnetization time](#)). DC injection braking can be used to quickly stop the motor without using a mechanical brake. DC brake is activated by parameter [21.08 DC current control](#). The DC braking current is set by parameter [21.10 DC current reference](#).

Post-magnetization

The function keeps the motor magnetized for a certain period (parameter [21.11 Post magnetization time](#)) after stopping. This is to prevent the machinery from moving under load, for example, before a mechanical brake can be applied. Post-

magnetization is activated by parameter [21.08 DC current control](#). The magnetization current is set by parameter [21.10 DC current reference](#).

Note: Post-magnetization is only available when ramp stop is selected (see parameter [21.03 Stop mode](#)).

Settings

- Parameters [21.03 Stop mode](#) (page 354), [21.08 DC current control](#) and [21.11 Post magnetization time](#).

Switching frequency

The drive has two switching frequencies: reference switching frequency and minimum switching frequency. The drive tries to keep the highest allowed switching frequency (= reference switching frequency) if thermally possible, and then adjusts dynamically between the reference and minimum switching frequencies depending on the drive temperature. When the drive reaches the minimum switching frequency (= lowest allowed switching frequency), it starts to limit output current as the heating up continues.

6

For derating, see chapter *Technical data*, section *Switching frequency derating* in the *Hardware manual* of the drive.

Example 1: If you need to fix the switching frequency to a certain value as with some external filters, for example, with EMC C1 filters (see the *Hardware manual* of the drive), set both the reference and the minimum switching frequency to this value and the drive will retain this switching frequency.

Example 2: If the reference switching frequency is set to 12 kHz and the minimum switching frequency is set to the smallest available value, the drive maintains the highest possible switching frequency to reduce motor noise and only when the drive heats it will decrease the switching frequency. This is useful, for example, in applications where low noise is necessary but higher noise can be tolerated when the full output current is needed.

Settings

- Menu > Primary settings > Motor > Switching frequency**
- Parameters [97.01 Switching frequency reference](#) and [97.02 Minimum switching frequency](#) (page 513).

Motor thermal protection

The control program features two separate motor temperature monitoring functions. The temperature data sources and warning/trip limits can be set up independently for each function.

The motor temperature can be monitored using

- the motor thermal protection model (estimated temperature derived internally inside the drive), or
- sensors installed in the windings. This will result in a more accurate motor model.

Motor thermal protection model

The drive calculates the temperature of the motor on the basis of the following assumptions:

1. When power is applied to the drive for the first time, the motor is assumed to be at ambient temperature (defined by parameter [35.50 Motor ambient temperature](#)). After this, when power is applied to the drive, the motor is assumed to be at the estimated temperature.
2. Motor temperature is calculated using the user-adjustable motor thermal time and motor load curve. The load curve should be adjusted in case the ambient temperature exceeds 30 °C.

Note: The motor thermal model can be used when only one motor is connected to the drive.

Insulation



WARNING! IEC 60664 requires double or reinforced insulation between live parts and the surface of accessible parts of electrical equipment which are either non-conductive or conductive but not connected to the protective earth.

To fulfil this requirement, connect a thermistor to the drive's control terminals using any of these alternatives:

- Separate the thermistor from live parts of the motor with double reinforced insulation.
- Protect all circuits connected to the drive's digital and analog inputs. Protect against contact, and insulate from other low voltage circuits with basic insulation (rated for the same voltage level as the drive's main circuit).
- Use an external thermistor relay. The relay insulation must be rated for the same voltage level as the drive's main circuit.

When CMOD-02 multifunction module is used, it provides sufficient insulation.

Temperature monitoring using PTC sensors

PTC sensors are connected through a CMOD-02 multifunction module (see chapter *Optional I/O extension modules*, section *CMOD-02 multifunction extension module*

(external 24 V AC/DC and isolated PTC interface) in the *Hardware manual* of the drive).

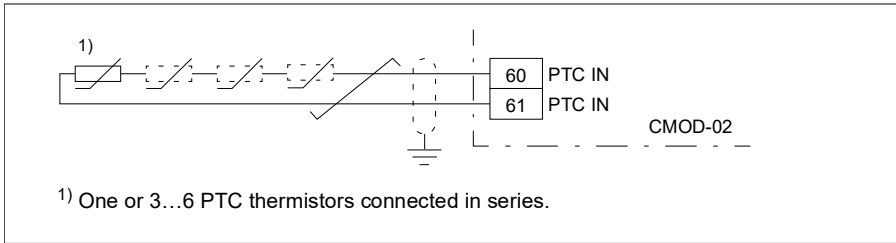

The resistance of the PTC sensor increases when its temperature rises. The increasing resistance of the sensor decreases the voltage at the input, and eventually its state switches from 1 to 0, indicating overtemperature.

1...3 PTC sensors can be connected in series to an analog input and an analog output. The analog output feeds a constant excitation current of 1.6 mA through the sensor. The sensor resistance increases as the motor temperature rises, as does the voltage over the sensor. The temperature measurement function calculates the resistance of the sensor and generates an indication if overtemperature is detected.

6

For wiring of the sensor, see the *Hardware Manual* of the drive.

The figure below shows typical PTC sensor resistance values as a function of temperature.

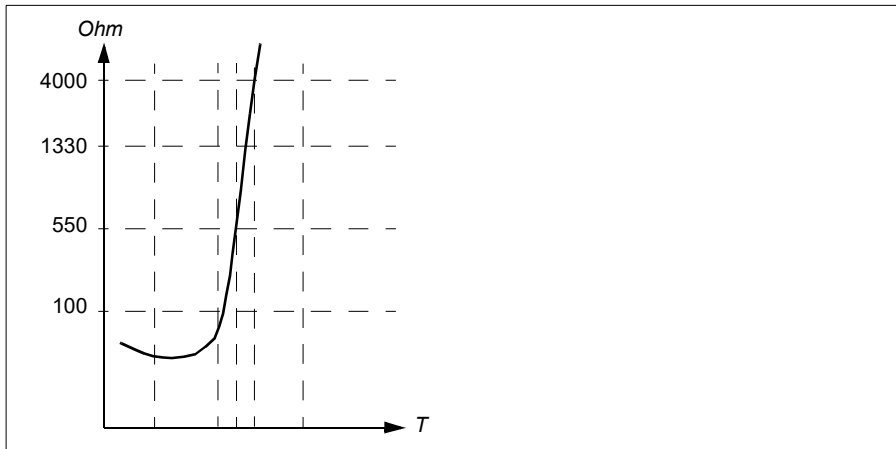

An isolated PTC sensor can also be connected directly to digital input DI6. At the motor end, the cable shield should be grounded through a capacitor. If this is not possible, leave the shield unconnected.

See section [Insulation](#) on page 153.

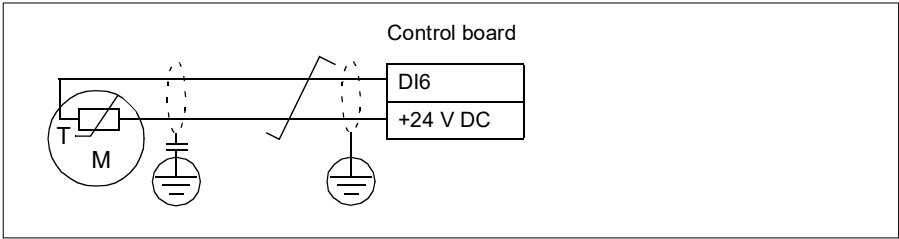

For wiring of the sensor, see the *Hardware manual* of the drive.

Temperature monitoring using Pt100 sensors

1...3 Pt100 sensors can be connected in series to an analog input and an analog output.

The analog output feeds a constant excitation current of 9.1 mA through the sensor. The sensor resistance increases as the motor temperature rises, as does the voltage over the sensor. The temperature measurement function reads the voltage through the analog input and converts it into degrees Celsius.

It is possible to adjust the motor temperature supervision limits and select how the drive reacts when overtemperature is detected.

See section [Insulation](#) on page 153.

For the wiring of the sensor, see [AI1 and AI2 as Pt100, Pt1000, Ni1000, KTY83 and KTY84 sensor inputs \(X1\)](#) on page 158.

Temperature monitoring using Pt1000 sensors

1...3 Pt1000 sensors can be connected in series to an analog input and an analog output.

The analog output feeds a constant excitation current of 0.1 mA through the sensor. The sensor resistance increases as the motor temperature rises, as does the voltage over the sensor. The temperature measurement function reads the voltage through the analog input and converts it into degrees Celsius.

See section [Insulation](#) on page 153.

For the wiring of the sensor, see [AI1 and AI2 as Pt100, Pt1000, Ni1000, KTY83 and KTY84 sensor inputs \(X1\)](#) on page 158.

Temperature monitoring using Ni1000 sensors

One Ni1000 sensor can be connected to an analog input and an analog output on the control unit.

The analog output feeds a constant excitation current of 9.1 mA through the sensor. The sensor resistance increases as the motor temperature rises, as does the voltage

over the sensor. Resistance at 100 degrees Celsius is 1618 ohm, and the rate of change is 6180 ppm / degrees Celsius. The temperature measurement function reads the voltage through the analog input and converts it into degrees Celsius.

See section *Insulation* on page 153.

For the wiring of the sensor, see section *A11 and A12 as Pt100, Pt1000, Ni1000, KTY83 and KTY84 sensor inputs (X1)* on page 158.

Temperature monitoring using KTY84 sensors

One KTY84 sensor can be connected to an analog input and an analog output on the control unit.

The analog output feeds a constant excitation current of 2.0 mA through the sensor. The sensor resistance increases as the motor temperature rises, as does the voltage over the sensor. The temperature measurement function reads the voltage through the analog input and converts it into degrees Celsius.

The figure and table on page 157 show typical KTY84 sensor resistance values as a function of the motor operating temperature.

See section *Insulation* on page 153.

For the wiring of the sensor, see section *A11 and A12 as Pt100, Pt1000, Ni1000, KTY83 and KTY84 sensor inputs (X1)* on page 158.

Temperature monitoring using KTY83 sensors

One KTY83 sensor can be connected to an analog input and an analog output on the control unit.

The analog output feeds a constant excitation current of 1.0 mA through the sensor. The sensor resistance increases as the motor temperature rises, as does the voltage over the sensor. The temperature measurement function reads the voltage through the analog input and converts it into degrees Celsius.

The figure and table below show typical KTY83 sensor resistance values as a function of the motor operating temperature.

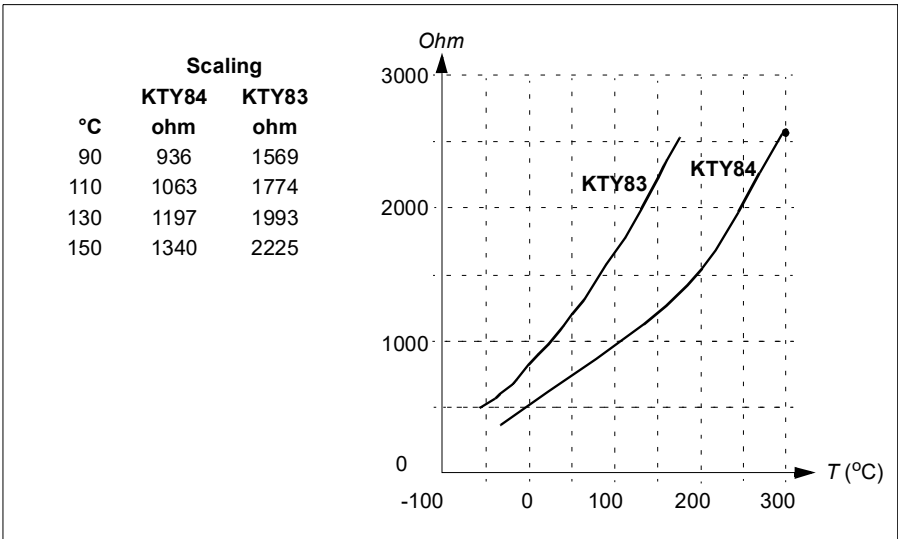

It is possible to adjust the motor temperature supervision limits and select how the drive reacts when overtemperature is detected.

See section [Insulation](#) on page [153](#).

For the wiring of the sensor, see section [AI1 and AI2 as Pt100, Pt1000, Ni1000, KTY83 and KTY84 sensor inputs \(X1\)](#) on page [158](#).

AI1 and AI2 as Pt100, Pt1000, Ni1000, KTY83 and KTY84 sensor inputs (X1)

One, two or three Pt100 sensors; one, two or three Pt1000 sensors; or one Ni1000, KTY83 or KTY84 sensor for motor temperature measurement can be connected between an analog input and output as shown below. Do not connect both ends of the cable shields directly to ground. If a capacitor cannot be used at one end, leave that end of the shield unconnected.

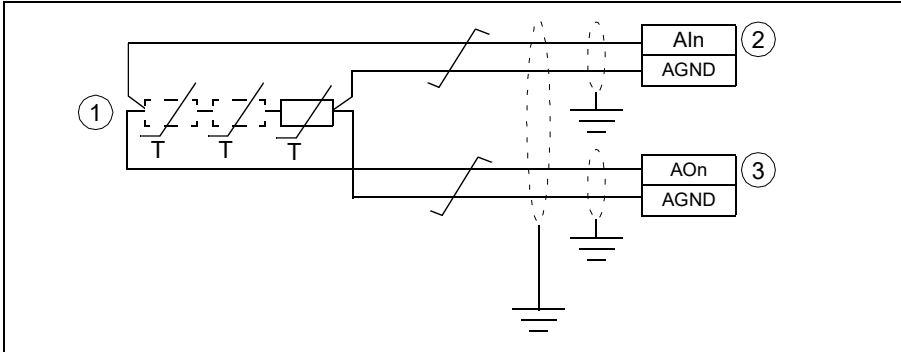

6

1	1...3 × (Pt100 or Pt1000) or 1 × (Ni1000 or KTY83 or KTY84)
2	Select the input type to voltage for analog input AI1 or AI2 with parameters. Set the appropriate analog input unit to V (volt) in parameter group 12 Standard AI .
3	Select the excitation mode in parameter group 13 Standard AO .

⚠ WARNING! As the inputs pictured above are not insulated according to IEC 60664, the connection of the motor temperature sensor requires double or reinforced insulation between motor live parts and the sensor. If the assembly does not fulfill the requirement, the I/O board terminals must be protected against contact and must not be connected to other equipment or the temperature sensor must be isolated from the I/O terminals.

Temperature monitoring using thermistor relays

A normally closed or a normally open thermistor relay can be connected to digital input DI6.

See section [Insulation](#) on page 153.

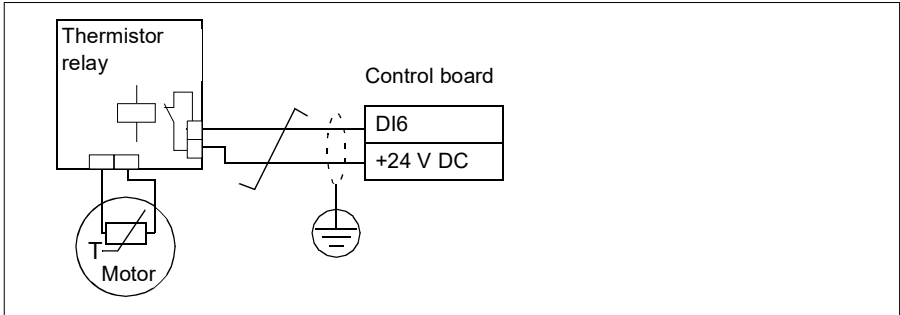

Settings

- **Menu > Primary settings > Motor > Thermal protection estimated**
- **Menu > Primary settings > Motor > Thermal protection measured**
- Parameter group [35 Motor thermal protection](#) (page 418).

Motor overload protection

This section describes motor overload protection without using motor thermal protection model, either with estimated or measured temperature. For protection with the motor thermal protection model, see section [Motor thermal protection](#) on page 152.

Motor overload protection is required and specified by multiple standards including the US National Electric Code (NEC), UL 508C and the common UL\IEC 61800-5-1 standard in conjunction with IEC 60947-4-1. The standards allow for motor overload protection without external temperature sensors.

The protection feature allows the user to specify the class of operation in the same manner as the overload relays are specified in standards IEC 60947-4-1 and NEMA ICS 2.

Motor overload protection requires that you specify a motor current tripping level. This is defined by a curve using parameters [35.51 Motor load curve](#), [35.52 Zero speed load](#) and [35.53 Break point](#). The tripping level is the motor current at which the overload protection will ultimately trip if the motor current remains at this level continuously.

The motor overload class (class of operation), parameter [35.57 Motor overload class](#), is given as the time required for the overload relay to trip when operating at 7.2 times the tripping level in the case of IEC 60947-4-1 and 6 times the tripping level in the case of NEMA ICS 2. The standards also specify the time to trip for current levels

between the tripping level and the 6 times tripping level. The drive satisfies the IEC standard and NEMA standard trip times.

Using class 20 satisfies the UL 508C requirements.

The motor overload algorithm monitors the squared ratio (motor current / tripping level)² and accumulates this over time. This is sometimes referred to as I^2t protection. The accumulated value is shown with parameter [35.05 Motor overload level](#).

You can define with parameter [35.56 Motor overload action](#) that when [35.05 Motor overload level](#) reaches 88%, a motor overload warning will be generated, and when it reaches 100%, the drive will trip on the motor overload fault. The rate at which this internal value is increased depends on the actual current, tripping level current and overload class selected.

Parameters [35.51 Motor load curve](#), [35.52 Zero speed load](#) and [35.53 Break point](#) serve a dual purpose. They determine the load curve for temperature estimate when using motor thermal protection model as well as specify the overload tripping level.

6

Motor overload protection fulfills standard IEC/EN 61800-5-1 ed. 2.1 requirements for thermal memory retention and speed sensitivity. The motor overload state is retained over power down. Speed dependency is set by parameters [35.51 Motor load curve](#), [35.52 Zero speed load](#) and [35.53 Break point](#).

Settings

- Parameters common to motor thermal protection and motor overload protection: [35.51 Motor load curve](#) (page 428), [35.52 Zero speed load](#) (page 428) and [35.53 Break point](#) (page 428).
 - Parameters specific to motor overload protection: [35.05 Motor overload level](#) (page 419), [35.56 Motor overload action](#) (page 430) and [35.57 Motor overload class](#) (page 430).
-

Speed control performance figures

The table below shows typical performance figures for speed control.

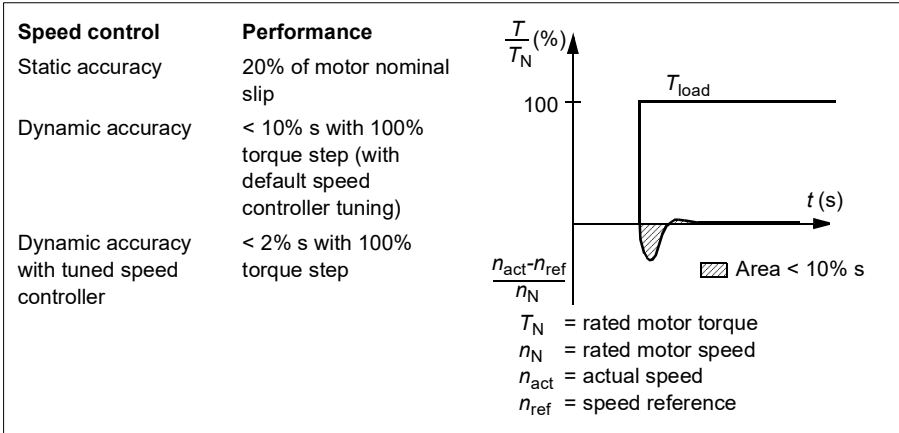

Torque control performance figures

The drive can perform precise torque control in vector control mode without any speed feedback from the motor shaft. The table below shows typical performance figures for vector control.

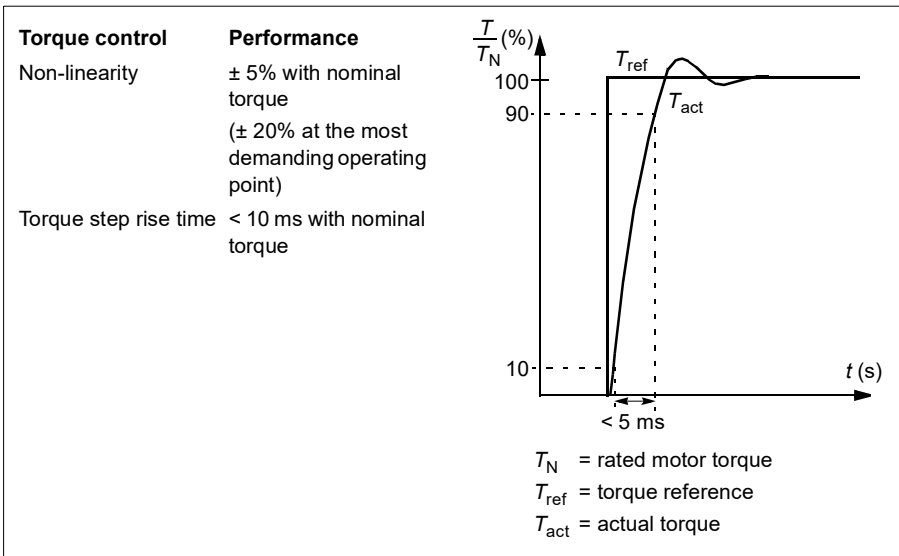

Motor potentiometer

The Motor potentiometer is, in effect, a counter whose value can be adjusted up and down using two digital signals selected by parameters [22.73 Motor potentiometer up source](#) and [22.74 Motor potentiometer down source](#).

When the Motor potentiometer is enabled by [22.71 Motor potentiometer function](#), the counter assumes the value set by [22.72 Motor potentiometer initial value](#). Depending on the mode selected in [22.71](#), the counter value is either retained or reset over a power cycle.

The change rate is defined in [22.75 Motor potentiometer ramp time](#) as the time it would take for the value to change from the minimum ([22.76 Motor potentiometer min value](#)) to the maximum ([22.77 Motor potentiometer max value](#)) or vice versa. If the up and down signals are simultaneously on, the counter value does not change.

The output of the Motor potentiometer is shown by [22.80 Motor potentiometer ref act](#), which can directly be set as the reference source in the main selector parameters, or used as an input by other source selector parameters, both in scalar and vector control.

6

The following example shows the behavior of the Motor potentiometer counter value.

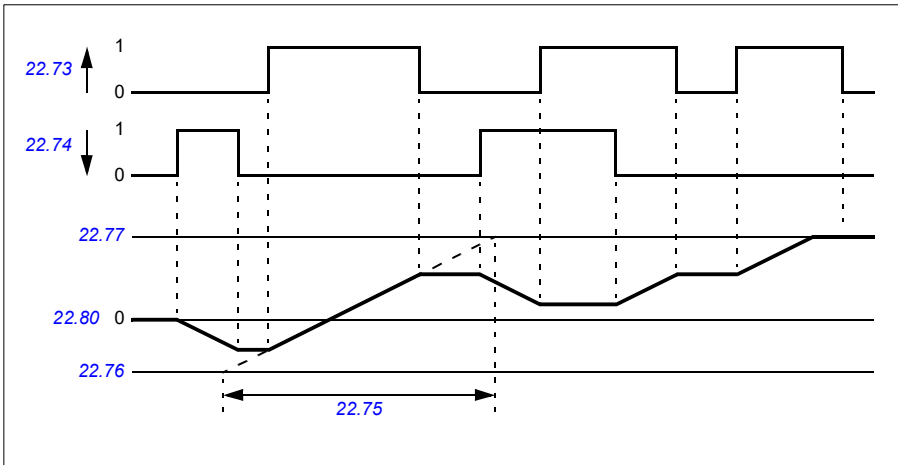

Parameters [22.73 Motor potentiometer up source](#) and [22.74 Motor potentiometer down source](#) control speed or frequency from zero to maximum speed or frequency.

The running direction can be changed with parameter [20.04 Ext1 in2 source](#). See the following example.

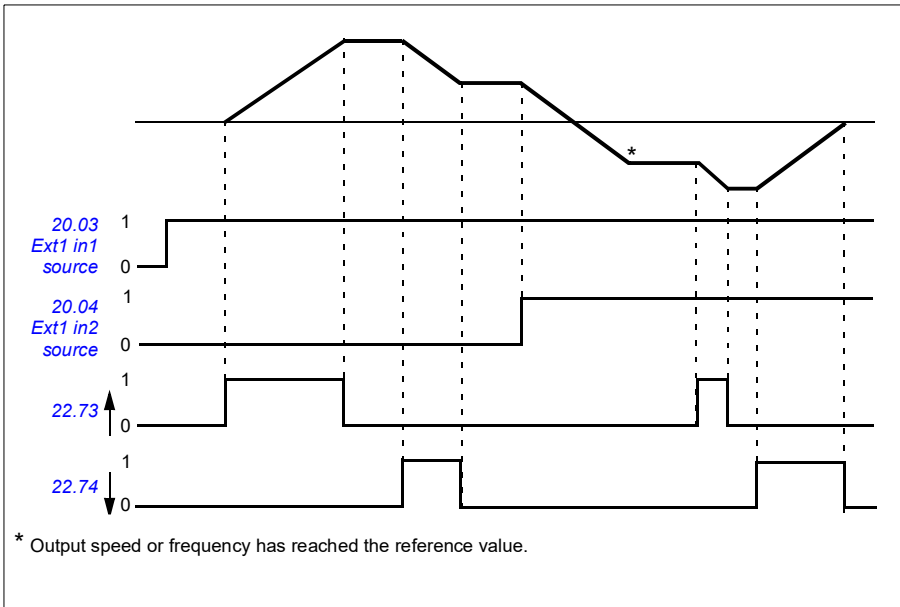

Settings

- Parameters [22.71 Motor potentiometer function...](#)[22.80 Motor potentiometer ref act](#) (page 368).

Speed controller autotune

You can adjust the speed controller of the drive automatically with the autotune function. Autotuning is based on an estimation of the mechanical time constant (inertia) of the motor and machine.

The autotune routine will run the motor through a series of acceleration/deceleration cycles. The number of cycles can be adjusted by parameter [25.40 Auto tune repeat times](#). Higher values will produce more accurate results, especially if the difference between initial and maximum speeds is small.

The maximum torque reference used during autotuning will be the initial torque (i.e. torque when the routine is activated) plus the value of parameter [25.38 Auto tune torque step](#), unless limited by the maximum torque limit (parameter group [30 Limits](#)) or the nominal motor torque ([99 Motor data](#)). The calculated maximum speed during the routine is the initial speed (i.e. speed when the routine is activated) + the value of parameter [25.39 Auto tune speed step](#), unless limited by parameter [30.12 Maximum speed](#) or [99.09 Motor nominal speed](#).

The diagram below shows the behavior of speed and torque during the autotune routine. In this example, parameter [25.40 Auto tune repeat times](#) is set to 2.

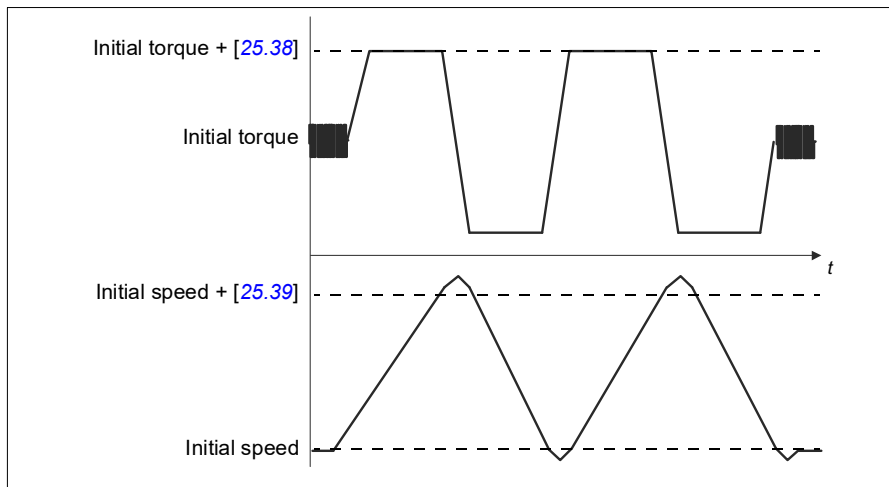

6

Notes

- If the drive cannot produce the requested braking power during the routine, the results will be based on the acceleration stages only, and will not be as accurate as with full braking power.
- The motor will exceed the calculated maximum speed slightly at the end of each acceleration stage.

Before activating the autotune routine

The prerequisites for performing the autotune routine are the following:

- The motor identification run (ID run) has been successfully completed
- Speed and torque limits (parameter group [30 Limits](#)) have been set
- The speed feedback has been monitored for noise, vibrations and other disturbances caused by the mechanics of the system, and speed error filtering ([24 Speed reference conditioning](#)) and zero speed (parameters [21.06](#) and [21.07](#)) have been set to eliminate these disturbances.
- The drive has been started and is running in speed control mode.

After these conditions have been fulfilled, autotuning can be activated by parameter [25.33 Speed controller auto tune](#) (or the signal source selected by it).

Autotune modes

Autotuning can be performed in three different ways depending on the setting of parameter [25.34 Auto tune control preset](#). Selections *Smooth*, *Normal* and *Tight* define how the drive torque reference should react to a speed reference step after

tuning. The selection *Smooth* will produce a slow but robust response; *Tight* will produce a fast response but possibly too high gain values for some applications. The figure below shows speed responses at a speed reference step (typically 1...20%).

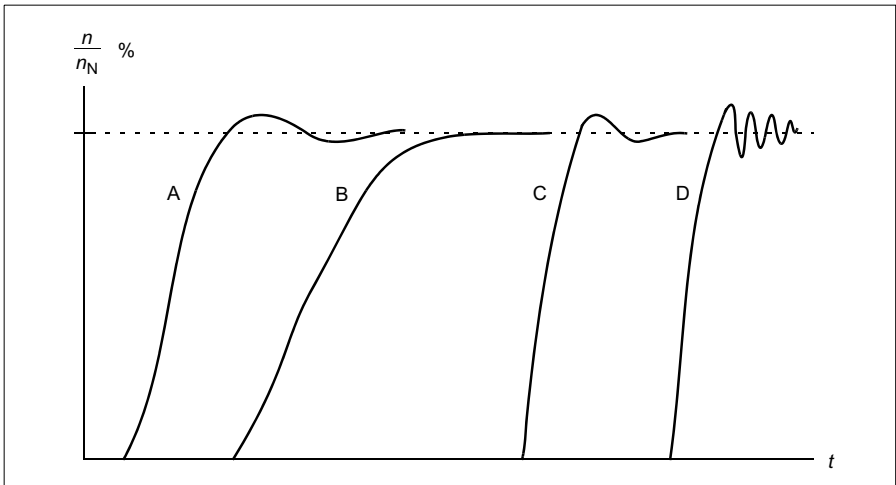

A: Undercompensated

B: Normally tuned (autotuning)

C: Normally tuned (manually). Better dynamic performance than with B

D: Overcompensated speed controller

Autotune results

At the end of a successful autotune routine, its results are automatically transferred into the following parameters:

- [25.02 Speed proportional gain](#) (proportional gain of the speed controller)
- [25.03 Speed integration time](#) (integration time of the speed controller)
- [25.37 Mechanical time constant](#) (mechanical time constant of the motor and machine).

Nevertheless, it is still possible to manually adjust the controller gain, integration time and derivation time.

The figure below is a simplified block diagram of the speed controller. The controller output is the reference for the torque controller.

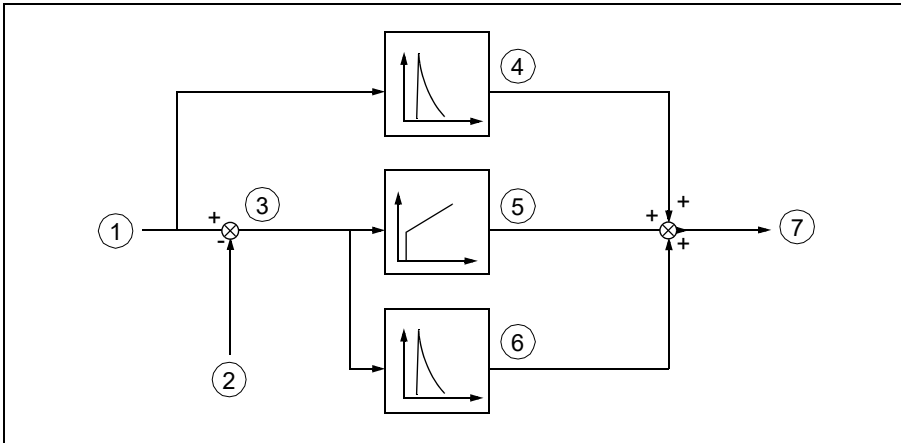

6

1	Speed reference
2	Actual speed
3	Error value
4	Derivative acceleration compensation
5	Proportional, integral
6	Derivative
7	Torque reference

Warning indications

A warning message, *AF90 Speed controller autotuning*, will be generated if the autotune routine does not complete successfully. See chapter *Fault tracing* on page 187 for further information.

Settings

- Parameters *25.33 Speed controller auto tune...25.40 Auto tune repeat times*
- Event: *AF90 Speed controller autotuning*.

DC voltage control

Overvoltage control

Overvoltage control of the intermediate DC link is typically needed when the motor is in generating mode. The motor can generate when it decelerates or when the load overhauls the motor shaft, causing the shaft to turn faster than the applied speed or frequency. To prevent the DC voltage from exceeding the overvoltage control limit, the overvoltage controller automatically decreases the generating torque when the limit is reached. The overvoltage controller also increases any programmed deceleration times if the limit is reached; to achieve shorter deceleration times, a brake chopper and resistor may be required.

Undervoltage control (power loss ride-through)

If the incoming supply voltage is cut off, the drive will continue to operate by utilizing the kinetic energy of the rotating motor. The drive will be fully operational as long as the motor rotates and generates energy to the drive. The drive can continue operation after the break if the main contactor (if present) remained closed.

Note: Units equipped with a main contactor must be equipped with a hold circuit (for example, UPS) to keep the contactor control circuit closed during a short supply break.

6

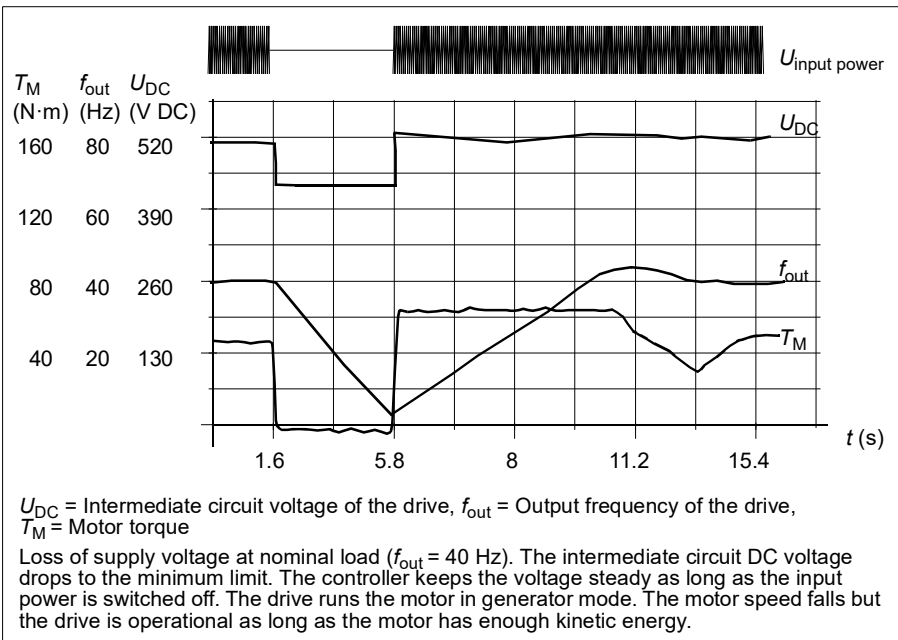

Implementing the undervoltage control (power loss ride-through)

Implement the undervoltage control function as follows:

- Check that the undervoltage control function of the drive is enabled with parameter [30.31 Undervoltage control](#).
- Parameter [21.01 Start mode](#) must be set to *Automatic* (in vector mode) or parameter [21.19 Scalar start mode](#) to *Automatic* (in scalar mode) to make flying start (starting into a rotating motor) possible.

If the installation is equipped with a main contactor, prevent its tripping at the input power break. For example, use a time delay relay (hold) in the contactor control circuit.



WARNING! Make sure that the flying restart of the motor will not cause any danger. If you are in doubt, do not implement the undervoltage control function.

Automatic restart

6

It is possible to restart the drive automatically after a short (max. 10 seconds) power supply failure by using the Automatic restart function, provided that the drive is allowed to run for 10 seconds without the cooling fans operating.

When enabled, the function takes the following actions upon a supply failure to a successful restart:

- The undervoltage fault is suppressed (but a warning is generated).
- Modulation and cooling is stopped to conserve any remaining energy.
- DC circuit pre-charging is enabled.

If the DC voltage is restored before the expiration of the period defined by parameter [21.18 Auto restart time](#) and the start signal is still on, normal operation will continue. However, if the DC voltage remains too low at that point, the drive trips on a fault, [3220 DC link undervoltage](#).

If parameter [21.34 Force auto restart](#) is set to *Enable*, the drive never trips on the undervoltage fault and the start signal is on forever. When the DC voltage is restored, the normal operation continues.



WARNING! Before you activate the function, make sure that no dangerous situations can occur. The function restarts the drive automatically and continues operation after a supply break.

■ Voltage control and trip limits

The control and trip limits of the intermediate DC voltage regulator are relative to the supply voltage as well as drive/inverter type. The DC voltage (U_{DC}) is approximately

1.41 times the line-to-line supply voltage, and is displayed by parameter [01.11 DC voltage](#).

The system calculates the necessary drive DC limits from parameters [95.01 Supply voltage](#) and [95.02 Adaptive voltage limits](#).

DC voltage levels for drive types -01 and -04

The following table shows the values of selected DC voltage levels. Note that the absolute voltages vary according to the drive/inverter type and AC supply voltage range.

Adaptive voltage limit enabled by parameter [95.02 Adaptive voltage limits](#)

DC voltage level [V] See 95.01 Supply voltage .	95.01 Supply voltage		
	AC supply voltage range [V] 380...415	AC supply voltage range [V] 440...480	Automatic / Not selected
Overshoot fault limit	842	842	842
Overshoot control limit	779	779	779
Internal brake chopper start limit	779	779	779
Internal brake chopper stop limit	759	759	759
Overshoot warning limit	745	745	745
Undervoltage warning limit	$0.85 \times 1.41 \times \text{par } 95.03$ value	$0.85 \times 1.41 \times \text{par } 95.03$ value	$0.85 \times 1.41 \times \text{par } 95.03$ value
Undervoltage control limit	$0.78 \times 1.41 \times \text{par } 95.03$ value	$0.78 \times 1.41 \times \text{par } 95.03$ value	$0.78 \times 1.41 \times \text{par } 95.03$ value
Charging relay closing limit / charging deactivation	$0.78 \times 1.41 \times \text{par } 95.03$ value	$0.78 \times 1.41 \times \text{par } 95.03$ value	$0.78 \times 1.41 \times \text{par } 95.03$ value
Charging relay opening limit / charging activation	$0.73 \times 1.41 \times \text{par } 95.03$ value	$0.73 \times 1.41 \times \text{par } 95.03$ value	$0.73 \times 1.41 \times \text{par } 95.03$ value
DC voltage at upper bound of supply voltage range (U_{DCmax})	560	648	(variable)
DC voltage at lower bound of supply voltage range (U_{DCmin})	513	594	(variable)
Standby limit ³⁾	$0.73 \times 1.41 \times \text{par } 95.03$ value	$0.3 \times 1.41 \times \text{par } 95.03$ value	$0.73 \times 1.41 \times \text{par } 95.03$ value

Note: Parameter [95.03 Estimated AC supply voltage](#) is the estimated AC supply voltage while powering up the drive and it will not be continuously updated during run time.

Adaptive voltage limit disabled by parameter [95.02 Adaptive voltage limits](#)

DC voltage level [V] See 95.01 Supply voltage .	95.01 Supply Voltage			
	AC supply voltage range [V AC] 380...415	AC supply voltage range [V AC] 440...480	Automatic / Not selected	
			if 95.03 < 456 V AC	if 95.03 > 456 V AC
Overvoltage fault limit	842	842	842	842
Overvoltage control limit	779	779	779	779
Internal brake chopper start limit	779	779	779	779
Internal brake chopper stop limit	759	759	759	759
Overvoltage warning limit	745	745	745	745
Undervoltage warning limit	$0.85 \times 1.35 \times 380 = 436$	$0.85 \times 1.35 \times 440 = 504$	$0.85 \times 1.35 \times 380 = 436$	$0.85 \times 1.35 \times 440 = 505$
Undervoltage control limit	$0.78 \times 1.35 \times 380 = 400$	$0.78 \times 1.35 \times 440 = 463$	$0.78 \times 1.35 \times 380 = 400$	$0.78 \times 1.35 \times 440 = 463$
Charging relay closing limit / charging deactivation	$0.78 \times 1.35 \times 380 = 400$	$0.78 \times 1.35 \times 440 = 463$	$0.78 \times 1.35 \times 380 = 400$	$0.78 \times 1.35 \times 440 = 463$
Charging relay opening limit / charging activation	$0.73 \times 1.35 \times 380 = 374$	$0.73 \times 1.35 \times 440 = 433$	$0.73 \times 1.35 \times 380 = 374$	$0.73 \times 1.35 \times 440 = 433$
DC voltage at upper bound of supply voltage range (U_{DCmax})	560	648	(variable)	(variable)
DC voltage at lower bound of supply voltage range (U_{DCmin})	513	594	(variable)	(variable)
Standby limit	$0.73 \times 1.35 \times 380 = 374$	$0.73 \times 1.35 \times 440 = 433$	$0.73 \times 1.35 \times 380 = 374$	$0.73 \times 1.35 \times 440 = 433$
Undervoltage fault limit ¹⁾	$0.73 \times 1.35 \times 380 = 374$	$0.73 \times 1.35 \times 440 = 433$	$0.73 \times 1.35 \times 380 = 374$	$0.73 \times 1.35 \times 440 = 433$

¹⁾ See section [Triggering the undervoltage fault](#) on page [172](#).

DC voltage levels for drive types --31/34

All levels are relative to the supply voltage range selected in parameter [95.01 Supply voltage](#). The following table shows the values of selected DC voltage levels in volts and in percent of U_{DCmax} (the DC voltage at the upper bound of the supply voltage range).

Level [V DC (% of U_{DCmax})]	Supply voltage range [V AC] (see 95.01 Supply voltage)					
	208...240	380...415	440...480	500	525...600	660...690
Overvoltage fault limit	489/440*	800	878	880	1113	1218
Overvoltage control limit	405 (125)	700 (125)	810 (125)	810 (120)	1013 (125)	1167 (125)
Internal brake chopper at 100% pulse width	403 (124)	697 (124)	806 (124)	806 (119)	1008 (124)	1159 (124)
Internal brake chopper at 0% pulse width	375 (116)	648 (116)	749 (116)	780 (116)	936 (116)	1077 (116)
Overvoltage warning limit	373 (115)	644 (115)	745 (115)	776 (115)	932 (115)	1071 (115)
U_{DCmax} = DC voltage at upper bound of supply voltage range	324 (100)	560 (100)	648 (100)	675 (100)	810 (100)	932 (100)
DC voltage at lower bound of supply voltage range	281	513	594	675	709	891
Undervoltage control and warning limit	239 (85)	436 (85)	505 (85)	574 (85)	602 (85)	757 (85)
Charging activation/standby limit	225 (80)	410 (80)	475 (80)	540 (80)	567 (80)	713 (80)
Undervoltage fault limit	168 (60)	308 (60)	356 (60)	405 (60)	425 (60)	535 (60)

*489 V with frames R1...R3, 440 V with frames R4...R8.

Triggering the undervoltage warning

The undervoltage warning [A3A2](#) is triggered if one of below conditions is active:

- If the DC link voltage goes below the undervoltage warning limit when the drive is not modulating.
- If the DC link voltage goes below the standby limit when the drive is modulating, and auto restart is enabled (that is, parameter [21.18 Auto restart time](#) > 0.0 s). The warning will continue to appear if the actual DC link voltage is continuously below the standby limit and until the auto restart time has elapsed. The drive control board must be externally powered by 24 VDC to have this functionality, otherwise the control board may be switched off if the voltage goes below the hardware limit.

Triggering the undervoltage fault

The undervoltage fault [3220](#) is triggered if the drive is modulating and one of the below conditions is active:

- If the DC link voltage goes below the undervoltage trip limit and auto restart is not enabled (that is, parameter [21.18 Auto restart time](#) = 0.0 s).
- If the DC link voltage goes below the undervoltage trip limit and auto restart is enabled (that is, parameter [21.18 Auto restart time](#) > 0.0 s), then undervoltage trip will occur if only the DC link voltage is continuously below the undervoltage trip limit and after auto restart time has elapsed. Control board of the drive must be externally powered by 24 VDC source to have this functionality. Otherwise the control board may be switched off, just showing an undervoltage warning.

Settings

- Parameters [01.11 DC voltage](#) (page [288](#)), [30.30 Overvoltage control](#) (page [388](#)), [30.31 Undervoltage control](#) (page [388](#)), [95.01 Supply voltage](#) (page [513](#)) and [95.02 Adaptive voltage limits](#) (page [513](#)).
- Warning [A3A2 DC link undervoltage](#) (page [191](#)) and fault [3220 DC link undervoltage](#) (page [206](#)).

6

■ Brake chopper

A brake chopper can be used to handle the energy generated by a decelerating motor. When the DC voltage rises high enough, the chopper connects the DC circuit to an external brake resistor. The chopper operates on the pulse width modulation principle.

The internal brake choppers in the drive (in frames R1...R3) start conducting when the DC link voltage reaches approximately $1.15 \times U_{DCmax}$. 100% maximum pulse width is reached at approximately $1.2 \times U_{DCmax}$. (U_{DCmax} is the DC voltage corresponding to the maximum of the AC supply voltage range.) For information on external brake choppers, refer to their documentation.

Note: Overvoltage control needs to be disabled for the chopper to operate.

Settings

- Parameter [01.11 DC voltage](#) (page [288](#))
- Parameter group [43 Brake chopper](#) (page [456](#)).

Supervisory

Signal supervision

Six signals can be selected to be supervised by this function. Whenever a supervised signal exceeds or falls below predefined limits, a bit in [32.01 Supervision status](#) is activated, and a warning or fault generated.

The supervised signal is low-pass filtered.

Settings

- Parameter group [32 Supervision](#) (page [403](#)).

User load curve (Condition monitoring)

The User load curve provides a supervisory function that monitors an input signal as a function of frequency or speed, and load. It shows the status of the monitored signal and can give a warning or fault based on the violation of a user defined profile.

The user load curve consists of an overload and an underload curve, or just one of them. Each curve is formed by five points that represent the monitored signal as a function of frequency or speed.

In the example below, the user load curve is constructed from the motor nominal torque to which a 10% margin is added and subtracted. The margin curves define a working envelope for the motor so that excursions outside the envelope can be supervised, timed and detected.

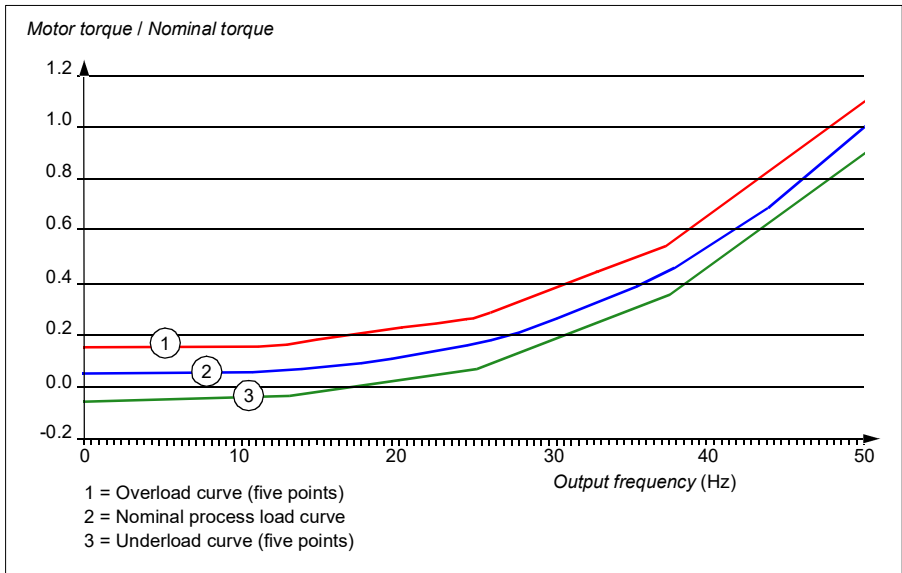

An overload warning and/or fault can be set to occur if the monitored signal stays continuously over the overload curve for a defined time. An underload warning and/or fault can be set to occur if the monitored signal stays continuously under the underload for a defined time.

Overload can be, for example, used to monitor for a stuck pump or dirty impeller.

Underload can be, for example, used to monitor for load dropping and for a blockage in pump inlet (suction side).

The load curve can be used as a trigger for the pump cleaning function. (Underload = blocked inlet on the pump, Overload = blockage in the pump impeller or output of the pump).

The user load curve can also, over a longer time period, be used to demonstrate when the efficiency of a pump system may be dropping so it can be used along with a maintenance trigger.

Settings

- Parameter group [37 User load curve](#) (page [433](#)).

Energy efficiency

■ Energy optimization

The function optimizes the motor flux so that total energy consumption and motor noise level are reduced when the drive operates below the nominal load. The total efficiency (motor and drive) can be improved by 1...20% depending on load torque and speed. Energy optimization is enabled by default.

Note: With permanent magnet and synchronous reluctance motors, energy optimization is always enabled.

Settings

- **Menu > Energy efficiency**
- Parameter [45.11 Energy optimizer](#) (page [459](#)).

■ Energy saving calculators

This feature consists of the following functionalities:

- An energy optimizer that adjusts the motor flux in such a way that the total system efficiency is maximized
- A counter that monitors used and saved energy by the motor and displays them in kWh, currency or volume of CO₂ emissions, and
- A load analyzer showing the load profile of the drive (see separate section on page [176](#)).

In addition, there are counters that show energy consumption in kWh of the current and previous hour as well as the current and previous day.

The amount of energy that has passed through the drive (in either direction) is counted and shown as full GWh, MWh and kWh. The cumulative energy is also shown as full kWh. All these counters are resettable.

Note: The accuracy of the energy savings calculation is directly dependent on the accuracy of the reference motor power given in parameter [45.19 Comparison power](#).

Settings

- **Menu > Energy efficiency**
- Parameter group [45 Energy efficiency](#) (page [457](#))
- Parameters [01.50 Current hour kWh](#), [01.51 Previous hour kWh](#), [01.52 Current day kWh](#) and [01.53 Previous day kWh](#) (on page [289](#))
- Parameters [01.55 Inverter GWh counter \(resettable\)](#), [01.56 Inverter MWh counter \(resettable\)](#), [01.57 Inverter kWh counter \(resettable\)](#) and [01.58 Cumulative inverter energy \(resettable\)](#) (on page [290](#)).

Load analyzer

Peak value logger

The user can select a signal to be monitored by a peak value logger. The logger records the peak value of the signal along with the time the peak occurred, as well as motor current, DC voltage and motor speed at the time of the peak. The peak value is sampled at 2 ms intervals.

Amplitude loggers

The control program has two amplitude loggers.

For amplitude logger 2, the user can select a signal to be sampled at 200 ms intervals, and specify a value that corresponds to 100%. The collected samples are sorted into 10 read-only parameters according to their amplitude. Each parameter represents an amplitude range 10 age points wide, and displays the age of the collected samples that have fallen within that range.

You can view this graphically with the assistant control panel or the Drive composer PC tool.

6

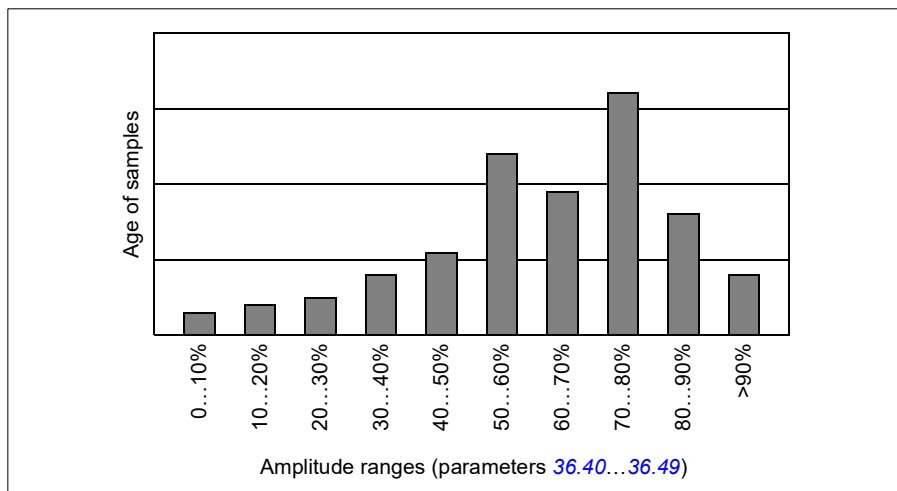

Amplitude logger 1 is fixed to monitor motor current, and cannot be reset. With amplitude logger 1, 100% corresponds to the maximum output current of the drive (I_{max}), which is listed in the *Hardware manual* of the drive. The measured current is logged continuously. The distribution of samples is shown by parameters [36.20...36.29](#).

Settings

- **Menu > Diagnostics > Load profile**
- Parameter group [36 Load analyzer](#) (page [430](#)).

User parameter sets

The drive supports four user parameter sets that can be saved to the permanent memory and recalled using drive parameters. It is possible to use digital inputs to switch between user parameter sets.

A user parameter set contains all editable values in parameter groups 10...99 except

- forced I/O values such as parameters [10.03 DI force selection](#) and [10.04 DI forced data](#)
- I/O extension module settings (group 15)
- data storage parameters (group 47)
- fieldbus communication enable parameter ([50.01 FBA A enable](#))
- other fieldbus communication settings (groups 51...53 and 58)
- some hardware settings in group [95 HW configuration](#) (for example parameter [95.01 Supply voltage](#))
- user set selection parameters [96.11...96.13](#).

As the motor settings are included in the user parameter sets, make sure the settings correspond to the motor used in the application before recalling a user set. In an application where different motors are used with the drive, the motor ID run needs to be performed with each motor and the results saved to different user sets. The appropriate set can then be recalled when the motor is switched.

If no parameter sets have been saved, attempting to load a set will create all sets from the currently active parameter settings.

Switching between sets is only possible with the drive stopped.

Settings

- **Menu > Primary settings > Advanced functions > User sets**
- Parameters [96.10...96.13](#) (page [520](#)).

System safety and protections

■ Fixed/Standard protections

Overcurrent

If the output current exceeds the internal overcurrent limit, the IGBTs are shut down immediately to protect the drive.

DC overvoltage

See section [Overvoltage control](#) on page 167.

DC undervoltage

See section [Undervoltage control \(power loss ride-through\)](#) on page 167.

Drive temperature

If the temperature rises high enough, the drive first starts to limit the switching frequency and then the current to protect itself. If it is still keeps heating up, for example, because of a fan failure, an overtemperature fault is generated.

Short circuit

In case of a short circuit, the IGBTs are shut down immediately to protect the drive.

■ Programmable protection functions

Motor phase loss detection (parameter 31.19)

The parameter selects how the drive reacts whenever a motor phase loss is detected.

Supply phase loss detection (parameter 31.21)

The parameter selects how the drive reacts whenever a supply phase loss is detected.

Safe torque off detection (parameter 31.22)

The drive monitors the status of the Safe torque off input, and this parameter selects which indications are given when the signals are lost. (The parameter does not affect the operation of the Safe torque off function itself.) For more information on the Safe torque off function, see chapter *Planning the electrical installation*, section *Implementing the Safe torque off function* in the *Hardware manual* of the drive.

Swapped supply and motor cabling (parameter 31.23)

The drive can detect if the supply and motor cables have accidentally been swapped (for example, if the supply is connected to the motor connection of the drive). The parameter selects if a fault is generated or not.

Stall protection (parameters 31.24...31.28)

The drive protects the motor in a stall situation. It is possible to adjust the supervision limits (current, frequency and time) and choose how the drive reacts to a motor stall condition.

Overspeed protection (parameter 31.30...31.31)

The user can set overspeed and overfrequency limits by specifying a margin that is added to the currently-used maximum and minimum speed or frequency limits.

Local control loss detection (parameter 49.05)

The parameter selects how the drive reacts to a control panel or PC tool communication break.

AI supervision (parameters 12.03...12.04)

The parameters select how the drive reacts when an analog input signal moves out of the minimum and/or maximum limits specified for the input. This can be due to broken I/O wiring or sensor.

■ Emergency stop

The emergency stop signal is connected to the input selected by parameter [21.05 Emergency stop source](#). An emergency stop can also be generated through fieldbus (parameter [06.01 Main control word](#), bits 0...2).

The mode of the emergency stop is selected by parameter [21.04 Emergency stop mode](#). The following modes are available:

- Off1: Stop along the standard deceleration ramp defined for the particular reference type in use
- Off2: Stop by coasting
- Off3: Stop by the emergency stop ramp defined by parameter [23.23 Emergency stop time](#).

With Off1 or Off3 emergency stop modes, the ramp-down of the motor speed can be supervised by parameters [31.32 Emergency ramp supervision](#) and [31.33 Emergency ramp supervision delay](#).

Notes:

- The installer of the equipment is responsible for installing the emergency stop devices and all additional devices needed for the emergency stop function to fulfill the required emergency stop categories. For more information, contact your local ABB representative.
- After an emergency stop signal is detected, the emergency stop function cannot be canceled even though the signal is canceled.
- If the minimum (or maximum) torque limit is set to 0%, the emergency stop function may not be able to stop the drive.

Settings

- Parameters [21.04 Emergency stop mode](#) (page 354), [21.05 Emergency stop source](#) (page 354), [23.23 Emergency stop time](#) (page 371), [31.32 Emergency ramp supervision](#) (page 400) and [31.33 Emergency ramp supervision delay](#) (page 401).

Diagnostics

■ Diagnostics menu

The **Diagnostics** menu provides quick information about active faults, warnings and inhibits in the drive and how to fix and reset them. It also helps you to find out why the drive is not starting, stopping or running at the desired speed.

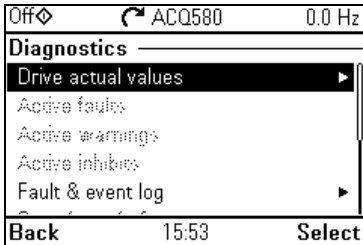

- **Drive actual values**
- **Active faults:** Use this view to see currently active faults and how to fix and reset them.
- **Active warnings:** Use this view to see currently active warnings and how to fix them.
- **Active inhibits:** Use this view to see the active inhibits and how to fix them. In addition, in the **Clock, region, display** menu you can disable (enabled by default) pop-up views showing information on inhibits when you try to start the drive but it is prevented.
- **Fault and event log:** Shows lists faults and other events.
- **Start/stop/reference summary:** Use this view to find out where the control comes from if the drive is not starting or stopping as expected, or runs at an undesired speed.
- **Limit status:** Use this view to find out whether any limitations are active if the drive is running at undesired speed.
- **Communication status:** Use this view to find out status information and sent and received data from fieldbus.
- **Motor summary:** Use this view to find out motor nominal values, control mode and whether ID run has been completed.

Settings

- **Menu > Diagnostics**
- **Menu > Primary settings > Clock, region, display > Show inhibit pop-up.**

Miscellaneous

■ Backup and restore

You can make backups of the settings manually to the assistant control panel. The assistant control panel also keeps one automatic backup. You can restore a backup to another drive, or a new drive replacing a faulty one. You can make backups and restore on the control panel or with the Drive composer PC tool.

Backup

Manual backup

Make a backup when necessary, for example, after you have started up the drive or when you want to copy the settings to another drive.

Parameter changes from fieldbus interfaces are ignored unless you have forced parameter saving with parameter [96.07 Parameter save manually](#).

Automatic backup



6

The assistant control panel has a dedicated space for one automatic backup. An automatic backup is created two hours after the last parameter change. After completing the backup, the control panel waits for 24 hours before checking if there are additional parameter changes. If there are, it creates a new backup overwriting the previous one when two hours have passed after the latest change.

You cannot adjust the delay time or disable the automatic backup function.

Parameter changes from fieldbus interfaces are ignored unless you have forced parameter saving with parameter [96.07 Parameter save manually](#).

Restore

The backups are shown on the control panel. Automatic backups are marked with icon  and manual backups with . To restore a backup, select it and press . In the following display you can view backup contents and restore all parameters or select a subset to be restored.

Note: To restore a backup, the drive has to be in Local control.

Note: There is a risk of removing the **QR code** menu entry permanently if a backup from a drive with an old firmware or old control panel firmware is restored to a drive with a new firmware from October 2014 or later.

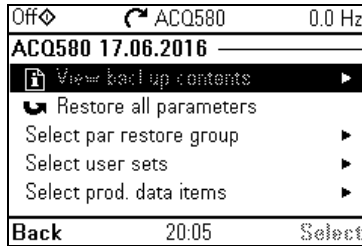
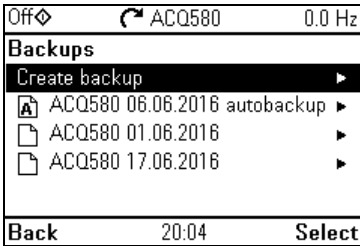

Settings

- **Menu > Backups**
- Parameter [96.07 Parameter save manually](#) (page 518).

■ Data storage parameters

Twelve (eight 32-bit, four 16-bit) parameters are reserved for data storage. These parameters are unconnected by default and can be used for linking, testing and commissioning purposes. They can be written to and read from using other parameters' source or target selections.

Settings

- Parameter group [47 Data storage](#) (page 465).

■ Parameter checksum calculation

Two parameter checksums, A and B, can be calculated from a set of parameters to monitor changes in the drive configuration. The sets are different for checksums A and B. Each of these checksum is compared to the corresponding reference checksum; in case of a mismatch, an event (a pure event, warning or fault) is generated. The calculated checksum can be set as the new reference checksum.

The set of parameters for checksum A does not include fieldbus settings.

The parameters included in the checksum A calculation are user editable parameters in parameter groups 10...13, 15, 19...25, 28, 30...32, 34...37, 40...41, 43, 45...46, 70...74, 76, 80, 94...99.

The set of parameters for checksum B does not include

- fieldbus settings
- motor data settings
- energy data settings.

The parameters included in the checksum B calculation are user editable parameters in parameter groups 10...13, 15, 19...25, 28, 30...32, 34, 35...37, 40...41, 43, 46, 70...74, 76, 80, 94...97.

Settings

- Parameters [96.54...96.69](#), [96.71...96.72](#) (page [522](#)).

■ User lock

For improved cybersecurity, it is highly recommended that you set a master pass code to prevent, for example, the changing of parameter values and/or the loading of firmware and other files.

 **WARNING! ABB will not be liable for damages or losses caused by the failure to activate the user lock using a new pass code.** See [Cybersecurity disclaimer](#) (page [20](#)).

6

- To activate the user lock for the first time:
- Enter the default pass code, 10000000, into [96.02 Pass code](#). This will make parameters [96.100...96.102](#) visible.
- Enter a new pass code into [96.100 Change user pass code](#). Always use eight digits; if using Drive composer PC tool, finish with Enter.
- Confirm the new pass code in [96.101 Confirm user pass code](#).

 **WARNING! Store the pass code in a safe place – even ABB cannot open the user lock if the pass code is lost.**

- In [96.102 User lock functionality](#), define the actions that you want to prevent (we recommend you select all the actions unless otherwise required by the application).
- Enter an invalid pass code into [96.02 Pass code](#).
- Activate [96.08 Control board boot](#), or cycle the power to the drive.
- Check that parameters [96.100...96.102](#) are hidden. If they are not, enter another random pass code into [96.02](#).

To reopen the lock, enter your pass code into [96.02 Pass code](#). This will again make parameters [96.100...96.102](#) visible.

Settings

- Parameters [96.02](#) (page [518](#)) and [96.100...96.102](#) (page [525](#)).
-

■ Sine filter support

With a sine filter connected to the output of the drive, the drive must use scalar motor control mode, and limit the switching and output frequencies to

- prevent the drive from operating at filter resonance frequencies, and
- protect the filter from overheating.

When using ABB sine filters (available separately), this is done automatically when you switch bit 1 of [95.15 Special HW settings](#) on.

Contact your local ABB representative before connecting a sine filter from another manufacturer.

Settings

- Parameter [95.15 Special HW settings](#) (page [513](#)).

7

Fault tracing

What this chapter contains

The chapter lists the warning and fault messages including possible causes and corrective actions. The causes of most warnings and faults can be identified and corrected using the information in this chapter. If not, contact an ABB service representative. If you have a possibility to use the Drive composer PC tool, send the Support package created by the Drive composer to the ABB service representative.

Warnings and faults are listed below in separate tables. Each table is sorted by warning/fault code.

Safety



WARNING! Only qualified electricians are allowed to service the drive. Read the instructions in chapter *Safety instructions* at the beginning of the *Hardware manual* of the drive before working on the drive.

Indications

■ Warnings and faults

Warnings and faults indicate an abnormal drive status. The codes and names of active warnings and faults are displayed on the control panel of the drive as well as in the Drive composer PC tool. Only the codes of warnings and faults are available over fieldbus.

Warnings do not need to be reset; they stop showing when the cause of the warning ceases. Warnings do not trip the drive and it will continue to operate the motor.

Faults latch inside the drive and cause the drive to trip, and the motor stops. After the cause of a fault has been removed, the fault can be reset from the control panel or from a selectable source (parameter [31.11 Fault reset selection](#)) such as the digital inputs of the drive. Resetting the fault creates an event [64FF Fault reset](#). After the reset, the drive can be restarted.

Note that some faults require a reboot of the control unit either by switching the power off and on, or using parameter [96.08 Control board boot](#) – this is mentioned in the fault listing wherever appropriate.

■ Pure events

In addition to warnings and faults, there are pure events that are only recorded in the event log of the drive. The codes of these events are included in the [Warning messages](#) table on page [190](#).

■ Editable messages

For external events, the action (fault or warning), name and the message text can be edited. To specify external events, select **Menu > Primary settings > Advanced functions > External events**.

Contact information can also be included and the text edited. To specify contact information, select **Menu > Primary settings > Clock, region, display > Contact info view**.

7

Warning/fault history

■ Event log

All indications are stored in the event log with a time stamp and other information. The event log stores information on

- the last 8 fault recordings, that is, faults that tripped the drive or fault resets
- the last 10 warnings or pure events that occurred.

See section [Viewing warning/fault information](#) on page [189](#).

To clear the fault and event logger, select **Menu > Primary settings > Reset to defaults > Reset fault and event logs**, or set parameter [96.51 Clear fault and event logger](#) to value Clear.

Auxiliary codes

Some events generate an auxiliary code that often helps in pinpointing the problem. On the control panel, the auxiliary code is stored as part of the details of the event; in the Drive composer PC tool, the auxiliary code is shown in the event listing.

■ Viewing warning/fault information

The drive is able to store a list of the active faults actually causing the drive to trip at the present time. The drive also stores a list of faults and warnings that have previously occurred.

For each stored fault, the control panel shows the fault code, time and values of nine parameters (actual signals and status words) stored at the time of the fault. The values of the parameters for the latest fault are in parameters [05.80](#)...[05.89](#).

For active faults and warnings, see

- **Menu > Diagnostics > Active faults**
- **Menu > Diagnostics > Active warnings**
- parameters in group [04 Warnings and faults](#) (page [293](#)).

For previously occurred faults and warnings, see

- **Menu > Diagnostics > Fault & event log**
- parameters in group [04 Warnings and faults](#) (page [293](#)).

The event log can also be accessed (and reset) using the Drive composer PC tool. See *Drive composer PC tool user's manual* (3AUA0000094606 [English]).

QR code generation for mobile service application

A QR code (or a series of QR codes) can be generated by the drive for display on the control panel. The QR code contains drive identification data, information on the latest events, and values of status and counter parameters. The code can be read with a mobile device containing the ABB service application, which then sends the data to ABB for analysis. For more information on the application, contact your local ABB service representative.

To generate the QR code, select **Menu > System info > QR code**.

Note: If a control panel which does not support QR code generation (version older than v.6.4x) is used, the **QR code** menu entry will disappear totally and will not be available any longer either with control panels supporting the QR code generation.

Note: There is a risk of removing the **QR code** menu permanently if a backup from a drive with an old firmware or old panel firmware is restored to a drive with a new firmware from October 2014 or later.

Warning messages

Note: The list also contains events that only appear in the Event log.

Code (hex)	Warning / Aux. code	Cause	What to do
A2B1	Overcurrent	Output current has exceeded internal fault limit. In addition to an actual overcurrent situation, this warning may also be caused by an earth fault or supply phase loss.	<p>Check motor load.</p> <p>Check acceleration times in parameter group 23 Speed reference ramp (speed control) or 28 Frequency reference chain (frequency control). Also check parameters 46.01 Speed scaling, 46.02 Frequency scaling and 46.03 Torque scaling.</p> <p>Check motor and motor cable (including phasing and delta/star connection). Check for an earth fault in motor or motor cables by measuring the insulation resistances of motor and motor cable. See chapter <i>Electrical installation</i>, section <i>Checking the insulation of the assembly</i> in the <i>Hardware manual</i> of the drive.</p> <p>Check there are no contactors opening and closing in motor cable.</p> <p>Check that the start-up data in parameter group 99 Motor data corresponds to the motor rating plate.</p> <p>Check that there are no power factor correction capacitors or surge absorbers in motor cable.</p>
A2B3	Earth leakage	Drive has detected load unbalance typically due to earth fault in motor or motor cable.	<p>Check there are no power factor correction capacitors or surge absorbers in motor cable.</p> <p>Check for an earth fault in motor or motor cables by measuring the insulation resistances of motor and motor cable. See chapter <i>Electrical installation</i>, section <i>Checking the insulation of the assembly</i> in the <i>Hardware manual</i> of the drive. If an earth fault is found, fix or change the motor cable and/or motor. If no earth fault can be detected, contact your local ABB representative.</p>
A2B4	Short circuit	Short-circuit in motor cable(s) or motor.	<p>Check motor and motor cable for cabling errors.</p> <p>Check motor and motor cable (including phasing and delta/star connection). Check for an earth fault in motor or motor cables by measuring the insulation resistances of motor and motor cable. See chapter <i>Electrical installation</i>, section <i>Checking the insulation of the assembly</i> in the <i>Hardware manual</i> of the drive.</p> <p>Check there are no power factor correction capacitors or surge absorbers in motor cable.</p>

Code (hex)	Warning / Aux. code	Cause	What to do
A2BA	IGBT overload	Excessive IGBT junction to case temperature. This warning protects the IGBT(s) and can be activated by a short circuit in the motor cable.	Check motor cable. Check ambient conditions. Check air flow and fan operation. Check heatsink fins for dust pick-up. Check motor power against drive power.
A3A1	DC link overvoltage	Intermediate circuit DC voltage too high (when the drive is stopped).	Check the supply voltage setting (parameter 95.01 Supply voltage). Note that the wrong setting of the parameter may cause the motor to rush uncontrollably, or may overload the brake chopper or resistor. Check the supply voltage. If the problem persists, contact your local ABB representative.
A3A2	DC link undervoltage	Intermediate circuit DC voltage too low (when the drive is stopped).	
A3AA	DC not charged	The voltage of the intermediate DC circuit has not yet risen to operating level.	
A490	Incorrect temperature sensor setup	Temperature cannot be supervised due to incorrect adapter setup.	Check the settings of temperature source parameters 35.11 and 35.21 .
A491	External temperature 1 (Editable message text)	Measured temperature 1 has exceeded warning limit.	Check the value of parameter 35.02 Measured temperature 1 . Check the cooling of the motor (or other equipment whose temperature is being measured). Check the value of 35.13 Temperature 1 warning limit .
A492	External temperature 2 (Editable message text)	Measured temperature 2 has exceeded warning limit.	Check the value of parameter 35.03 Measured temperature 2 . Check the cooling of the motor (or other equipment whose temperature is being measured). Check the value of 35.23 Temperature 2 warning limit .
A4A0	Control board temperature	Control board temperature is too high.	Check the auxiliary code. See actions for each code below.
	(none)	Temperature above warning limit	Check ambient conditions. Check air flow and fan operation. Check heatsink fins for dust pick-up.
	0001	Thermistor broken	Contact an ABB service representative for control board replacement.
A4A1	IGBT overtemperature	Estimated drive IGBT temperature is excessive.	Check ambient conditions. Check air flow and fan operation. Check heatsink fins for dust pick-up. Check motor power against drive power.

Code (hex)	Warning / Aux. code	Cause	What to do
A4A9	Cooling	Drive module temperature is excessive.	Check ambient temperature. If it exceeds 40 °C/104 °F (IP21 frames R4...R9) or if it exceeds 50 °C /122 °F (IP21 frames R1...R9), ensure that load current does not exceed derated load capacity of the drive. For all P55 frames, check the derating temperatures. See chapter <i>Technical data</i> , section <i>Derating</i> in the <i>Hardware manual</i> of the drive. Check drive module cooling air flow and fan operation. Check inside of cabinet and heatsink of drive module for dust pick-up. Clean whenever necessary.
A4B0	Excess temperature	Power unit module temperature is excessive.	Check ambient conditions. Check air flow and fan operation. Check heatsink fins for dust pick-up. Check motor power against drive power. Check the auxiliary code.
	FA	Ambient temperature	
A4B1	Excess temperature difference	High temperature difference between the IGBTs of different phases.	Check the motor cabling. Check cooling of drive module(s).
A4F6	IGBT temperature	Drive IGBT temperature is excessive.	Check ambient conditions. Check air flow and fan operation. Check heatsink fins for dust pick-up. Check motor power against drive power.
A581	Fan	Cooling fan feedback missing.	Check the auxiliary code to identify the fan. Code 0 denotes main fan 1. Other codes (format XYZ): "X" specifies state code (1 : ID run, 2 : normal). "Y" = 0, "Z" specifies the index of the fan (1 : Main fan 1, 2 : Main fan 2, 3 : Main fan 3). Check fan operation and connection. Replace fan if faulty.
A582	Auxiliary fan missing	An auxiliary cooling fan (IP55 internal fan) is stuck or disconnected.	Check the auxiliary code. Check the auxiliary fan and connection. Replace faulty fan. Make sure the front cover of the drive is in place and tightened. If the commissioning of the drive requires that the cover is off, set parameter 31.36 Aux fan fault function temporarily to value <i>No action</i> within two minutes from power-up.
A5A0	Safe torque off Programmable warning: 31.22 STO indication run/stop	Safe torque off function is active, ie, safety circuit signal(s) connected to connector STO is lost.	Check safety circuit connections. For more information, chapter <i>The Safe torque off function</i> in the <i>Hardware manual</i> of the drive and description of parameter 31.22 STO indication run/stop (page 396). Check the value of parameter 95.04 Control board supply .

Code (hex)	Warning / Aux. code	Cause	What to do
A5EA	Measurement circuit temperature	Problem with internal temperature measurement of the drive.	Check the auxiliary code. They depend on the control unit type.
		Frames R1...R5	Contact your local ABB representative.
	0000 0001	IGBT temperature	
	0000 0003	Board temperature	
	0000 0006	Power supply temperature	
		Frames R6...R11 and ACx580-31 frame R3	Contact your local ABB representative.
	0000 0001	U-phase IGBT	
	0000 0002	V-phase IGBT	
	0000 0003	W-phase IGBT	
	0000 0004	Board temperature	
	0000 0005	Brake chopper	
	0000 0006	Air inlet (TEMP3)	
	0000 0007	Power supply temperature	
	0000 0008	du/dt (TEMP2)	
	0000 0009	TEMP1	
	FAh =1111 1010	Ambient temperature	
A5EB	PU board powerfail	Power unit power supply failure.	Contact your local ABB representative.
A5ED	Measurement circuit ADC	Measurement circuit fault.	Contact your local ABB representative.
A5EE	Measurement circuit DFF	Measurement circuit fault.	Contact your local ABB representative.
A5EF	PU state feedback	State feedback from output phases does not match control signals.	Contact your local ABB representative.
A5F0	Charging feedback	Charging feedback signal missing.	Check the feedback signal coming from the charging system.
A682	Flash erase speed exceeded	The flash memory (in the memory unit) has been erased too frequently, compromising the lifetime of the memory.	Avoid forcing unnecessary parameter saves by parameter 96.07 or cyclic parameter writes (such as user logger triggering through parameters). Check the auxiliary code (format YYYY YZZZ). "X" specifies the source of warning (1: generic flash erase supervision). "ZZZ" specifies the flash subsector number that generated the warning.
A686	Checksum mismatch Programmable warning: 96.54 Checksum action	The calculated parameter checksum does not match any enabled reference checksum.	Check that all necessary approved (reference) checksums (96.71...96.72) are enabled in 96.55 Checksum control word . Check the parameter configuration. Using 96.55 Checksum control word , enable a checksum parameter and copy the actual checksum into that parameter.



Code (hex)	Warning / Aux. code	Cause	What to do
A687	Checksum configuration	An action has been defined for a parameter checksum mismatch but the feature has not been configured.	Contact your local ABB representative for configuring the feature, or disable the feature in 96.54 Checksum action .
A6A4	Motor nominal value	The motor parameters are set incorrectly.	Check the auxiliary code. See actions for each code below.
		The drive is not dimensioned correctly.	
		0001 Slip frequency is too small.	
		0002 Synchronous and nominal speeds differ too much.	
		0003 Nominal speed is higher than synchronous speed with 1 pole pair.	
		0004 Nominal current is outside limits	
		0005 Nominal voltage is outside limits.	
		0006 Nominal power is higher than apparent power.	
	0007 Nominal power not consistent with nominal speed and torque.	Check the settings of the motor configuration parameters in groups 98 and 99. Check that the drive is sized correctly for the motor.	
A6A5	No motor data	Parameters in group 99 have not been set.	Check that all the required parameters in group 99 have been set. Note: It is normal for this warning to appear during the start-up and continue until the motor data is entered.
A6A6	Voltage category unselected	The voltage category has not been defined.	Set voltage category in parameter 95.01 Supply voltage .
A6A7	System time not set	System time is not set. Timed functions cannot be used and fault log dates are not correct.	Set the system time manually or connect the control panel to the drive to synchronize the clock. If basic control panel is used, synchronize the clock through the EFB or a fieldbus module. Set parameter 34.10 Timed functions enable to <i>Disabled</i> to disable the timed functions if they are not used.
A6B0	User lock is open	The user lock is open, ie, user lock configuration parameters 96.100...96.102 are visible.	Close the user lock by entering an invalid pass code in parameter 96.02 Pass code . See section Parameter checksum calculation (page 183).
A6B1	User pass code not confirmed	A new user pass code has been entered in parameter 96.100 but not confirmed in 96.101 .	Confirm the new pass code by entering the same code in 96.101 . To cancel, close the user lock without confirming the new code. See section Parameter checksum calculation (page 183).
A6D1	FBA A parameter conflict	The drive does not have a functionality requested by a PLC, or requested functionality has not been activated.	Check PLC programming. Check settings of parameter group 50 Fieldbus adapter (FBA) .

Code (hex)	Warning / Aux. code	Cause	What to do
A6E5	AI parametrization	The current/voltage hardware setting of an analog input does not correspond to parameter settings.	Check the event log for an auxiliary code. The code identifies the analog input whose settings are in conflict. Adjust either the hardware setting (on the drive control unit) or parameter 12.15/12.25 . Note: Control board reboot (either by cycling the power or through parameter 96.08 Control board boot) is required to validate any changes in the hardware settings.
A6E6	ULC configuration	User load curve configuration error.	Check the auxiliary code. See actions for each code below.
	0000	Speed points inconsistent.	Check that each speed point (parameters 37.11...37.15) has a higher value than the previous point.
	0001	Frequency points inconsistent.	Check that each frequency point (37.20...37.16) has a higher value than the previous point.
	0002	Underload point above overload point.	Check that each overload point (37.31...37.35) has a higher value than the corresponding underload point (37.21...37.25).
	0003	Overload point below underload point.	
A6E7	IPC configuration warning	IPC configuration error.	Check the auxiliary code. See actions for each code below.
	0001	IPC incorrectly configured for EFB.	Check that if parameter 76.21 Multipump configuration is set to <i>IPC, Level control - Emptying</i> or <i>Level control - Filling</i> , parameter 58.01 Protocol enable is set to <i>None / IPC communication</i> . Check that if 58.01 Protocol enable is set to <i>None / IPC communication</i> , 76.21 Multipump configuration is set to <i>IPC, Level control - Emptying</i> or <i>Level control - Filling</i> , and 76.24 IPC communication port is set to <i>EFB</i> .
	0002	IPC incorrectly configured for FBA.	Check that if parameter 76.21 Multipump configuration is set to none of <i>IPC, Level control - Emptying</i> or <i>Level control - Filling</i> , parameter 50.01 FBA A enable is set to <i>Disable</i> .
A780	Motor stall Programmable warning: 31.24 Stall function	Motor is operating in stall region because of, for example, excessive load or insufficient motor power.	Check motor load and drive ratings. Check fault function parameters.
A783	Motor overload	Motor current is too high.	Check for overloaded motor. Adjust the parameters used for the motor overload function (35.51...35.53) and 35.55...35.56 .

Code (hex)	Warning / Aux. code	Cause	What to do
A784	Motor disconnect	All three output phases are disconnected from motor.	Check that switches between drive and motor are closed. Check that all cables between drive and motor are connected and secured. If no issue was detected and drive output was actually connected to motor, contact ABB.
A792	Brake resistor wiring	Brake resistor short circuit or brake chopper control fault. For drive frames R6 or larger.	Check brake chopper and brake resistor connection. Ensure brake resistor is not damaged.
A793	BR excess temperature	Brake resistor temperature has exceeded warning limit defined by parameter 43.12 Brake resistor warning limit .	Stop drive. Let resistor cool down. Check resistor overload protection function settings (parameter group 43 Brake chopper). Check warning limit setting, parameter 43.12 Brake resistor warning limit . Check that the resistor has been dimensioned correctly. Check that braking cycle meets allowed limits.
A794	BR data	Brake resistor data has not been given.	One or more of the resistor data settings (parameters 43.08...43.10) is incorrect. The parameter is specified by the auxiliary code.
	0000 0001	Resistance value too low.	Check value of 43.10 Brake resistance .
	0000 0002	Thermal time constant not given.	Check value of 43.08 Brake resistor thermal tc .
	0000 0003	Maximum continuous power not given.	Check value of 43.09 Brake resistor Pmax cont .
A79C	BC IGBT excess temperature	Brake chopper IGBT temperature has exceeded internal warning limit.	Let chopper cool down. Check for excessive ambient temperature. Check for cooling fan failure. Check for obstructions in the air flow. Check the dimensioning and cooling of the cabinet. Check resistor overload protection function settings (parameters 43.06...43.10). Check minimum allowed resistor value for the chopper being used. Check that braking cycle meets allowed limits. Check that drive supply AC voltage is not excessive.
A7AB	Extension I/O configuration failure	Installed extension module is not the same as configured.	Check that the installed extension module (shown by parameter 15.02 Detected extension module) is the same as selected by parameter 15.01 Extension module type .

Code (hex)	Warning / Aux. code	Cause	What to do
A7C1	FBA A communication Programmable warning: 50.02 FBA A comm loss func	Cyclical communication between drive and fieldbus adapter module A or between PLC and fieldbus adapter module A is lost.	Check status of fieldbus communication. See user documentation of fieldbus interface. Check settings of parameter groups 50 Fieldbus adapter (FBA) , 51 FBA A settings , 52 FBA A data in and 53 FBA A data out . Check cable connections. Check if communication master is able to communicate.
A7CE	EFB comm loss Programmable warning: 58.14 Communication loss action	Communication break in embedded fieldbus (EFB) communication.	Check the status of the fieldbus master (online/offline/error etc.). Check cable connections to the EIA-485/X5 terminals 29, 30 and 31 on the control unit.
A7EE	Panel loss Programmable warning: 49.05 Communication loss action	Control panel or PC tool selected as active control location for drive has ceased communicating.	Check PC tool or control panel connection. Check control panel connector. Check mounting platform if being used. Disconnect and reconnect the control panel.
A88F	Cooling fan	Maintenance timer limit exceeded.	Consider changing the cooling fan. Parameter 05.04 Fan on-time counter shows the running time of the cooling fan.
A8A0	AI supervision Programmable warning: 12.03 AI supervision function	An analog signal is outside the limits specified for the analog input.	Check signal level at the analog input. Check the wiring connected to the input. Check the minimum and maximum limits of the input in parameter group 12 Standard AI .
A8A1	RO life warning	The relay has changed states more than the recommended number of times.	Change the control board or stop using the relay output. Check the auxiliary code, which identifies the relay output.
	0001	Relay output 1	Change the control board or stop using relay output 1.
	0002	Relay output 2	Change the control board or stop using relay output 2.
	0003	Relay output 3	Change the control board or stop using relay output 3.
A8A2	RO toggle warning	The relay output is changing states faster than recommended, for example, if a fast changing frequency signal is connected to it. The relay lifetime will be exceeded shortly.	Replace the signal connected to the relay output source with a less frequently changing signal. Check the auxiliary code, which identifies the relay output source parameter.
	0001	Relay output 1	Select a different signal with parameter 10.24 RO1 source .
	0002	Relay output 2	Select a different signal with parameter 10.27 RO2 source .
	0003	Relay output 3	Select a different signal with parameter 10.30 RO3 source .

Code (hex)	Warning / Aux. code	Cause	What to do
A8B0	ABB Signal supervision 1 (Editable message text) Programmable warning: 32.06 Supervision 1 action	Warning generated by the signal supervision function 1.	Check the source of the warning (parameter 32.07 Supervision 1 signal).
A8B1	ABB Signal supervision 2 (Editable message text) Programmable warning: 32.16 Supervision 2 action	Warning generated by the signal supervision function 2.	Check the source of the warning (parameter 32.17 Supervision 2 signal).
A8B2	ABB Signal supervision 3 (Editable message text) Programmable warning: 32.26 Supervision 3 action	Warning generated by the signal supervision function 3.	Check the source of the warning (parameter 32.27 Supervision 3 signal).
A8B3	ABB Signal supervision 4 (Editable message text) Programmable warning: 32.36 Supervision 4 action	Warning generated by the signal supervision function 4.	Check the source of the warning (parameter 32.37 Supervision 4 signal).
A8B4	ABB Signal supervision 5 (Editable message text) Programmable warning: 32.46 Supervision 5 action	Warning generated by the signal supervision function 5.	Check the source of the warning (parameter 32.47 Supervision 5 signal).
A8B5	ABB Signal supervision 6 (Editable message text) Programmable warning: 32.56 Supervision 6 action	Warning generated by the signal supervision function 6.	Check the source of the warning (parameter 32.57 Supervision 6 signal).
A8BE	ULC overload warning Programmable fault: 37.03 ULC overload actions	Selected signal has exceeded the user overload curve.	Check for any operating conditions increasing the monitored signal (for example, the loading of the motor if the torque or current is being monitored). Check the definition of the load curve (parameter group 37 User load curve).
A8BF	ULC underload warning Programmable fault: 37.04 ULC underload actions	Selected signal has fallen below the user underload curve.	Check for any operating conditions decreasing the monitored signal (for example, loss of load if the torque or current is being monitored). Check the definition of the load curve (parameter group 37 User load curve).
A981	External warning 1 (Editable message text) Programmable warning: 31.01 External event 1 source 31.02 External event 1 type	Fault in external device 1.	Check the external device. Check setting of parameter 31.01 External event 1 source .
A982	External warning 2 (Editable message text) Programmable warning: 31.03 External event 2 source 31.04 External event 2 type	Fault in external device 2.	Check the external device. Check setting of parameter 31.03 External event 2 source .

Code (hex)	Warning / Aux. code	Cause	What to do
A983	External warning 3 (Editable message text) Programmable warning: 31.05 External event 3 source 31.06 External event 3 type	Fault in external device 3.	Check the external device. Check setting of parameter 31.05 External event 3 source .
A984	External warning 4 (Editable message text) Programmable warning: 31.07 External event 4 source 31.08 External event 4 type	Fault in external device 4.	Check the external device. Check setting of parameter 31.07 External event 4 source .
A985	External warning 5 (Editable message text) Programmable warning: 31.09 External event 5 source 31.10 External event 5 type	Fault in external device 5.	Check the external device. Check setting of parameter 31.09 External event 5 source .
AF80	INU-LSU comm loss Programmable warning: 60.79 INU-LSU comm loss function	DDCS (fiber optic) communication between converters (for example, the inverter unit and the supply unit) is lost. Note that the inverter unit will continue operating based on the status information that was last received from the other converter.	Only for ACQ580-31 and ACQ580-34. Check status of other converter (parameters 06.36 and 06.39). Check settings of parameter group 60 DDCS communication . Check the corresponding settings in the control program of the other converter. Check cable connections. If necessary, replace cables.
AF85	Line side unit warning	The supply unit (or other converter) has generated a warning.	Only for ACQ580-31 and ACQ580-34. The auxiliary code specifies the original warning code in the supply unit control program. You can find the most common auxiliary codes in section Auxiliary codes for the LSU supply unit warnings on page 218 . For full information, chapter <i>Fault tracing</i> in <i>ACS880 IGBT supply control program firmware manual</i> (3AUA0000131562 [English]).
AF88	Season configuration warning	You have configured a season which starts before the previous season.	Configure the seasons with increasing start dates, see parameters 34.60 Season 1 start date... 34.63 Season 4 start date .
AF90	Speed controller autotuning	The speed controller autotune routine did not complete successfully.	Check the auxiliary code. See actions for each code below.
	0000	Drive was stopped before the autotune was complete.	Start the drive and repeat autotune until successful.
	0001	The drive was started and it was not ready to follow the autotune command.	Make sure the prerequisites of the autotune run are fulfilled. See section Before activating the autotune routine (page 164).

Code (hex)	Warning / Aux. code	Cause	What to do
	0002	Required torque reference could not be reached before the drive reached maximum speed.	Decrease the torque step (parameter 25.38) or increase the speed step (parameter 25.39).
	0003	Motor could not accelerate/ to maximum speed.	Increase the torque step (parameter 25.38) or decrease the speed step (parameter 25.39).
	0004	Motor could not decelerate to minimum speed.	Increase the torque step (parameter 25.38) or decrease the speed step (parameter 25.39).
	0005	Motor could not decelerate with full autotune torque.	Decrease the torque step (parameter 25.38) or the speed step (parameter 25.39).
	0006	Autotune could not write a parameter.	Run the drive one more time.
	0007	Drive was ramping down when the autotune was activated.	Run the drive to the set point and start the autotune one more time.
	0008	Drive was ramping up when the autotune was activated.	Wait until the drive reaches the set point and start autotune.
	0009	Drive was running outside of autotune speed limits during the autotune activation.	Check the limits, set the correct setpoint and repeat the autotune.
AFAA	Autoreset	A fault is about to be autoreset.	Informative warning. See the settings in parameter group 31 Fault functions .
AFE1	Emergency stop (off2)	Drive has received an emergency stop (mode selection off2) command.	Check that it is safe to continue operation. Then return emergency stop push button to normal position. Restart drive.
AFE2	Emergency stop (off1 or off3)	Drive has received an emergency stop (mode selection off1 or off3) command.	If the emergency stop was unintentional, check the source selected by parameter 21.05 Emergency stop source .
AFE9	Start delay	The start delay is active and the drive will start the motor after a predefined delay.	Informative warning. See parameter 21.22 Start delay .
AFED	Run permissive	Run permissive is keeping the drive from running the motor.	Check the setting of (and source selected by) parameter 20.40 Run permissive .
AFEE	Start interlock 1	Start interlock 1 is keeping the drive from starting.	Check the signal source selected for parameter 20.41 Start interlock 1 .
AFEF	Start interlock 2	Start interlock 2 is keeping the drive from starting.	Check the signal source selected for parameter 20.42 Start interlock 2 .
AFF0	Start interlock 3	Start interlock 3 is keeping the drive from starting.	Check the signal source selected for parameter 20.43 Start interlock 3 .
AFF1	Start interlock 4	Start interlock 4 is keeping the drive from starting.	Check the signal source selected for parameter 20.44 Start interlock 4 .
AFF6	Identification run	Motor ID run will occur at next start.	Informative warning.

Code (hex)	Warning / Aux. code	Cause	What to do
AF88	Motor heating active	Pre-heating is being performed	Informative warning. Motor pre-heating is active. Current specified by parameter 21.16 Pre-heating current is being passed through the motor.
B5A0	STO event Programmable event: 31.22 STO indication run/stop	Safe torque off function is active, ie, safety circuit signal(s) connected to connector STO is lost.	Informative warning. Check safety circuit connections. For more information, see chapter <i>The Safe torque off function</i> in the <i>Hardware manual</i> of the drive and description of parameter 31.22 STO indication run/stop (page 396).
B681	Hand mode selected	The drive was placed in Hand mode.	Informative event. Check the control panel to ensure that the current control location is correct.
B682	Off mode selected	The drive was placed in Off mode.	Informative event. Check the control panel to ensure that the current control location is correct.
B683	Auto mode selected	The drive was placed in Auto mode.	Informative event. Check the control panel to ensure that the current control location is correct.
B686	Checksum mismatch Programmable event: 96.54 Checksum action	The calculated parameter checksum does not match any enabled reference checksum.	See A686 Checksum mismatch (page 193).
D501	No more available PFC motors	No more PFC motors can be started because they can be interlocked or in the Hand mode.	Check that there are no interlocked PFC motors, see parameters: 76.81...76.84 . If all motors are in use, the PFC system is not adequately dimensioned to handle the demand.
D502	All motors interlocked	All the motors in the PFC system are interlocked.	Check that there are no interlocked PFC motors, see parameters 76.81...76.84 .
D503	VSD controlled PFC motor interlocked	The motor connected to the drive is interlocked (unavailable).	Motor connected to the drive is interlocked and thus cannot be started. Remove the corresponding interlock to start the drive controlled PFC motor. See parameters 76.81...76.84 .
D505	Max cleaning warning Programmable warning: 83.35 Cleaning count fault	Maximum number of cleanings are reached in defined time. The Pump cleaning is unable to clean the pump and hence, manual cleaning is required.	Check the pump for blockages. Clean the pump manually if needed. Check parameters 83.35 Cleaning count fault to 83.37 Maximum cleaning count .
D506	Pump cleaning not possible	Pump cleaning cannot be started. The drive needs to be in remote control and start signal is activated.	Change control location to Auto.
D507	Pump cleaning needed	Dirt detection indicates that the pump needs cleaning but automatic pump cleaning is not allowed.	Perform pump cleaning manually. Start pump cleaning by changing parameter 83.12 Manually force cleaning to Start cleaning now .

Code (hex)	Warning / Aux. code	Cause	What to do
D508	High level Programmable warning: 76.93 LC high level action	Water level is reached the high level limit. Level control is unable to control the level for the following reasons: <ul style="list-style-type: none"> • running out of pumping capacity. • analog feedback sensor failure. 	Check analog level sensor. Check that all the pumps are operating normally. Check parameters 76.91 LC high level switch and 76.93 LC high level action .
D509	Low level Programmable warning: 76.92 LC low level action	Water level is reached the low level limit. Level control is unable to control the level for the following reasons: <ul style="list-style-type: none"> • running out of pumping capacity. • analog feedback sensor failure. 	Check analog level sensor. Check that all the pumps are operating normally. Check parameters 76.90 LC low level switch and 76.92 LC low level action .
D50A	Running dry Programmable warning: 82.20 Dry run protection	Dry run protection is activated.	Check the pump inlet for sufficient water level. Check dry run protection settings in parameters 82.20 Dry run protection and 82.21 Dry run source .
D50B	Pipe fill-timeout Programmable warning: 82.25 Soft pipe fill supervision	Soft pipe fill is reached the timeout limit. The PID output is not reached the setpoint after reference ramping is ended and timeout limit is elapsed.	Check the pipe for possible leakage. See parameter 82.25 Soft pipe fill supervision and 82.26 Time-out limit .
D50C	Maximum flow protection Programmable warning: 80.17 Maximum flow protection	Actual flow is exceeded the defined warning level.	Check the system for leakages. Check flow protection settings in parameters 80.15 Maximum flow , 80.17 Maximum flow protection and 80.19 Flow check delay .
D50D	Minimum flow protection Programmable warning: 80.18 Minimum flow protection	Actual flow is below the defined warning level.	Check that the inlet and outlet valves are open. Check flow protection settings in parameters 80.16 Minimum flow , 80.18 Minimum flow protection and 80.19 Flow check delay .
D50E	Outlet minimum pressure Programmable warning: 82.30 Outlet minimum pressure protection	Measured outlet pressure is below the defined warning limit.	Check the pump outlet for leakages. Check the configuration of outlet pressure protection. See parameters 82.30 Outlet minimum pressure protection and 82.31 Outlet minimum pressure warning level .
D50F	Outlet maximum pressure Programmable warning: 82.35 Outlet maximum pressure protection	Measured outlet pressure is above the defined warning limit.	Check the pump outlet for blockages or closed valve. Check the configuration of outlet pressure protection. See parameters 82.35 Outlet maximum pressure protection and 82.37 Outlet maximum pressure warning level

Code (hex)	Warning / Aux. code	Cause	What to do
D510	Inlet minimum pressure Programmable warning: 82.40 Inlet minimum pressure protection	Measured inlet pressure is below the defined warning level.	Check the pump inlet for blockages or closed valve. Check the configuration of inlet pressure protection. See parameters 82.40 Inlet minimum pressure protection and 82.41 Inlet minimum pressure warning level .

Fault messages

Code (hex)	Fault / Aux. code	Cause	What to do
1080	Backup/Restore timeout	Control panel or PC tool has failed to communicate with the drive when backup was being made or restored.	Request backup or restore again.
1081	Rating ID fault	Drive software has not been able to read the rating ID of the drive.	Reset the fault to make the drive try to reread the rating ID. If the fault reappears, cycle the power to the drive. You may have to repeat this. If the fault persists, contact your local ABB representative.
2281	Calibration	Measured offset of output phase current measurement or difference between output phase U2 and W2 current measurement is too great (the values are updated during current calibration).	Try performing the current calibration again (select <i>Current measurement calibration</i> at parameter <i>99.13 ID run requested</i>). If the fault persists, contact your local ABB representative. Auxiliary codes are shown below.
	0001	Too high offset error in U-phase current.	
	0002	Too high offset error in V-phase current.	
	0003	Too high offset error in W-phase current.	
	0004	Too high gain difference detected between phase current measurements.	
2310	Overcurrent	Output current has exceeded internal fault limit. In addition to an actual overcurrent situation, this fault may also be caused by an earth fault or supply phase loss.	Check motor load. Check acceleration times in parameter group <i>23 Speed reference ramp</i> (speed control) or <i>28 Frequency reference chain</i> (frequency control). Also check parameters <i>46.01 Speed scaling</i> , <i>46.02 Frequency scaling</i> and <i>46.03 Torque scaling</i> . Check motor and motor cable (including phasing and delta/star connection). Check there are no contactors opening and closing in motor cable. Check that the start-up data in parameter group 99 corresponds to the motor rating plate. Check that there are no power factor correction capacitors or surge absorbers in motor cable. Check for an earth fault in motor or motor cables by measuring the insulation resistances of motor and motor cable. See chapter <i>Electrical installation</i> , section <i>Checking the insulation of the assembly</i> in the <i>Hardware manual</i> of the drive.

Code (hex)	Fault / Aux. code	Cause	What to do
2330	Earth leakage	Drive has detected load unbalance typically due to earth fault in motor or motor cable.	<p>Check there are no power factor correction capacitors or surge absorbers in motor cable.</p> <p>Check for an earth fault in motor or motor cables by measuring the insulation resistances of motor and motor cable.</p> <p>Try running the motor in scalar control mode if allowed. (See parameter 99.04 Motor control mode.)</p> <p>If no earth fault can be detected, contact your local ABB representative.</p>
2340	Short circuit	Short-circuit in motor cable(s) or motor.	<p>Check motor and motor cable for cabling errors.</p> <p>Check there are no power factor correction capacitors or surge absorbers in motor cable.</p> <p>Cycle the power to the drive.</p> <p>Auxiliary codes are shown below.</p>
	0080	State feedback from output phases does not match control signals. For frames R6 and R7.	
2381	IGBT overload	Excessive IGBT junction to case temperature. This fault protects the IGBT(s) and can be activated by a short circuit in the motor cable.	<p>Check motor cable.</p> <p>Check ambient conditions.</p> <p>Check air flow and fan operation.</p> <p>Check heatsink fins for dust pick-up.</p> <p>Check motor power against drive power.</p>
3130	Input phase loss Programmable fault: 31.21 Supply phase loss	Intermediate circuit DC voltage is oscillating due to missing input power line phase or blown fuse.	<p>Check input power line fuses.</p> <p>Check for loose power cable connections.</p> <p>Check for input power supply imbalance.</p>
3181	Wiring or earth fault Programmable fault: 31.23 Wiring or earth fault	Incorrect input power and motor cable connection (ie. input power cable is connected to drive motor connection).	Check input power connections.
3210	DC link overvoltage	Excessive intermediate circuit DC voltage.	<p>Check that overvoltage control is on (parameter 30.30 Overvoltage control).</p> <p>Check that the supply voltage matches the nominal input voltage of the drive.</p> <p>Check the supply line for static or transient overvoltage.</p> <p>Check brake chopper and resistor (if present).</p> <p>Check deceleration time.</p> <p>Use coast-to-stop function (if applicable).</p> <p>Retrofit drive with brake chopper and brake resistor.</p> <p>Check that the brake resistor is dimensioned properly and the resistance is between acceptable range for the drive.</p>

Code (hex)	Fault / Aux. code	Cause	What to do
3220	DC link undervoltage	Intermediate circuit DC voltage is not sufficient because of a missing supply phase, blown fuse or fault in the rectifier bridge.	Check supply cabling, fuses and switchgear.
3385	Autophasing	Autophasing routine (see section Autophasing on page 147) has failed.	Try other autophasing modes (see parameter 21.13 Autophasing mode) if possible. Check that the motor ID run has been successfully completed. Check that the motor is not already turning when the autophasing routine starts. Check the setting of parameter 99.03 Motor type is Permanent magnet motor.
3381	Output phase loss Programmable fault: 31.19 Motor phase loss	Motor circuit fault due to missing motor connection (all three phases are not connected).	Connect motor cable.
4110	Control board temperature	Control board temperature is too high.	Check proper cooling of the drive. Check the auxiliary cooling fan.
4210	IGBT overtemperature	Estimated drive IGBT temperature is excessive.	Check ambient conditions. Check air flow and fan operation. Check heatsink fins for dust pick-up. Check motor power against drive power.
4290	Cooling	Drive module temperature is excessive.	Check ambient temperature. If it exceeds 40 °C/104 °F (IP21 frames R4...R9) or if it exceeds 50 °C /122 °F (IP21 frames R1...R9), ensure that load current does not exceed derated load capacity of drive. For all P55 frames, check the derating temperatures. See chapter <i>Technical data</i> , section <i>Derating</i> in the <i>Hardware manual</i> of the drive. Check drive module cooling air flow and fan operation. Check inside of cabinet and heatsink of drive module for dust pick-up. Clean whenever necessary.
42F1	IGBT temperature	Drive IGBT temperature is excessive.	Check ambient conditions. Check air flow and fan operation. Check heatsink fins for dust pick-up. Check motor power against drive power.
4310	Excess temperature	Power unit module temperature is excessive.	Check ambient conditions. Check air flow and fan operation. Check heatsink fins for dust pick-up. Check motor power against drive power. Check the auxiliary code.
	FA	Ambient temperature	
4380	Excess temperature difference	High temperature difference between the IGBTs of different phases.	Check the motor cabling. Check cooling of drive module(s).

Code (hex)	Fault / Aux. code	Cause	What to do
4981	External temperature 1	Measured temperature 1 has exceeded fault limit.	Check the value of parameter 35.02 Measured temperature 1 . Check the cooling of the motor (or other equipment whose temperature is being measured).
4982	External temperature 2	Measured temperature 2 has exceeded fault limit.	Check the value of parameter 35.03 Measured temperature 2 . Check the cooling of the motor (or other equipment whose temperature is being measured).
4990	CPTC-02 not found	CPTC-02 extension module is not detected in option slot 2.	Power down the drive and check that the module is properly inserted in option slot 2. See also <i>CPTC-02 ATEX-certified thermistor protection module, Ex II (2) GD (+L537+Q971) user's manual (3AXD50000030058 [English])</i> .
4991	Safe motor temperature	The CPTC-02 module indicates overtemperature: <ul style="list-style-type: none"> • motor temperature is too high, or • the thermistor is in short-circuit or disconnected 	Check the cooling of the motor. Check the motor load and drive ratings. Check the wiring of the temperature sensor. Repair wiring if faulty. Measure the resistance of the sensor. Replace the sensor if faulty.
5080	Fan	Cooling fan feedback missing.	See A581 Fan (page 192).
5081	Auxiliary fan broken	An auxiliary cooling fan (connected to the fan connectors on the control unit) is stuck or disconnected.	Check the auxiliary code, which identifies the broken fan. Check auxiliary fan(s) and connection(s). Replace fan if faulty. Make sure the front cover of the drive is in place and tightened. If the commissioning of the drive requires that the cover is off, set parameter 31.36 Aux fan fault function temporarily to value <i>No action</i> within two minutes from power-up. Reboot the control unit (using parameter 96.08 Control board boot) or by cycling power.
		0001 Auxiliary fan 1 broken.	
		0002 Auxiliary fan 2 broken.	
5089	SMT circuit malfunction	Fault 4991 Safe motor temperature is generated but drive STO is not activated. Note: If only one STO channel is opened, fault FA81 Safe torque off 1 or FA82 Safe torque off 2 is generated.	Check connection between the relay output of the CPTC-02 module and the STO terminal. Check CPTC-02 module. Replace if faulty. See also <i>CPTC-02 ATEX-certified thermistor protection module, Ex II (2) GD (+L537+Q971) user's manual (3AXD50000030058 [English])</i> .
5090	STO hardware failure	STO hardware diagnostics has detected hardware failure.	Contact your local ABB representative for hardware replacement.

Code (hex)	Fault / Aux. code	Cause	What to do
5091	Safe torque off Programmable fault: 31.22 STO indication run/stop	Safe torque off function is active, ie, safety circuit signal(s) connected to connector STO is broken during start or run.	Check safety circuit connections. For more information, see chapter <i>The Safe torque off function</i> in the <i>Hardware manual</i> of the drive and description of parameter 31.22 STO indication run/stop (page 396). Check the value of parameter 95.04 Control board supply .
5092	PU logic error	Power unit memory has cleared.	Contact your local ABB representative.
5093	Rating ID mismatch	The hardware of the drive does not match the information stored in the memory. This may occur, for example, after a firmware update.	Cycle the power to the drive. You may have to repeat this.
5094	Measurement circuit temperature	Problem with internal temperature measurement of the drive.	Contact your local ABB representative.
5098	I/O communication loss	Internal standard I/O communication failure.	Try resetting the fault or reboot the drive.
50A0	Fan	Cooling fan stuck or disconnected.	Check fan operation and connection. Replace fan if faulty.
5681	PU communication	Communication errors detected between the drive control unit and the power unit.	Check the connection between the drive control unit and the power unit. Check the value of parameter 95.04 Control board supply .
5682	Power unit lost	Connection between the drive control unit and the power unit is lost.	Check the connection between the control unit and the power unit.
5691	Measurement circuit ADC	Measurement circuit fault.	Contact your local ABB representative.
5692	PU board powerfail	Power unit power supply failure.	Contact your local ABB representative.
5693	Measurement circuit DFF	Measurement circuit fault.	Contact your local ABB representative.
5697	Charging feedback	Charging feedback signal missing.	Check the feedback signal coming from the charging system.
5698	Unknown PU fault	The power unit logic has generated a fault which is not known by the software.	Check the logic and software compatibility.
5E1A	Charging circuit failure	Charging circuit is non-operational.	Only for ACQ580-31. Contact your local ABB representative.
6181	FPGA version incompatible	Firmware and FPGA versions are incompatible.	Reboot the control unit (using parameter 96.08 Control board boot) or by cycling power. If the problem persists, contact your local ABB representative
6200	Checksum mismatch Programmable fault: 96.54 Checksum action	The calculated parameter checksum does not match any enabled reference checksum.	See A686 Checksum mismatch (page 193).
6306	FBA A mapping file	Fieldbus adapter A mapping file read error.	Contact your local ABB representative.

Code (hex)	Fault / Aux. code	Cause	What to do
6481	Task overload	Internal fault.	Reboot the control unit (using parameter 96.08 Control board boot) or by cycling power. If the problem persists, contact your local ABB representative
6487	Stack overflow	Internal fault.	Reboot the control unit (using parameter 96.08 Control board boot) or by cycling power. If the problem persists, contact your local ABB representative
64A1	Internal file load	File read error.	Reboot the control unit (using parameter 96.08 Control board boot) or by cycling power. If the problem persists, contact your local ABB representative
64A4	Rating ID fault	Rating ID load error.	Contact your local ABB representative.
64A6	Adaptive program	Error running the adaptive program.	Check the auxiliary code (format XXYY ZZZZ). "XX" specifies the number of the state (00=base program) and "YY" specifies the number of the function block (0000=generic error). "ZZZZ" indicates the problem.
	000A	Program corrupted or block non-existent	Restore the template program or download the program to the drive.
	000C	Required block input missing	Check the inputs of the block.
	000E	Program corrupted or block non-existent	Restore the template program or download the program to the drive.
	0011	Program too large.	Remove blocks until the error stops.
	0012	Program is empty.	Correct the program and download it to the drive.
	001C	A non-existing parameter or block is used in the program.	Edit the program to correct the parameter reference, or to use an existing block.
	001D	Parameter type invalid for selected pin.	Edit the program to correct the parameter reference.
	001E	Output to parameter failed because the parameter was write-protected.	Check the parameter reference in the program. Check for other sources affecting the target parameter.
	0023	Program file incompatible with current firmware version.	Adapt the program to current block library and firmware version.
	0024		
	Other	-	Contact your local ABB representative, quoting the auxiliary code.
64B1	Internal SSW fault	Internal fault.	Reboot the control unit (using parameter 96.08 Control board boot) or by cycling power. If the problem persists, contact your local ABB representative.
64B2	User set fault	Loading of user parameter set failed because <ul style="list-style-type: none"> • requested set does not exist • set is not compatible with control program • drive was switched off during loading. 	Ensure that a valid user parameter set exists. Reload if uncertain.

Code (hex)	Fault / Aux. code	Cause	What to do
64E1	Kernel overload	Operating system error.	Reboot the control unit (using parameter 96.08 Control board boot) or by cycling power. If the problem persists, contact your local ABB representative.
64FF	Fault reset	A fault has been reset from the control panel, Drive composer PC tool, fieldbus or I/O.	Event. Informative only.
6581	Parameter system	Parameter load or save failed.	Try forcing a save using parameter 96.07 Parameter save manually . Retry.
6591	Backup/Restore timeout	During backup creating or restoring operation a control panel or PC tool has failed to communicate with the drive as part this operation.	Check control panel or PC tool communication and if it is still in backup or restore state.
65A1	FBA parameter conflict	The drive does not have a functionality requested by PLC, or requested functionality has not been activated.	Check PLC programming. Check settings of parameter groups 50 Fieldbus adapter (FBA) and 51 FBA A settings .
6681	EFB comm loss Programmable fault: 58.14 Communication loss action	Communication break in embedded fieldbus (EFB) communication.	Check the status of the fieldbus master (online/offline/error etc.). Check cable connections to the EIA-485/X5 terminals 29, 30 and 31 on the control unit.
6682	EFB config file	Embedded fieldbus (EFB) configuration file could not be read.	Contact your local ABB representative.
6683	EFB invalid parameterization	Embedded fieldbus (EFB) parameter settings inconsistent or not compatible with selected protocol.	Check the settings in parameter group 58 Embedded fieldbus .
6684	EFB load fault	Embedded fieldbus (EFB) protocol firmware could not be loaded. Version mismatch between EFB protocol firmware and drive firmware.	Contact your local ABB representative.
6685	EFB fault 2	Fault reserved for the EFB protocol application.	Check the documentation of the protocol.
6686	EFB fault 3	Fault reserved for the EFB protocol application.	Check the documentation of the protocol.
6882	Text 32-bit table overflow	Internal fault.	Reset the fault. Contact your local ABB representative if the fault persists.
6885	Text file overflow	Internal fault.	Reset the fault. Contact your local ABB representative if the fault persists.
7081	Control panel loss Programmable fault: 49.05 Communication loss action	Control panel or PC tool selected as active control location for drive has ceased communicating.	Check PC tool or control panel connection. Check control panel connector. Disconnect and reconnect the control panel.
7085	Incompatible option module	Fieldbus option module not supported.	Replace the module with a supported type.

Code (hex)	Fault / Aux. code	Cause	What to do
7086	AI Overvoltage	An overvoltage has been detected on an analog input. The analog input has temporarily been changed to voltage mode and will be changed back to current mode when the AI signal level is back within acceptable limits.	Check AI signal levels.
7100	Excitation current	Excitation current feedback low or missing	
7121	Motor stall Programmable fault: 31.24 Stall function	Motor is operating in stall region because of, for example, excessive load or insufficient motor power.	Check motor load and drive ratings. Check fault function parameters.
7122	Motor overload	Motor current is too high.	Check for overloaded motor. Adjust the parameters used for the motor overload function (35.51...35.53) and 35.55...35.56 .
7181	Brake resistor	Brake resistor broken or not connected.	Check that a brake resistor has been connected. Check the condition of the brake resistor. Check the dimensioning of the brake resistor.
7183	BR excess temperature	Brake resistor temperature has exceeded fault limit defined by parameter 43.11 Brake resistor fault limit .	Stop drive. Let resistor cool down. Check resistor overload protection function settings (parameter group 43 Brake chopper). Check fault limit setting, parameter 43.11 Brake resistor fault limit . Check that braking cycle meets allowed limits.
7184	Brake resistor wiring	Brake resistor short circuit or brake chopper control fault.	Check brake chopper and brake resistor connection. Ensure brake resistor is not damaged.
7191	BC short circuit	Short circuit in brake chopper IGBT.	Ensure brake resistor is connected and not damaged. Check the electrical specifications of the brake resistor against chapter <i>Resistor braking</i> in the <i>Hardware manual</i> of the drive. Replace brake chopper (if replaceable).
7192	BC IGBT excess temperature	Brake chopper IGBT temperature has exceeded internal fault limit.	Let chopper cool down. Check for excessive ambient temperature. Check for cooling fan failure. Check for obstructions in the air flow. Check resistor overload protection function settings (parameter group 43 Brake chopper). Check that braking cycle meets allowed limits. Check that drive supply AC voltage is not excessive.

Code (hex)	Fault / Aux. code	Cause	What to do
7310	Overspeed	Motor is turning faster than highest allowed speed due to incorrectly set minimum/maximum speed, insufficient braking torque or changes in load when using torque reference.	Check minimum/maximum speed settings, parameters 30.11 Minimum speed and 30.12 Maximum speed . Check adequacy of motor braking torque. Check applicability of torque control. Check need for brake chopper and resistor(s).
73B0	Emergency ramp failed	Emergency stop did not finish within expected time.	Check the settings of parameters 31.32 Emergency ramp supervision and 31.33 Emergency ramp supervision delay . Check the predefined ramp times (23.12...23.13 for mode Off1, 23.23 for mode Off3).
73F0	Overfrequency	Maximum allowed output frequency exceeded.	Check the auxiliary code.
	00FA	Motor is turning faster than the highest allowed frequency due to incorrectly set minimum/maximum frequency or the motor rushes because of too high supply voltage or incorrect supply voltage selection in parameter 95.01 Supply voltage .	Check minimum/maximum frequency settings, parameters 31.13 Minimum frequency and 31.14 Maximum frequency . Check used supply voltage and voltage selection parameter 95.01 Supply voltage .
	Other	-	Contact your local ABB representative, quoting the auxiliary code.
7510	FBA A communication Programmable fault: 50.02 FBA A comm loss func	Cyclical communication between drive and fieldbus adapter module A or between PLC and fieldbus adapter module A is lost.	Check status of fieldbus communication. See user documentation of fieldbus interface. Check settings of parameter groups 50 Fieldbus adapter (FBA) , 51 FBA A settings , 52 FBA A data in and 53 FBA A data out . Check cable connections. Check if communication master is able to communicate.
7580	INU-LSU comm loss Programmable fault: 60.79 INU-LSU comm loss function	DDCS communication between the inverter unit and the supply unit is lost.	Check status of the supply unit (parameter group 06 Control and status words). Check settings of parameter group 60 DDCS communication . Check the corresponding settings in the control program of the supply unit. Check cable connections. If necessary, replace cables.
7583	Line side unit faulted	The supply unit connected to the inverter unit has generated a fault.	The auxiliary code specifies the original fault code in the supply unit control program. You can find the most common auxiliary codes in section Auxiliary codes for the LSU supply unit warnings on page 218 . For full information, see chapter Fault tracing in ACS880 IGBT supply control program firmware manual (3AUA0000131562 [English]).

Code (hex)	Fault / Aux. code	Cause	What to do
7584	LSU charge failed	The supply unit was not ready (ie. the main contactor/breaker could not be closed) within expected time.	Check settings of parameter 94.10 LSU max charging time . Check that the supply unit is enabled, allowed to start, and can be controlled by the inverter unit (eg. not in local control mode).
8001	ULC underload fault	User load curve: Signal has been too long under the underload curve.	See parameter 37.04 ULC underload actions .
8002	ULC overload fault	User load curve: Signal has been too long over the overload curve.	See parameter 37.03 ULC overload actions .
80A0	AI supervision Programmable fault: 12.03 AI supervision function	An analog signal is outside the limits specified for the analog input.	Check signal level at the analog input. Check the auxiliary code. Check the wiring connected to the input. Check the minimum and maximum limits of the input in parameter group 12 Standard AI .
	0001	AI1LessMIN	
	0002	AI1GreaterMAX	
	0003	AI2LessMIN.	
	0004	AI2GreaterMAX	
80B0	Signal supervision 1 (Editable message text) Programmable fault: 32.06 Supervision 1 action	Fault generated by the signal supervision function 1.	Check the source of the fault (parameter 32.07 Supervision 1 signal).
80B1	Signal supervision 2 (Editable message text) Programmable fault: 32.16 Supervision 2 action	Fault generated by the signal supervision function 2.	Check the source of the fault (parameter 32.17 Supervision 2 signal).
80B2	Signal supervision 3 (Editable message text) Programmable fault: 32.26 Supervision 3 action	Fault generated by the signal supervision function 3.	Check the source of the fault (parameter 32.27 Supervision 3 signal).
80B3	Signal supervision 4 (Editable message text) Programmable fault: 32.36 Supervision 4 action	Fault generated by the signal supervision function 4.	Check the source of the fault (parameter 32.37 Supervision 4 signal).
80B4	Signal supervision 5 (Editable message text) Programmable fault: 32.46 Supervision 5 action	Fault generated by the signal supervision function 5.	Check the source of the fault (parameter 32.47 Supervision 5 signal).
80B5	Signal supervision 6 (Editable message text) Programmable fault: 32.56 Supervision 6 action	Fault generated by the signal supervision function 6.	Check the source of the fault (parameter 32.57 Supervision 6 signal).
9081	External fault 1 (Editable message text) Programmable fault: 31.01 External event 1 source , 31.02 External event 1 type	Fault in external device 1.	Check the external device. Check setting of parameter 31.01 External event 1 source .

Code (hex)	Fault / Aux. code	Cause	What to do
9082	External fault 2 (Editable message text) Programmable fault: 31.03 External event 2 source , 31.04 External event 2 type	Fault in external device 2.	Check the external device. Check setting of parameter 31.03 External event 2 source .
9083	External fault 3 (Editable message text) Programmable fault: 31.05 External event 3 source , 31.06 External event 3 type	Fault in external device 3.	Check the external device. Check setting of parameter 31.05 External event 3 source .
9084	External fault 4 (Editable message text) Programmable fault: 31.07 External event 4 source , 31.08 External event 4 type	Fault in external device 4.	Check the external device. Check setting of parameter 31.07 External event 4 source .
9085	External fault 5 (Editable message text) Programmable fault: 31.09 External event 5 source , 31.10 External event 5 type	Fault in external device 5.	Check the external device. Check setting of parameter 31.09 External event 5 source .
D401	Max cleaning fault Programmable fault: 83.35 Cleaning count fault	The maximum number of cleanings are reached in the defined time. The pump cleaning is unable to clean the pump and hence, manual cleaning is required.	Check the pump for blockages. Clean the pump manually if needed. Check parameters 83.35 Cleaning count fault to 83.37 Maximum cleaning count .
D402	High level Programmable fault: 76.93 LC high level action	Water level is reached the high level limit. Level control is unable to control the level for the following reasons: <ul style="list-style-type: none"> • running out of pumping capacity or • analog feedback sensor failure. 	Check the analog level sensor. Check that all pumps are operating normally. Check parameters 76.91 LC high level switch and 76.93 LC high level action .
D403	Low level Programmable fault: 76.92 LC low level action	Water level is reached the low level limit. Level control is unable to control the level for the following reasons: <ul style="list-style-type: none"> • running out of pumping capacity or • analog feedback sensor failure. 	Check the analog level sensor. Check that all pumps are operating normally. Check parameters 76.90 LC low level switch and 76.92 LC low level action .
D404	Running dry Programmable fault: 82.20 Dry run protection	Dry run protection is activated.	Check the pump inlet for sufficient water level. Check dry run protection settings in parameters 82.20 Dry run protection and 82.21 Dry run source .
D405	Pipe fill-timeout Programmable fault: 82.25 Soft pipe fill supervision	Soft pipe fill has reached timeout limit. The PID output is not reached the setpoint after reference ramping is ended and the timeout limit is elapsed.	Check the pipe for possible leakage. See parameter 82.25 Soft pipe fill supervision and 82.26 Time-out limit .

Code (hex)	Fault / Aux. code	Cause	What to do
D406	Maximum flow protection Programmable fault: 80.17 Maximum flow protection	Actual flow is exceeded the defined fault level.	Check the system for leakages. Check flow protection settings in parameters 80.15 Maximum flow , 80.17 Maximum flow protection and 80.19 Flow check delay .
D407	Minimum flow protection Programmable fault: 80.18 Minimum flow protection	Actual flow is below the defined fault level.	Check that the inlet and outlet valves are open. Check flow protection settings in parameters 80.16 Minimum flow , 80.18 Minimum flow protection and 80.19 Flow check delay .
D408	Outlet minimum pressure Programmable fault: 82.30 Outlet minimum pressure protection	The measured outlet pressure is below the defined fault limit.	Check the pump outlet for leakages. Check the configuration of outlet pressure protection. See parameters 82.30 Outlet minimum pressure protection and 82.32 Outlet minimum pressure fault level .
D409	Outlet maximum pressure Programmable fault: 82.35 Outlet maximum pressure protection	The measured outlet pressure is above the defined fault limit.	Check the pump outlet for blockages or closed valve. Check the configuration of outlet pressure protection. See parameters 82.35 Outlet maximum pressure protection and 82.38 Outlet maximum pressure fault level .
D40A	Inlet minimum pressure Programmable fault: 82.40 Inlet minimum pressure protection	The measured inlet pressure is below the defined fault level.	Check the pump inlet for blockages or closed valve. Check the configuration of inlet pressure protection. See parameters 82.40 Inlet minimum pressure protection and 82.42 Inlet minimum pressure fault level .
FA81	Safe torque off 1	Safe torque off function is active, that is, STO circuit 1 is broken.	Check safety circuit connections. For more information, see chapter <i>The Safe torque off function</i> in the <i>Hardware manual</i> of the drive and description of parameter 31.22 STO indication run/stop (page 396). Check the value of parameter 95.04 Control board supply .
FA82	Safe torque off 2	Safe torque off function is active, that is, STO circuit 2 is broken.	
FF61	ID run	Motor ID run was not completed successfully.	Check the nominal motor values in parameter group 99 Motor data . Check that no external control system is connected to the drive. Cycle the power to the drive (and its control unit, if powered separately). Check that no operation limits prevent the completion of the ID run. Restore parameters to default settings and try again. Check that the motor shaft is not locked. Check the auxiliary code. See actions for each code below.

Code (hex)	Fault / Aux. code	Cause	What to do
	0001	Maximum current limit too low.	Check settings of parameters 99.06 Motor nominal current and 30.17 Maximum current . Make sure that $30.17 > 99.06$. Check that the drive is dimensioned correctly according to the motor.
	0002	Maximum speed limit or calculated field weakening point too low.	Check settings of parameters <ul style="list-style-type: none"> • 30.11 Minimum speed • 30.12 Maximum speed • 99.07 Motor nominal voltage • 99.08 Motor nominal frequency • 99.09 Motor nominal speed. Make sure that <ul style="list-style-type: none"> • $30.12 > (0.55 \times 99.09) > (0.50 \times \text{synchronous speed})$ • $30.11 \leq 0$, and • supply voltage $\geq (0.66 \times 99.07)$.
	0003	Maximum torque limit too low.	Check settings of parameter 99.12 Motor nominal torque , and the torque limits in group 30 Limits . Make sure that the maximum torque limit in force is greater than 100%.
	0004	Current measurement calibration did not finish within reasonable time	Contact your local ABB representative.
	0005...0008	Internal error.	Contact your local ABB representative.
	0009	(Asynchronous motors only) Acceleration did not finish within reasonable time.	Contact your local ABB representative.
	000A	(Asynchronous motors only) Deceleration did not finish within reasonable time.	Contact your local ABB representative.
	000B	(Asynchronous motors only) Speed dropped to zero during ID run.	Contact your local ABB representative.
	000C	(Permanent magnet motors only) First acceleration did not finish within reasonable time.	Contact your local ABB representative.
	000D	(Permanent magnet motors only) Second acceleration did not finish within reasonable time.	Contact your local ABB representative.
	000E...0010	Internal error.	Contact your local ABB representative.
	0011	(Synchronous reluctance motors only) Pulse test error.	Contact your local ABB representative.
	0012	Motor too large for advanced standstill ID run.	Check that the motor and drive sizes are compatible. Contact your local ABB representative.

Code (hex)	Fault / Aux. code	Cause	What to do
	0013	(Asynchronous motors only) Motor data error.	Check that the motor nominal value settings in the drive are the same as in the motor nameplate. Contact your local ABB representative.
FF63	STO diagnostics failure.	SW internal malfunction.	Reboot the control unit (using parameter 96.08 Control board boot) or by cycling power.
FF81	FB A force trip	A fault trip command has been received through fieldbus adapter A.	Check the fault information provided by the PLC.
FF8E	EFB force trip	A fault trip command has been received through the embedded fieldbus interface.	Check the fault information provided by the PLC.

Auxiliary codes for the LSU supply unit warnings

For ACQ580-31 and ACQ580-34 only.

The table below lists the auxiliary codes of *AF85 Line side unit warning*. For advanced troubleshooting, see chapter *Fault tracing* in *ACS880 IGBT supply control program firmware manual* (3AUA0000131562 [English]).

Code (hex)	Warning / Aux. code	Cause	What to do
AE01	Overcurrent	Line side current has exceeded internal fault limit.	Check supply voltage. Check that there are no power factor correction capacitors or surge absorbers in supply cable. Check motor load and acceleration times. Check power semiconductors (IGBTs) and current transducers.
AE02	Earth leakage Programmable warning: <i>31.120 LSU earth fault</i>	IGBT supply has detected load unbalance.	Check AC fuses. Check for earth leakages. Check supply cabling. Check power modules. Check there are no power factor correction capacitors or surge absorbers in supply cable. If no earth fault can be detected, contact your local ABB representative.
AE09	DC link overvoltage	Excessive intermediate circuit DC voltage. Note: This warning can be shown only when the IGBT supply unit is not modulating.	Check that parameter <i>95.01 Supply voltage</i> is set according to the supply voltage in use.
AE0A	DC link undervoltage	Intermediate circuit DC voltage is not sufficient due to missing phase in supply voltage, blown fuse or rectifier bridge internal fault. Note: This warning can be shown only when the IGBT supply unit is not modulating.	Check supply cabling, fuses and switchgear. Check that parameter <i>95.01 Supply voltage</i> is set according to the supply voltage in use.
AE0B	DC not charged	The voltage of the intermediate DC circuit has not yet risen to operating level.	Check the input voltage setting in parameter <i>95.01 Supply voltage</i> . Check the input voltage. If the problem persists, contact your local ABB representative.
AE14	Excess temperature	Power unit temperature is excessive.	Check ambient conditions. Check air flow and fan operation. Check heatsink fins for dust pick-up.
AE16	IGBT temperature	IGBT temperature is excessive.	Check ambient conditions. Check air flow and fan operation. Check heatsink fins for dust pick-up.
AE19	Measurement circuit temperature	Problem with internal temperature measurement of the drive.	Contact your local ABB representative.

Code (hex)	Warning / Aux. code	Cause	What to do
AE24	Voltage category unselected	The supply voltage range has not been defined.	Define the supply voltage range (parameter 95.01 Supply voltage).
AE56	INU-LSU comm loss	The communication to the inverter unit is lost.	Check the settings of parameter group 60 DDCS communication .
AE78	Fan	Cooling fan is stuck or disconnected.	Check the auxiliary code in the line-side converter program to identify the fan. Check fan operation and connection. If the problem persists, contact your local ABB representative.
AE80	Auxiliary fan missing	Auxiliary fan is not connected or it is broken.	Contact your local ABB representative.
BE02	MCB maintenance notice	Main circuit breaker should be maintained.	Maintain the main circuit breaker.

Auxiliary codes for the LSU supply unit faults

For ACQ580-31 and ACQ580-34 only.

The table below lists the auxiliary codes of fault **7583 Line side unit faulted**. For advanced troubleshooting, see chapter *Fault tracing* in *ACS880 IGBT supply control program firmware manual* (3AUA0000131562 [English]).

Code (hex)	Fault / Aux. code	Cause	What to do
2E00	Overcurrent	Line side current has exceeded internal fault limit.	Check supply voltage. Check that there are no power factor correction capacitors or surge absorbers in supply cable. Check motor load and acceleration times. Check power semiconductors (IGBTs) and current transducers.
2E01	Earth leakage Programmable warning: 31.120 LSU earth fault	IGBT supply unit has detected an earth fault.	Check AC fuses. Check for earth leakages. Check supply cabling. Check power modules. Check there are no power factor correction capacitors or surge absorbers in supply cable. If no earth fault can be detected, contact your local ABB representative.
2E02	Short circuit	IGBT supply unit has detected short circuit.	Check supply cable. Check there are no power factor correction capacitors or surge absorbers in supply cable. After correcting the cause of the fault, reboot the control unit (using parameter 96.108 LSU control board boot) or by cycling power.
3E00	Input phase loss Programmable warning: 31.121 LSU supply phase loss	Input phase loss detected by the IGBT bridge.	Check the AC fuses. Check for input power supply imbalance.
3E04	DC link overvoltage	Excessive intermediate circuit DC voltage.	Check that parameter 95.01 Supply voltage is set according to the supply voltage in use. Check that parameter 30.30 Overvoltage control is enabled.
3E05	DC link undervoltage	Intermediate circuit DC voltage is not sufficient because of a missing supply phase or blown fuse.	Check supply cabling, fuses and switchgear. Check that parameter 95.01 Supply voltage is set according to the supply voltage in use.
4E02	IGBT temperature	IGBT temperature is excessive.	Check ambient conditions. Check air flow and fan operation. Check heatsink fins for dust pick-up.

Code (hex)	Fault / Aux. code	Cause	What to do
5E05	Rating ID mismatch	The hardware of the supply unit does not match the information stored in the memory unit. This may occur eg, after a firmware update or memory unit replacement.	Cycle the power to the supply unit. If the control unit is externally powered, reboot the control unit (using parameter 96.108 LSU control board boot) or by cycling its power. If the problem persists, contact your local ABB representative.
5E06	Main contactor fault	Control program does not receive main contactor on acknowledgement. Main contactor / main breaker is not functioning properly, or there is a loose / bad connection.	Check main contactor / main breaker control circuit wiring. Contact your local ABB representative.
5E08	Power unit lost	Connection between the control unit and power unit is lost.	Contact your local ABB representative.
5E09	PU board powerfail	Power unit power supply failure.	Contact your local ABB representative.
5E10	Charging feedback	Charging feedback signal missing.	Check charge contactor control circuit wiring. Contact your local ABB representative.
5E14	Measurement circuit temperature	Problem with internal temperature measurement of the drive.	Contact your local ABB representative.
7E11	DDCS controller comm loss	DDCS communication between supply unit and inverter unit has been lost.	Check the settings of parameter group 60 DDCS communication .



Fieldbus control through the embedded fieldbus interface (EFB)

What this chapter contains

The chapter describes how the drive can be controlled by external devices over a communication network (fieldbus) using the embedded fieldbus interface.

System overview

The drive can be connected to an external control system through a communication link using either a fieldbus adapter or the embedded fieldbus interface.

The embedded fieldbus interface supports the Modbus RTU protocol. The drive control program can handle 10 Modbus registers in a 10-millisecond time level. For example, if the drive receives a request to read 20 registers, it will start its response within 22 ms of receiving the request – 20 ms for processing the request and 2 ms overhead for handling the bus. The actual response time depends on other factors as well, such as the baud rate (a parameter setting in the drive).

The drive can be set to receive all of its control information through the fieldbus interface, or the control can be distributed between the embedded fieldbus interface and other available sources, for example, digital and analog inputs.

Connecting the drive to the fieldbus

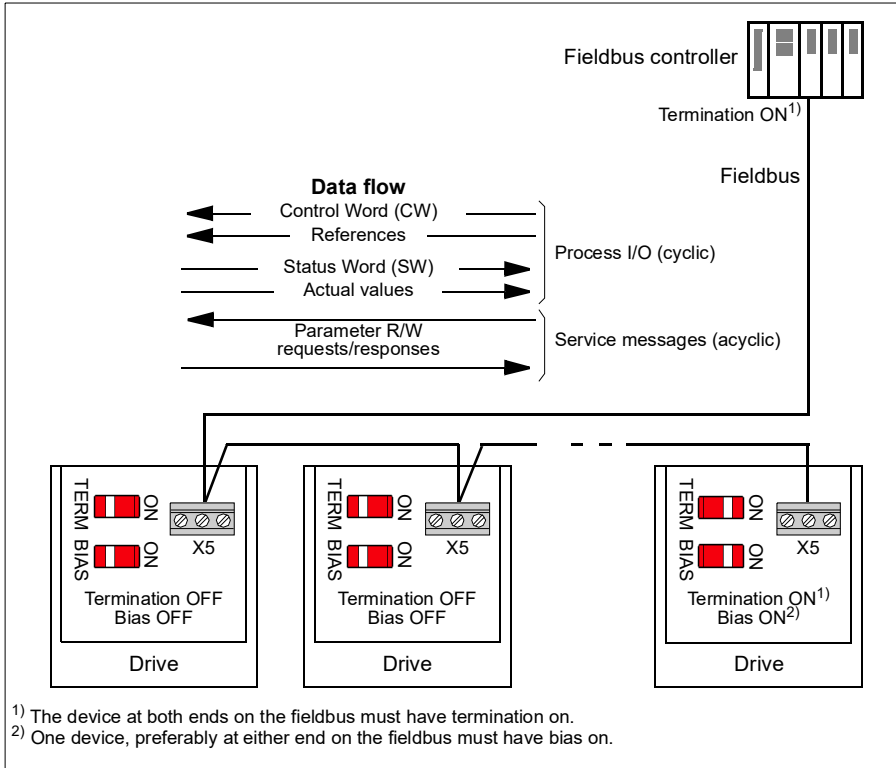

Connect terminal block X5 with B+, A- and DGND terminals on the control unit of the drive to the fieldbus. The connection diagram is shown below.

Use preferably three conductors and a shield for the connection.

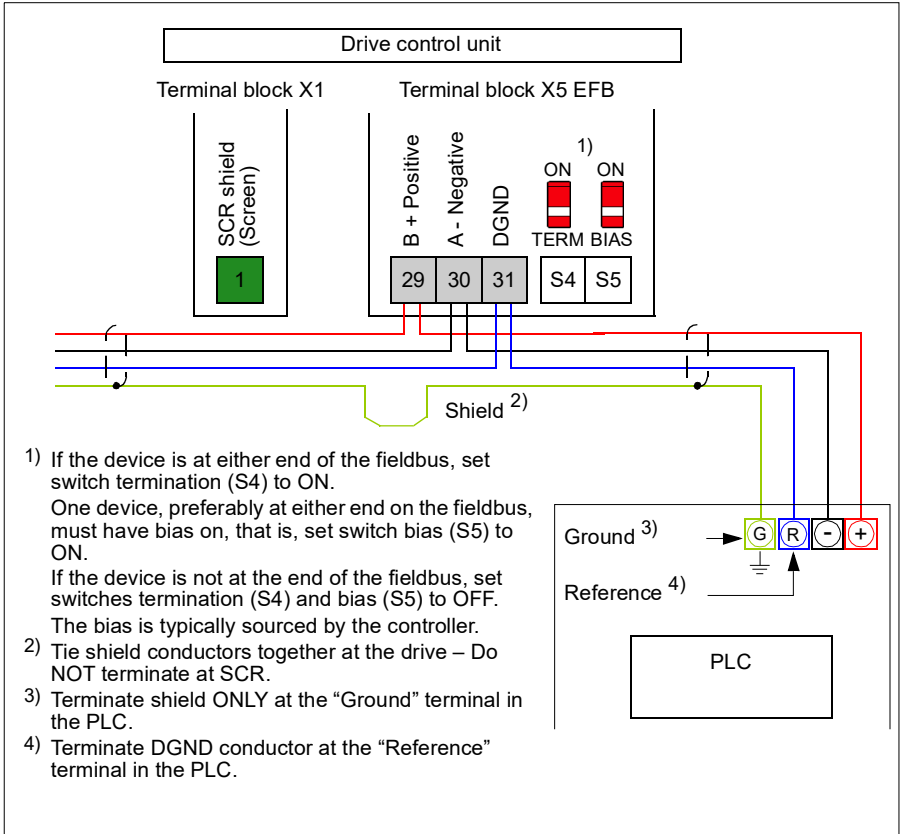

Setting up the embedded fieldbus interface

Set the drive up for the embedded fieldbus communication with the parameters shown in the table below. The **Setting for fieldbus control** column gives either the value to use or the default value. The **Function/Information** column gives a description of the parameter.

Parameter	Setting for fieldbus control	Function/Information
COMMUNICATION INITIALIZATION		
58.01 <i>Protocol enable</i>	<i>Modbus RTU</i>	Initializes embedded fieldbus communication.
EMBEDDED MODBUS CONFIGURATION		
58.03 <i>Node address</i>	1 (default)	Node address. There must be no two nodes with the same node address online.
58.04 <i>Baud rate</i>	<i>19.2 kbps</i> (default)	Defines the communication speed of the link. Use the same setting as in the master station.
58.05 <i>Parity</i>	<i>8 EVEN 1</i> (default)	Selects the parity and stop bit setting. Use the same setting as in the master station.
58.14 <i>Communication loss action</i>	<i>No action</i> (default)	Defines the action taken when a communication loss is detected.
58.15 <i>Communication loss mode</i>	<i>Cw / Ref1 / Ref2</i> (default)	Enables/disables communication loss monitoring and defines the means for resetting the counter of the communication loss delay.
58.16 <i>Communication loss time</i>	30.0 s (default)	Defines the timeout limit for the communication monitoring.
58.17 <i>Transmit delay</i>	0 ms (default)	Defines a response delay for the drive.
58.25 <i>Control profile</i>	<i>ABB Drives</i> (default)	Selects the control profile used by the drive. See section Basics of the embedded fieldbus interface (page 229).
58.26 <i>EFB ref1 type</i> 58.27 <i>EFB ref2 type</i>	<i>Speed or frequency</i> (default for 58.26), <i>Transparent, General, Transparent</i> (default for 58.27) <i>Speed, Frequency</i>	Defines the types of fieldbus references 1 and 2. The scaling for each reference type is defined by parameters 46.01 ... 46.03 . With the <i>Speed or frequency</i> setting, the type is selected automatically according to the currently active drive control mode.
58.28 <i>EFB act1 type</i> 58.29 <i>EFB act2 type</i>	<i>Speed or frequency</i> (default for 58.28), <i>Transparent</i> (default for 58.29), <i>General, Speed, Frequency</i>	Defines the types of actual values 1 and 2. The scaling for each actual value type is defined by parameters 46.01 ... 46.03 . With the <i>Speed or frequency</i> setting, the type is selected automatically according to the currently active drive control mode.

Parameter	Setting for fieldbus control	Function/Information
58.31 <i>EFB act1</i> 58.32 <i>transparent source</i> <i>EFB act2</i> <i>transparent source</i>	<i>Not selected</i>	Defines the source of actual values 1 and 2 when the <i>58.26 EFB ref1 type</i> (<i>58.27 EFB ref2 type</i>) is set to <i>Transparent</i> .
58.33 <i>Addressing mode</i>	<i>Mode 0</i> (default)	Defines the mapping between parameters and holding registers in the 400001...465536 (100...65535) Modbus register range.
58.34 <i>Word order</i>	<i>LO-HI</i> (default)	Defines the order of the data words in the Modbus message frame.
58.101 <i>Data I/O 1</i> ... 58.114 <i>Data I/O 14</i>	For example, the default settings (I/Os 1...6 contain the control word, the status word, two references and two actual values) <i>RO/DIO control word, AO1 data storage, AO2 data storage, Feedback data storage, Setpoint data storage</i>	Defines the address of the drive parameter which the Modbus master accesses when it reads from or writes to the register address corresponding to Modbus In/Out parameters. Select the parameters that you want to read or write through the Modbus I/O words. These settings write the incoming data into storage parameters <i>10.99 RO/DIO control word, 13.91 AO1 data storage, 13.92 AO2 data storage, 40.91 Feedback data storage</i> or <i>40.92 Setpoint data storage</i> .
58.06 <i>Communication control</i>	<i>Refresh settings</i>	Validates the settings of the configuration parameters.

The new settings will take effect when the drive is powered up the next time, or when they are validated by parameter *58.06 Communication control (Refresh settings)*.

Setting the drive control parameters

After the embedded fieldbus interface has been set up, check and adjust the drive control parameters listed in the table below. The **Setting for fieldbus control** column gives the value or values to use when the embedded fieldbus signal is the desired source or destination for that particular drive control signal. The **Function/Information** column gives a description of the parameter.

Parameter	Setting for fieldbus control	Function/Information
CONTROL COMMAND SOURCE SELECTION		
<i>20.01 Ext1 commands</i>	<i>Embedded fieldbus</i>	Selects fieldbus as the source for the start and stop commands when EXT1 is selected as the active control location.

Parameter	Setting for fieldbus control	Function/Information
20.06 Ext2 commands	<i>Embedded fieldbus</i>	Selects fieldbus as the source for the start and stop commands when EXT2 is selected as the active control location.

SPEED REFERENCE SELECTION		
22.11 Ext1 speed ref1	<i>EFB ref1</i>	Selects a reference received through the embedded fieldbus interface as speed reference 1.
22.18 Ext2 speed ref1	<i>EFB ref1</i>	Selects a reference received through the embedded fieldbus interface as speed reference 2.

FREQUENCY REFERENCE SELECTION		
28.11 Ext1 frequency ref1	<i>EFB ref1</i>	Selects a reference received through the embedded fieldbus interface as frequency reference 1.
28.15 Ext2 frequency ref1	<i>EFB ref1</i>	Selects a reference received through the embedded fieldbus interface as frequency reference 2.

OTHER SELECTIONS		
EFB references can be selected as the source at virtually any signal selector parameter by selecting <i>Other</i> , then either 03.09 EFB reference 1 or 03.10 EFB reference 2 .		

SYSTEM CONTROL INPUTS		
96.07 Parameter save manually	<i>Save</i> (reverts to <i>Done</i>)	Saves parameter value changes (including those made through fieldbus control) to permanent memory.

Basics of the embedded fieldbus interface

The cyclic communication between a fieldbus system and the drive consists of 16-bit data words or 32-bit data words (with a transparent control profile).

The diagram below illustrates the operation of the embedded fieldbus interface. The signals transferred in the cyclic communication are explained further below the diagram.

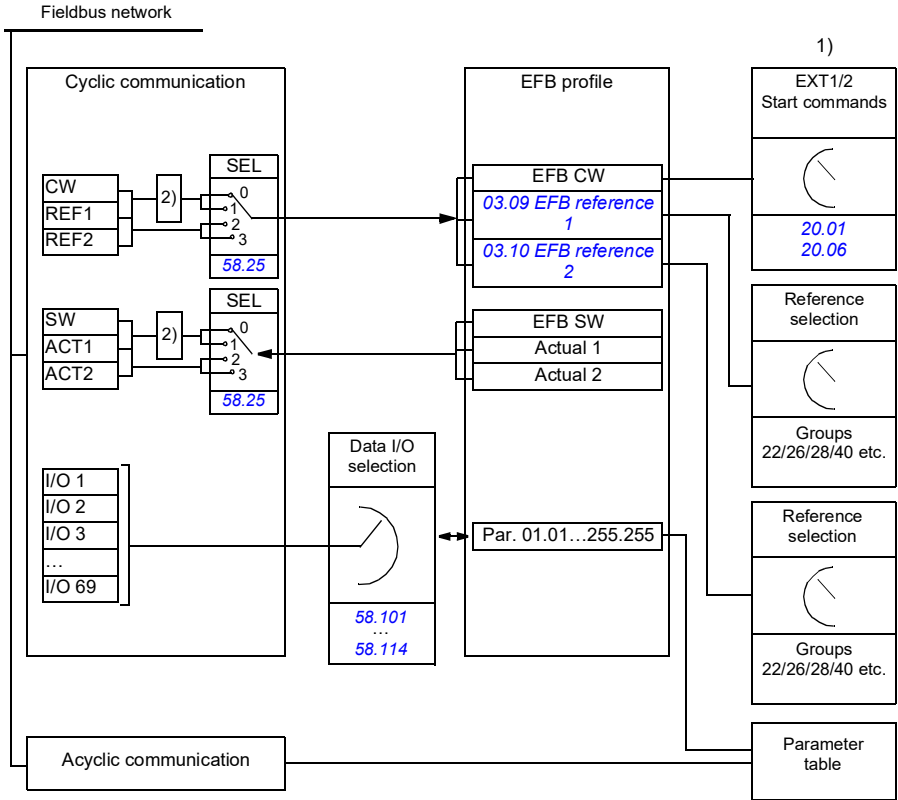

1. See also other parameters which can be controlled through fieldbus.
2. Data conversion if parameter 58.25 Control profile is set to ABB Drives. See section About the control profiles (page 232).

■ Control word and Status word

The Control Word (CW) is a 16-bit or 32-bit packed boolean word. It is the principal means of controlling the drive from a fieldbus system. The CW is sent by the fieldbus controller to the drive. With drive parameters, the user selects the EFB CW as the source of drive control commands (such as start/stop, emergency stop, selection between external control locations EXT1 and EXT2, or fault reset). The drive switches between its states according to the bit-coded instructions of the CW.

The fieldbus CW is either written to the drive as it is or the data is converted. See section [About the control profiles](#) (page 232).

The fieldbus Status Word (SW) is a 16-bit or 32-bit packed boolean word. It contains status information from the drive to the fieldbus controller. The drive SW is either written to the fieldbus SW as it is or the data is converted. See section [About the control profiles](#) (page 232).

■ References

EFB references 1 and 2 are 16-bit or 32-bit signed integers. The contents of each reference word can be used as the source of virtually any signal, such as the speed, frequency or process reference. In embedded fieldbus communication, references 1 and 2 are displayed by [03.09 EFB reference 1](#) and [03.10 EFB reference 2](#) respectively. Whether the references are scaled or not depends on the settings of [58.26 EFB ref1 type](#) and [58.27 EFB ref2 type](#). See section [About the control profiles](#) (page 232).

8

■ Actual values

Fieldbus actual signals (ACT1 and ACT2) are 16-bit or 32-bit signed integers. They convey selected drive parameter values from the drive to the master. Whether the actual values are scaled or not depends on the settings of [58.28 EFB act1 type](#) and [58.29 EFB act2 type](#). See section [About the control profiles](#) (page 232).

■ Data input/outputs

Data input/outputs are 16-bit or 32-bit words containing selected drive parameter values. Parameters [58.101 Data I/O 1 ... 58.114 Data I/O 14](#) define the addresses from which the master either reads data (input) or to which it writes data (output).

■ Register addressing

The address field of Modbus requests for accessing holding registers is 16 bits. This allows the Modbus protocol to support addressing of 65536 holding registers.

Historically, Modbus master devices used 5-digit decimal addresses from 40001 to 49999 to represent holding register addresses. The 5-digit decimal addressing limited to 9999 the number of holding registers that could be addressed.

Modern Modbus master devices typically provide a means to access the full range of 65536 Modbus holding registers. One of these methods is to use 6-digit decimal addresses from 400001 to 465536. This manual uses 6-digit decimal addressing to represent Modbus holding register addresses.

Modbus master devices that are limited to the 5-digit decimal addressing may still access registers 400001 to 409999 by using 5-digit decimal addresses 40001 to 49999. Registers 410000-465536 are inaccessible to these masters.

See parameter [58.33 Addressing mode](#).

Note: Register addresses of 32-bit parameters cannot be accessed by using 5-digit register numbers.

About the control profiles

A control profile defines the rules for data transfer between the drive and the fieldbus master, for example:

- if packed boolean words are converted and how
- if signal values are scaled and how
- how drive register addresses are mapped for the fieldbus master.

You can configure the drive to receive and send messages according to one of the two profiles:

- *ABB Drives*
- *DCU Profile*.

For the ABB Drives profile, the embedded fieldbus interface of the drive converts the fieldbus data to and from the native data used in the drive. The DCU Profile involves no data conversion or scaling. The figure below illustrates the effect of the profile selection.

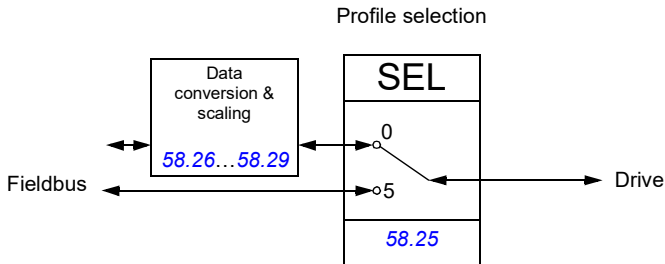

Control profile selection with parameter *58.25 Control profile* is:

- (0) *ABB Drives*
- (5) *DCU Profile*.

Control Word

■ Control Word for the ABB Drives profile

The table below shows the contents of the fieldbus Control Word for the ABB Drives control profile. The embedded fieldbus interface converts this word to the form in which it is used in the drive. The upper case boldface text refers to the states shown in *State transition diagram for the ABB Drives profile* on page 240.

Bit	Name	Value	STATE/Description
0	OFF1_ CONTROL	1	Proceed to READY TO OPERATE.
		0	Stop along currently active deceleration ramp. Proceed to OFF1 ACTIVE ; proceed to READY TO SWITCH ON unless other interlocks (OFF2, OFF3) are active.
1	OFF2_ CONTROL	1	Continue operation (OFF2 inactive).
		0	Emergency OFF, coast to stop. Proceed to OFF2 ACTIVE , proceed to SWITCH-ON INHIBITED .
2	OFF3_ CONTROL	1	Continue operation (OFF3 inactive).
		0	Emergency stop, stop within time defined by drive parameter. Proceed to OFF3 ACTIVE ; proceed to SWITCH-ON INHIBITED . Warning: Ensure that the motor and driven machine can be stopped using this stop mode.
3	INHIBIT_ OPERATION	1	Proceed to OPERATION ENABLED . Note: Run permissive signal must be active; see the drive documentation. If the drive is set to receive the Run permissive signal from the fieldbus, this bit activates the signal.
		0	Inhibit operation. Proceed to OPERATION INHIBITED .
4	RAMP_OUT_ ZERO	1	Normal operation. Proceed to RAMP FUNCTION GENERATOR: OUTPUT ENABLED .
		0	Force Ramp Function Generator output to zero. Drive ramps to stop (current and DC voltage limits in force).
5	RAMP_HOLD	1	Enable ramp function. Proceed to RAMP FUNCTION GENERATOR: ACCELERATOR ENABLED .
		0	Halt ramping (Ramp Function Generator output held).
6	RAMP_IN_ ZERO	1	Normal operation. Proceed to OPERATING . Note: This bit is effective only if the fieldbus interface is set as the source for this signal by drive parameters.
		0	Force Ramp Function Generator input to zero.
7	RESET	0=>1	Fault reset if an active fault exists. Proceed to SWITCH-ON INHIBITED . Note: This bit is effective only if the fieldbus interface is set as the source for this signal by drive parameters.
		0	Continue normal operation.

Bit	Name	Value	STATE/Description
8	Reserved		
9	Reserved		
10	REMOTE_CMD	1	Fieldbus control d.
		0	Control Word \neq 0 or Reference \neq 0: Retain last Control Word and Reference. Control Word = 0 and Reference = 0: Fieldbus control d. Reference and deceleration/acceleration ramp are locked.
11	EXT_CTRL_LOC	1	Select External Control Location EXT2. Effective if the control location is parameterized to be selected from the fieldbus.
		0	Select External Control Location EXT1. Effective if the control location is parameterized to be selected from the fieldbus.
12	USER_0		Writable control bits that can be combined with drive logic for application-specific functionality.
13	USER_1		
14	USER_2		
15	USER_3		

■ Control Word for the DCU Profile

The embedded fieldbus interface writes the fieldbus Control Word as is to the drive Control Word bits 0 to 15. Bits 16 to 32 of the drive Control Word are not in use.

8

Bit	Name	Value	State/Description
0	STOP	1	Stop according to the Stop Mode parameter or the stop mode request bits (bits 7...9).
		0	(no op)
1	START	1	Start the drive.
		0	(no op)
2	REVERSE	1	Reverse direction of motor rotation.
		0	Direction of motor rotation depends on the sign of reference: Positive reference: Forward Negative reference: Reverse.
3	Reserved		
4	RESET	0=>1	Fault reset if an active fault exists.
		0	(no op)
5	EXT2	1	Select External control location EXT2. Effective if the control location is parameterized to be selected from the fieldbus.
		0	Select External control location EXT1. Effective if the control location is parameterized to be selected from the fieldbus.

Bit	Name	Value	State/Description
6	RUN_DISABLE	1	Run disable. If the drive is set to receive the run enable signal from the fieldbus, this bit deactivates the signal.
		0	Run enable. If the drive is set to receive the run enable signal from the fieldbus, this bit activates the signal.
7	STOPMODE_RAMP	1	Normal ramp stop mode
		0	(no op) Default to parameter stop mode if bits 7...9 are all 0.
8	STOPMODE_EMERGENCY_RAMP	1	Emergency ramp stop mode.
		0	(no op) Default to parameter stop mode if bits 7...9 are all 0.
9	STOPMODE_COAST	1	Coast stop mode.
		0	(no op) Default to parameter stop mode if bits 7...9 are all 0.
10	RAMP_PAIR_2	1	(no op)
		0	Select ramp set 1 (Acceleration time 1 / Deceleration time 1).
11	RAMP_OUT_ZERO	1	Force Ramp Function Generator output to zero. Drive ramps to stop (current and DC voltage limits in force).
		0	Normal operation.
12	RAMP_HOLD	1	Halt ramping (Ramp Function Generator output held).
		0	Normal operation.
13	RAMP_IN_ZERO	1	Force Ramp Function Generator input to zero.
		0	Normal operation.
14	REQ_LOCAL_LOCK	1	Drive does not switch to local control mode (see parameter 19.18 HAND/OFF disable source).
		0	Drive can switch between local and external control modes.
16	FB_LOCAL_CTL	1	Local mode for control from the fieldbus is requested. Steal control from the active source.
		0	(no op)
17	FB_LOCAL_REF	1	Local mode for reference from the fieldbus is requested. Steal reference from the active source.
		0	(no op)
18	Reserved for RUN_DISABLE_1		Not yet implemented.
19	Reserved		
20	Reserved		
21	Reserved		

Bit	Name	Value	State/Description
22	USER_0		Writable control bits that can be combined with drive logic for application-specific functionality.
23	USER_1		
24	USER_2		
25	USER_3		
26... 31	Reserved		

Status Word

■ Status Word for the ABB Drives profile

The table below shows the fieldbus Status Word for the ABB Drives control profile. The embedded fieldbus interface converts the drive Status Word into this form for the fieldbus. The upper case boldface text refers to the states shown in [State transition diagram for the ABB Drives profile](#) on page 240.

Bit	Name	Value	STATE/Description
0	RDY_ON	1	READY TO SWITCH ON.
		0	NOT READY TO SWITCH ON.
1	RDY_RUN	1	READY TO OPERATE.
		0	OFF1 ACTIVE.
2	RDY_REF	1	OPERATION ENABLED.
		0	OPERATION INHIBITED.
3	TRIPPED	1	FAULT.
		0	No fault.
4	OFF_2_STATUS	1	OFF2 inactive.
		0	OFF2 ACTIVE.
5	OFF_3_STATUS	1	OFF3 inactive.
		0	OFF3 ACTIVE.
6	SWC_ON_INHIB	1	SWITCH-ON INHIBITED.
		0	–
7	ALARM	1	Warning/Alarm.
		0	No warning/alarm.
8	AT_SETPOINT	1	OPERATING. Actual value equals Reference (is within tolerance limits, for example, in speed control, speed error is 10% max. of nominal motor speed).
		0	Actual value differs from Reference (is outside tolerance limits).
9	REMOTE	1	Drive control location: REMOTE (EXT1 or EXT2).
		0	Drive control location: LOCAL.
10	ABOVE_LIMIT	1	Actual frequency or speed equals or exceeds supervision limit (set by drive parameter). Valid in both directions of rotation. Set by drive parameters 46.31 Above speed limit and 46.32 Above frequency limit . These parameters are indicated by bit 10 of 06.11 Main status word .
		0	Actual frequency or speed within supervision limit.

Bit	Name	Value	STATE/Description
11	USER_0		Status bits that can be combined with drive logic for application-specific functionality.
12	USER_1		
13	USER_2		
14	USER_3		
15	Reserved		

■ Status Word for the DCU Profile

The embedded fieldbus interface writes the drive Status Word bits 0 to 15 to the fieldbus Status Word as is.

Bit	Name	Value	State/Description
0	READY	1	Drive is ready to receive the start command.
		0	Drive is not ready.
1	ENABLED	1	Run permissive and all start interlocks are active.
		0	Run permissive and all start interlocks are not active.
2	STARTED	1	Drive has received start command.
		0	Drive has not received start command.
3	RUNNING	1	Drive is modulating.
		0	Drive is not modulating.
4	ZERO_SPEED	1	Drive is at zero speed.
		0	Drive is not at zero speed.
5	ACCELERATING	1	Drive speed is increasing.
		0	Drive speed is not increasing.
6	DECELERATING	1	Drive speed is decreasing.
		0	Drive speed is not decreasing.
7	AT_SETPOINT	1	Drive is at setpoint.
		0	Drive is not at setpoint.
8	LIMIT	1	Drive operation is limited.
		0	Drive operation is not limited.
9	SUPERVISION	1	Actual value (speed, frequency or torque) is above a limit. Limit is set with parameters 46.31 Above speed limit and 46.32 Above frequency limit .
		0	Actual value (speed, frequency or torque) is within limits.
10	REVERSE_REF	1	Drive reference is in the reverse direction.
		0	Drive reference is in the forward direction
11	REVERSE_ACT	1	Drive is running in the reverse direction
		0	Drive is running in the forward direction

Bit	Name	Value	State/Description
12	PANEL_LOCAL	1	Control panel/keypad (or PC tool) is in local control mode.
		0	Control panel/keypad (or PC tool) is not in local control mode.
13	FIELDBUS_LOCAL	1	Fieldbus is in local control mode.
		0	Fieldbus is not in local control mode.
14	EXT2_ACT	1	External control location EXT2 is active.
		0	External control location EXT1 is active.
15	FAULT	1	Drive is faulted.
		0	Drive is not faulted.
16	ALARM	1	Warning/Alarm is active.
		0	No warning/alarm.
17	Reserved		
18	DIRLOCK	1	Direction lock is ON. (Direction change is locked out.)
		0	Direction lock is OFF.
19	LOCALLOCK	1	Local mode lock is ON. (Local mode is locked out.)
		0	Local mode lock is OFF.
20	CTL_MODE	1	Vector motor control mode is active.
		0	Scalar motor control mode is active.
21	Reserved		
22	USER_0		Status bits that can be combined with drive logic for application-specific functionality.
23	USER_1		
24	USER_2		
25	USER_3		
26	REQ_CTL	1	Control has been granted to this channel.
		0	Control has not been granted to this channel.
27	REQ_REF1	1	Reference 1 has been requested in this channel.
		0	Reference 1 has not been requested in this channel.
28	REQ_REF2	1	Reference 2 has been requested in this channel.
		0	Reference 2 has not been requested in this channel.
29... 31	Reserved		

State transition diagrams

■ State transition diagram for the ABB Drives profile

The diagram below shows the state transitions in the drive when the drive is using the ABB Drives profile and the drive is configured to follow the commands of the control word from the embedded fieldbus interface. The upper case texts refer to the states which are used in the tables representing the fieldbus Control and Status words. See sections [Control Word for the ABB Drives profile](#) on page 233 and [Status Word for the ABB Drives profile](#) on page 237.

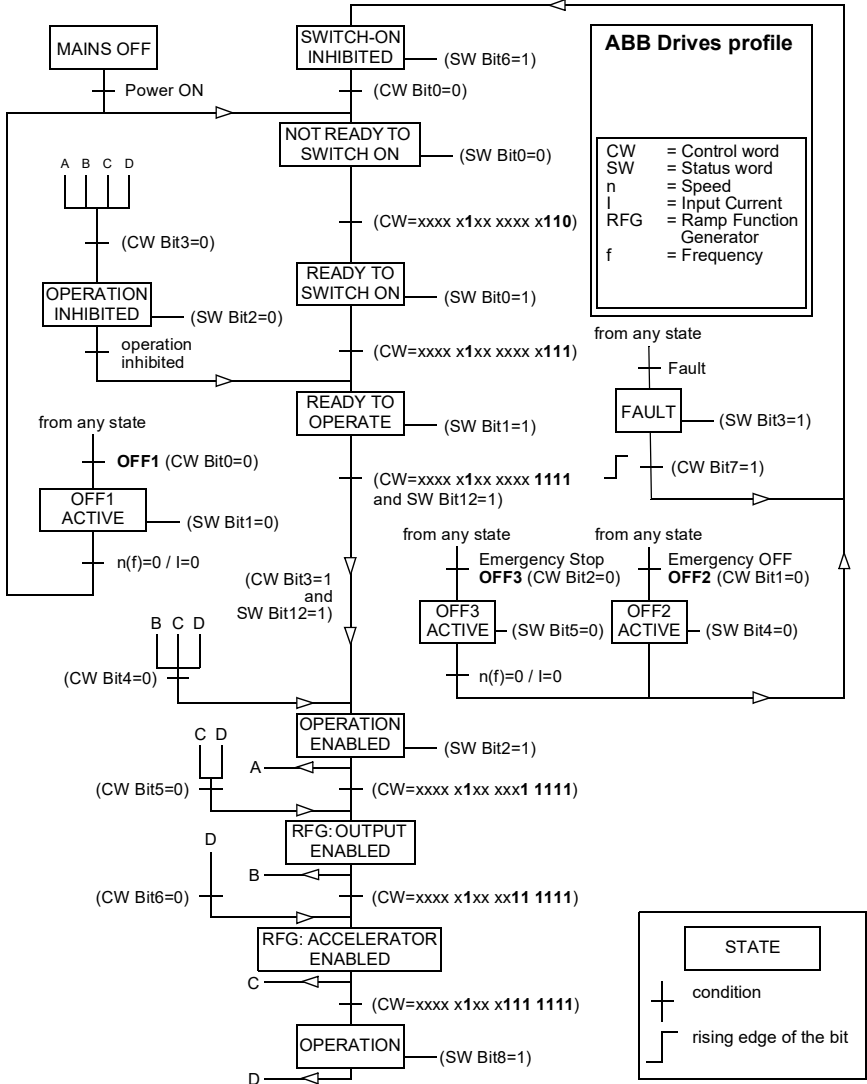

The start and stop sequences are given below.

Control word:

Start:

- 1142 (476h) → NOT READY TO SWITCH ON
- If MSW bit 0 = 1 then
 - 1150 (47Eh) → READY TO SWITCH ON (Stopped)
 - 1151 (47Fh) → OPERATION (Running)

Stop:

- 1143 (477h) = Stop according to [21.03 Stop mode](#) (Preferred)
- 1150 (47Eh) = OFF1 ramp stop (Note: uninterruptable ramp stop)
- 1149 (47Dh) = OFF2 emergency coast to stop
- 1147 (47Bh) = OFF3 emergency ramp stop

Fault reset:

- Rising edge of MCW bit 7

Start after STO:

- If [31.22 STO indication run/stop](#) is not Fault/ Fault, check that [06.18 Start inhibit status word](#), bit 7 STO = 0 before giving a start command.

References

References for the ABB Drives profile and DCU Profile

The ABB Drives profile supports the use of two references, EFB reference 1 and EFB reference 2. The references are 16-bit words each containing a sign bit and a 15-bit integer. A negative reference is formed by calculating the two's complement from the corresponding positive reference.

The references are scaled as defined by parameters [46.01...46.04](#); which scaling is in use depends on the setting of [58.26 EFB ref1 type](#) and [58.27 EFB ref2 type](#).

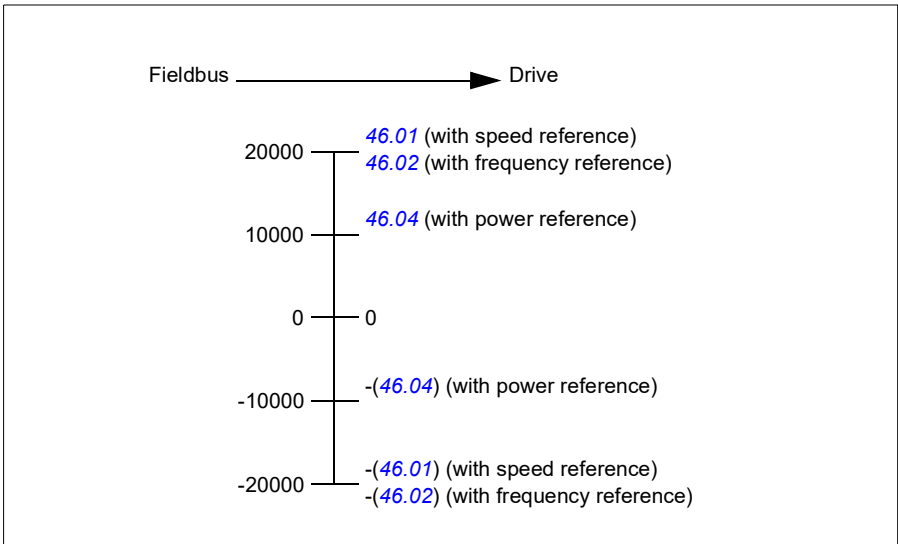

The scaled references are shown by parameters [03.09 EFB reference 1](#) and [03.10 EFB reference 2](#).

Actual values

Actual values for the ABB Drives profile and DCU Profile

The ABB Drives profile supports the use of two fieldbus actual values, ACT1 and ACT2. The actual values are 16-bit words each containing a sign bit and a 15-bit integer. A negative value is formed by calculating the two's complement from the corresponding positive value.

The actual values are scaled as defined by parameters [46.01...46.04](#); which scaling is in use depends on the setting of parameters [58.28 EFB act1 type](#) and [58.29 EFB act2 type](#).

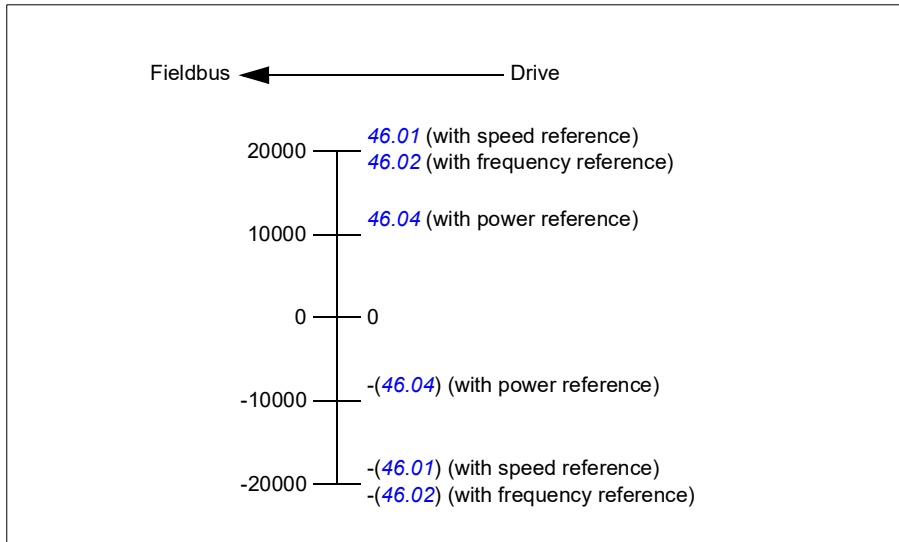

Modbus holding register addresses

■ Modbus holding register addresses for the ABB Drives profile and DCU Profile

The table below shows the default Modbus holding register addresses for the drive data with the ABB Drives profile. This profile provides a converted 16-bit access to the drive data.

Note: Only the 16 least significant bits of the drive's 32-bit Control and Status Words can be accessed.

Note: Bits 16 through 32 of the DCU Control/Status word are not in use if 16-bit control/status word is used with the DCU Profile.

Register address	Register data (16-bit words)
400001	Default: Control word (<i>CW 16bit</i>). See sections <i>Control Word for the ABB Drives profile</i> (page 233) and <i>Control Word for the DCU Profile</i> (page 234). The selection can be changed using parameter <i>58.101 Data I/O 1</i> .
400002	Default: Reference 1 (<i>Ref1 16bit</i>). The selection can be changed using parameter <i>58.102 Data I/O 2</i> .
400003	Default: Reference 2 (<i>Ref2 16bit</i>). The selection can be changed using parameter <i>58.103 Data I/O 3</i> .
400004	Default: Status Word (<i>SW 16bit</i>). See sections <i>Status Word for the ABB Drives profile</i> (page 237) and <i>Status Word for the DCU Profile</i> (page 238). The selection can be changed using parameter <i>58.104 Data I/O 4</i> .
400005	Default: Actual value 1 (<i>Act1 16bit</i>). The selection can be changed using parameter <i>58.105 Data I/O 5</i> .
400006	Actual value 2 (<i>Act2 16bit</i>). The selection can be changed using parameter <i>58.106 Data I/O 6</i> .
400007...400014	Data in/out 7...14. Selected by parameters <i>58.107 Data I/O 7...58.114 Data I/O 14</i> .
400015...400089	Unused
400090...400100	Error code access. See section <i>Error code registers (holding registers 400090...400100)</i> (page 252).
400101...465536	Parameter read/write. Parameters are mapped to register addresses according to parameter <i>58.33 Addressing mode</i> .

Modbus function codes

The table below shows the Modbus function codes supported by the embedded fieldbus interface.

Code	Function name	Description
01h	Read Coils	Reads the 0/1 status of coils (0X references).
02h	Read Discrete Inputs	Reads the 0/1 status of discrete inputs (1X references).
03h	Read Holding Registers	Reads the binary contents of holding registers (4X references).
05h	Write Single Coil	Forces a single coil (0X reference) to 0 or 1.
06h	Write Single Register	Writes a single holding register (4X reference).
08h	Diagnostics	<p>Provides a series of tests for checking the communication, or for checking various internal error conditions.</p> <p>Supported subcodes:</p> <ul style="list-style-type: none"> • 00h Return Query Data: Echo/loopback test. • 01h Restart Comm Option: Restarts and initializes the EFB, clears communications event counters. • 04h Force Listen Only Mode • 0Ah Clear Counters and Diagnostic Register • 0Bh Return Bus Message Count • 0Ch Return Bus Comm. Error Count • 0Dh Return Bus Exception Error Count • 0Eh Return Slave Message Count • 0Fh Return Slave No Response Count • 10h Return Slave NAK (negative acknowledge) Count • 11h Return Slave Busy Count • 12h Return Bus Character Overrun Count • 14h Clear Overrun Counter and Flag
0Bh	Get Comm Event Counter	Returns a status word and an event count.
0Fh	Write Multiple Coils	Forces a sequence of coils (0X references) to 0 or 1.
10h	Write Multiple Registers	Writes the contents of a contiguous block of holding registers (4X references).
16h	Mask Write Register	Modifies the contents of a 4X register using a combination of an AND mask, an OR mask, and the register's current contents.

Code	Function name	Description
17h	Read/Write Multiple Registers	Writes the contents of a contiguous block of 4X registers, then reads the contents of another group of registers (the same or different than those written) in a server device.
2Bh / 0Eh	Encapsulated Interface Transport	Supported subcodes: <ul style="list-style-type: none"> • 0Eh Read Device Identification: Allows reading the identification and other information. Supported ID codes (access type): <ul style="list-style-type: none"> • 00h: Request to get the basic device identification (stream access) • 04h: Request to get one specific identification object (individual access) Supported Object IDs: <ul style="list-style-type: none"> • 00h: Vendor Name (“ABB”) • 01h: Product Code (for example, “AQAKx”) • 02h: Major Minor Revision (combination of contents of parameters 07.05 Firmware version and 58.02 Protocol ID). • 03h: Vendor URL (“www.abb.com”) • 04h: Product name: (“ACQ580”).

Exception codes

The table below shows the Modbus exception codes supported by the embedded fieldbus interface.

Code	Name	Description
01h	ILLEGAL FUNCTION	The function code received in the query is not an allowable action for the server.
02h	ILLEGAL ADDRESS	The data address received in the query is not an allowable address for the server.
03h	ILLEGAL VALUE	The requested quantity of registers is larger than the device can handle. This error does not mean that a value written to the device is outside of the valid range.
04h	DEVICE FAILURE	An unrecoverable error occurred while the server was attempting to perform the requested action. See section Error code registers (holding registers 400090...400100) on page 252.

Coils (0xxxx reference set)

Coils are 1-bit read/write values. Control Word bits are exposed with this data type. The table below summarizes the Modbus coils (0xxxx reference set). Note that the references are 1-based index which match the address transmitted on the wire.

Reference	ABB Drives profile	DCU Profile
000001	OFF1_CONTROL	STOP
000002	OFF2_CONTROL	START
000003	OFF3_CONTROL	Reserved
000004	INHIBIT_OPERATION	Reserved
000005	RAMP_OUT_ZERO	RESET
000006	RAMP_HOLD	EXT2
000007	RAMP_IN_ZERO	RUN_DISABLE
000008	RESET	STOPMODE_RAMP
000009	Not for ACQ580	STOPMODE_EMERGENCY_RAMP
000010	Not for ACQ580	STOPMODE_COAST
000011	REMOTE_CMD	Reserved
000012	EXT_CTRL_LOC	RAMP_OUT_ZERO
000013	USER_0	RAMP_HOLD
000014	USER_1	RAMP_IN_ZERO
000015	USER_2	Reserved
000016	USER_3	Reserved
000017	Reserved	FB_LOCAL_CTL
000018	Reserved	FB_LOCAL_REF
000019	Reserved	Reserved
000020	Reserved	Reserved
000021	Reserved	Reserved
000022	Reserved	Reserved
000023	Reserved	USER_0
000024	Reserved	USER_1
000025	Reserved	USER_2
000026	Reserved	USER_3
000027	Reserved	Reserved
000028	Reserved	Reserved
000029	Reserved	Reserved
000030	Reserved	Reserved
000031	Reserved	Reserved
000032	Reserved	Reserved

Reference	ABB Drives profile	DCU Profile
000033	Control for relay output RO1 (parameter <i>10.99 RO/DIO control word</i> , bit 0)	Control for relay output RO1 (parameter <i>10.99 RO/DIO control word</i> , bit 0)
000034	Control for relay output RO2 (parameter <i>10.99 RO/DIO control word</i> , bit 1)	Control for relay output RO2 (parameter <i>10.99 RO/DIO control word</i> , bit 1)
000035	Control for relay output RO3 (parameter <i>10.99 RO/DIO control word</i> , bit 2)	Control for relay output RO3 (parameter <i>10.99 RO/DIO control word</i> , bit 2)
000036	Control for relay output RO4 (parameter <i>10.99 RO/DIO control word</i> , bit 3)	Control for relay output RO4 (parameter <i>10.99 RO/DIO control word</i> , bit 3)
000037	Control for relay output RO5 (parameter <i>10.99 RO/DIO control word</i> , bit 4)	Control for relay output RO5 (parameter <i>10.99 RO/DIO control word</i> , bit 4)

Discrete inputs (1xxxx reference set)

Discrete inputs are 1-bit read-only values. Status Word bits are exposed with this data type. The table below summarizes the Modbus discrete inputs (1xxxx reference set). Note that the references are 1-based index which match the address transmitted on the wire.

Reference	ABB Drives profile	DCU Profile
100001	RDY_ON	READY
100002	RDY_RUN	D
100003	RDY_REF	Reserved
100004	TRIPPED	RUNNING
100005	OFF_2_STATUS	ZERO_SPEED
100006	OFF_3_STATUS	Reserved
100007	SWC_ON_INHIB	Reserved
100008	ALARM	AT_SETPOINT
100009	AT_SETPOINT	LIMIT
100010	REMOTE	SUPERVISION
100011	ABOVE_LIMIT	Reserved
100012	USER_0	Reserved
100013	USER_1	PANEL_LOCAL
100014	USER_2	FIELDBUS_LOCAL
100015	USER_3	EXT2_ACT
100016	Reserved	FAULT
100017	Reserved	ALARM
100018	Reserved	Reserved
100019	Reserved	Reserved
100020	Reserved	Reserved
100021	Reserved	CTL_MODE
100022	Reserved	Reserved
100023	Reserved	USER_0
100024	Reserved	USER_1
100025	Reserved	USER_2
100026	Reserved	USER_3
100027	Reserved	REQ_CTL
100028	Reserved	Reserved
100029	Reserved	Reserved
100030	Reserved	Reserved
100031	Reserved	Reserved
100032	Reserved	Reserved

Reference	ABB Drives profile	DCU Profile
100033	Delayed status of digital input DI1 (parameter 10.02 DI delayed status , bit 0)	Delayed status of digital input DI1 (parameter 10.02 DI delayed status , bit 0)
100034	Delayed status of digital input DI2 (parameter 10.02 DI delayed status , bit 1)	Delayed status of digital input DI2 (parameter 10.02 DI delayed status , bit 1)
100035	Delayed status of digital input DI3 (parameter 10.02 DI delayed status , bit 2)	Delayed status of digital input DI3 (parameter 10.02 DI delayed status , bit 2)
100036	Delayed status of digital input DI4 (parameter 10.02 DI delayed status , bit 3)	Delayed status of digital input DI4 (parameter 10.02 DI delayed status , bit 3)
100037	Delayed status of digital input DI5 (parameter 10.02 DI delayed status , bit 4)	Delayed status of digital input DI5 (parameter 10.02 DI delayed status , bit 4)
100038	Delayed status of digital input DI6 (parameter 10.02 DI delayed status , bit 5)	Delayed status of digital input DI6 (parameter 10.02 DI delayed status , bit 5)

Error code registers (holding registers 400090...400100)

These registers contain information about the last query. The error register is cleared when a query has finished successfully.

Reference	Name	Description
400090	Reset Error Registers	1 = Reset internal error registers (91...95). 0 = Do nothing.
400091	Error Function Code	Function code of the failed query.
400092	Error Code	Set when exception code 04h is generated (see table above). <ul style="list-style-type: none"> • 00h No error • 02h Low/High limit exceeded • 03h Faulty Index: Unavailable index of an array parameter • 05h Incorrect Data Type: Value does not match the data type of the parameter • 65h General Error: Undefined error when handling query
400093	Failed Register	The last register (discrete input, coil, input register or holding register) that failed to be read or written.
400094	Last Register Written Successfully	The last register (discrete input, coil, input register or holding register) that was written successfully.
400095	Last Register Read Successfully	The last register (discrete input, coil, input register or holding register) that was read successfully.

9

Fieldbus control through a fieldbus adapter

What this chapter contains

This chapter describes how the drive can be controlled by external devices over a communication network (fieldbus) through an optional fieldbus adapter module.

The fieldbus control interface of the drive is described first, followed by a configuration example.

System overview

The drive can be connected to an external control system through an optional fieldbus adapter (“fieldbus adapter A” = FBA A) mounted onto the control unit of the drive. The drive can be configured to receive all of its control information through the fieldbus interface, or the control can be distributed between the fieldbus interface and other available sources such as digital and analog inputs, depending on how control locations EXT1 and EXT2 are configured.

Fieldbus adapters are available for various communication systems and protocols, for example:

- CANopen (FCAN-01 adapter)
 - DeviceNet™ (FDNA-01 adapter)
 - EtherNet/IP™ (FEIP-21 adapter, FENA-21 adapter)
 - Modbus/RTU (FSCA-01 adapter)
 - ModbusTCP (FBMT-21 adapter, FENA-21 adapter)
 - PROFINET IO (FPNO-21 adapter, FENA-21 adapter)
 - PROFIBUS DP (FPBA-01 adapter).
-

Note: The text and examples in this chapter describe the configuration of one fieldbus adapter (FBA) by parameters [50.01](#) ... [50.18](#) and parameter groups [51 FBA A settings](#)...[53 FBA A data out](#).

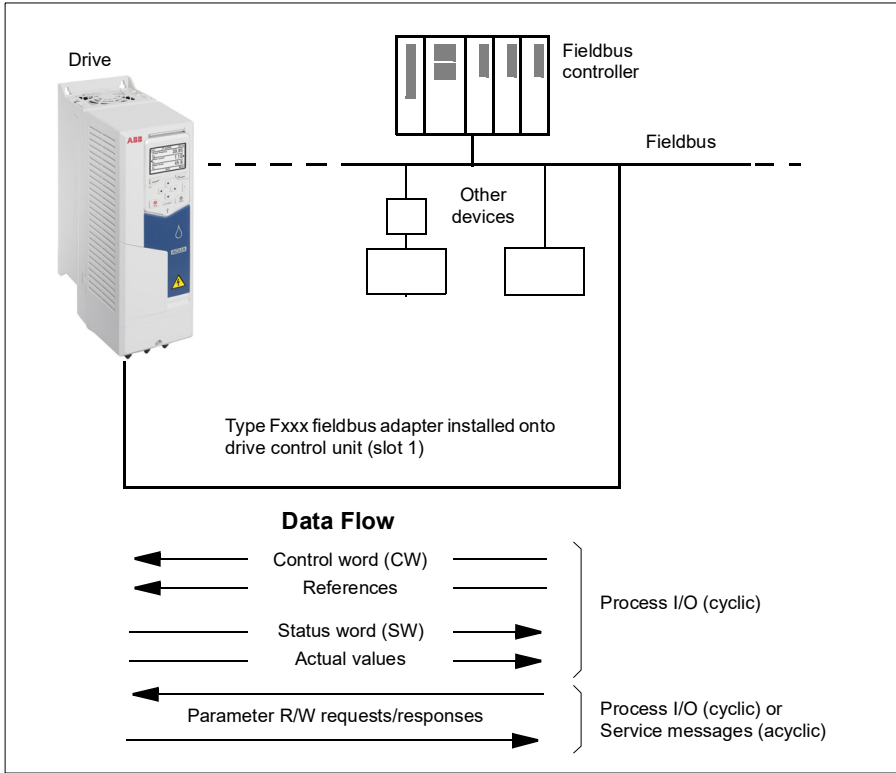

Basics of the fieldbus control interface

The cyclic communication between a fieldbus system and the drive consists of 16- or 32-bit input and output data words. The drive is able to support a maximum of 12 data words (16 bits) in each direction.

Data transmitted from the drive to the fieldbus controller is defined by parameters [52.01 FBA A data in1](#) ... [52.12 FBA A data in12](#). The data transmitted from the fieldbus controller to the drive is defined by parameters [53.01 FBA A data out1](#) ... [53.12 FBA A data out12](#).

■ Control word and Status word

The Control word is the principal means for controlling the drive from a fieldbus system. It is sent by the fieldbus master station to the drive through the adapter module. The drive switches between its states according to the bit-coded instructions in the Control word, and returns status information to the master in the Status word.

For the ABB Drives communication profile, the contents of the Control word and the Status word are detailed on pages [258](#) and [259](#), respectively. The drive states are presented in the state diagram (page [260](#)). For other fieldbus-specific communication profiles, see the *User's manual* of the fieldbus adapter.

Debugging the network words

If parameter [50.12 FBA A debug mode](#) is set to *Fast*, the Control word received from the fieldbus is shown by parameter [50.13 FBA A control word](#), and the Status word transmitted to the fieldbus network by [50.16 FBA A status word](#). This “raw” data is very useful to determine if the fieldbus master is transmitting the correct data before handing control to the fieldbus network.

References

References are 16-bit words containing a sign bit and a 15-bit integer. A negative reference (indicating reversed direction of rotation) is formed by calculating the two's complement from the corresponding positive reference.

ABB drives can receive control information from multiple sources including analog and digital inputs, the drive control panel and a fieldbus adapter module. In order to have the drive controlled through the fieldbus, the module must be defined as the source for control information such as reference. This is done using the source selection parameters in groups [22 Speed reference selection](#) and [28 Frequency reference chain](#).

Debugging the network words

If parameter [50.12 FBA A debug mode](#) is set to *Fast*, the references received from the fieldbus are displayed by [50.14 FBA A reference 1](#) and [50.15 FBA A reference 2](#).

Scaling of references

Note: The scalings described below are for the ABB Drives communication profile. Fieldbus-specific communication profiles may use different scalings. For more information, see the *User's manual* of the fieldbus adapter.

The references are scaled as defined by parameters [46.01...46.04](#); which scaling is in use depends on the setting of [50.04 FBA A ref1 type](#) and [50.05 FBA A ref2 type](#).

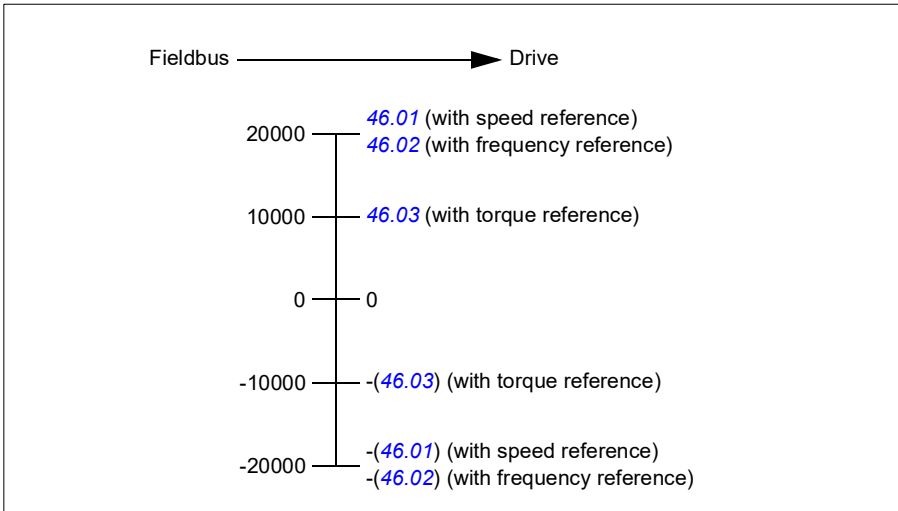

The scaled references are shown by parameters [03.05 FB A reference 1](#) and [03.06 FB A reference 2](#).

Actual values

Note: The scalings described below are for the ABB Drives communication profile. Fieldbus-specific communication profiles may use different scalings. For more information, see the *User's manual* of the fieldbus adapter.

Actual values are 16-bit words containing information on the operation of the drive. The types of the monitored signals are selected by parameters [50.07 FBA A actual 1 type](#) and [50.08 FBA A actual 2 type](#).

Debugging the network words

If parameter [50.12 FBA A debug mode](#) is set to *Fast*, the actual values sent to the fieldbus are displayed by [50.17 FBA A actual value 1](#) and [50.18 FBA A actual value 2](#).

Scaling of actual values

The actual values are scaled as defined by parameters [46.01...46.04](#); which scaling is in use depends on the setting of parameters [50.07 FBA A actual 1 type](#) and [50.08 FBA A actual 2 type](#).

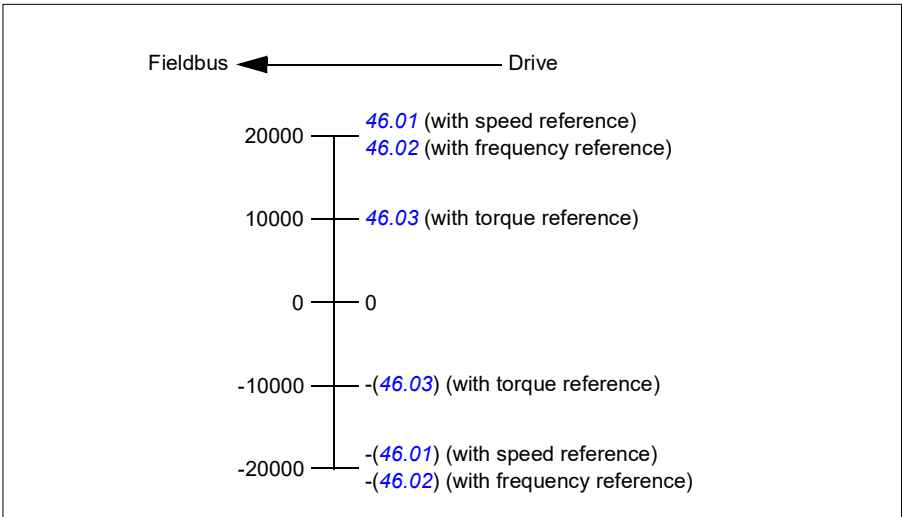

■ Contents of the fieldbus Control word (ABB Drives profile)

The upper case boldface text refers to the states shown in the state diagram (page 260).

Bit	Name	Value	STATE/Description
0	Off1 control	1	Proceed to READY TO OPERATE .
		0	Stop along currently active deceleration ramp. Proceed to OFF1 ACTIVE ; proceed to READY TO SWITCH ON unless other interlocks (OFF2, OFF3) are active.
1	Off2 control	1	Continue operation (OFF2 inactive).
		0	Emergency OFF, coast to a stop. Proceed to OFF2 ACTIVE , proceed to SWITCH-ON INHIBITED .
2	Off3 control	1	Continue operation (OFF3 inactive).
		0	Emergency stop, stop within time defined by drive parameter. Proceed to OFF3 ACTIVE ; proceed to SWITCH-ON INHIBITED .  WARNING: Ensure motor and driven machine can be stopped using this stop mode.
3	Run	1	Proceed to OPERATION ENABLED . Note: Run permissive signal must be active; see the drive documentation. If the drive is set to receive the Run permissive signal from the fieldbus, this bit activates the signal. See also parameter <i>06.18 Start inhibit status word</i> .
		0	Inhibit operation. Proceed to OPERATION INHIBITED .
4	Ramp out zero	1	Normal operation. Proceed to RAMP FUNCTION GENERATOR: OUTPUT ENABLED .
		0	Force Ramp function generator output to zero. The drive will immediately decelerate to zero speed (observing the torque limits).
5	Ramp hold	1	Enable ramp function. Proceed to RAMP FUNCTION GENERATOR: ACCELERATOR ENABLED .
		0	Halt ramping (Ramp Function Generator output held).
6	Ramp in zero	1	Normal operation. Proceed to OPERATING . Note: This bit is effective only if the fieldbus interface is set as the source for this signal by drive parameters.
		0	Force Ramp function generator input to zero.
7	Reset	0=>1	Fault reset if an active fault exists. Proceed to SWITCH-ON INHIBITED . Note: This bit is effective only if the fieldbus interface is set as the source of the reset signal by drive parameters.
		0	Continue normal operation.
8...9	Reserved		
10	Remote cmd	1	Fieldbus control enabled.
		0	Control word and reference not getting through to the drive, except for bits 0...2.
11	Ext ctrl loc	1	Select External Control Location EXT2. Effective if control location is parameterized to be selected from fieldbus.
		0	Select External Control Location EXT1. Effective if control location is parameterized to be selected from fieldbus.
12	User bit 0	1	User configurable
		0	
13	User bit 1	1	
		0	
14	User bit 2	1	
		0	
15	User bit 3	1	
		0	

■ Contents of the fieldbus Status word (ABB Drives profile)

The upper case boldface text refers to the states shown in the state diagram (page 260).

Bit	Name	Value	STATE/Description
0	Ready to switch ON	1	READY TO SWITCH ON.
		0	NOT READY TO SWITCH ON.
1	Ready run	1	READY TO OPERATE.
		0	OFF1 ACTIVE.
2	Ready ref	1	OPERATION ENABLED.
		0	OPERATION INHIBITED. See also parameter 06.18 Start inhibit status word .
3	Tripped	1	FAULT.
		0	No fault.
4	Off 2 inactive	1	OFF2 inactive.
		0	OFF2 ACTIVE.
5	Off 3 inactive	1	OFF3 inactive.
		0	OFF3 ACTIVE.
6	Switch-on inhibited	1	SWITCH-ON INHIBITED.
		0	–
7	Warning	1	Warning active.
		0	No warning active.
8	At setpoint	1	OPERATING. Actual value equals reference = is within tolerance limits (see parameters 46.21...46.22).
		0	Actual value differs from reference = is outside tolerance limits.
9	Remote	1	Drive control location: REMOTE (EXT1 or EXT2).
		0	Drive control location: LOCAL.
10	Above limit	-	See bit 10 of 06.17 Drive status word 2 .
11	User bit 0	-	See parameter 06.30 MSW bit 11 selection .
12	User bit 1	-	See parameter 06.31 MSW bit 12 selection .
13	User bit 2	-	See parameter 06.32 MSW bit 13 selection .
14	User bit 3	-	See parameter 06.33 MSW bit 14 selection .
15	Reserved		

■ The state diagram

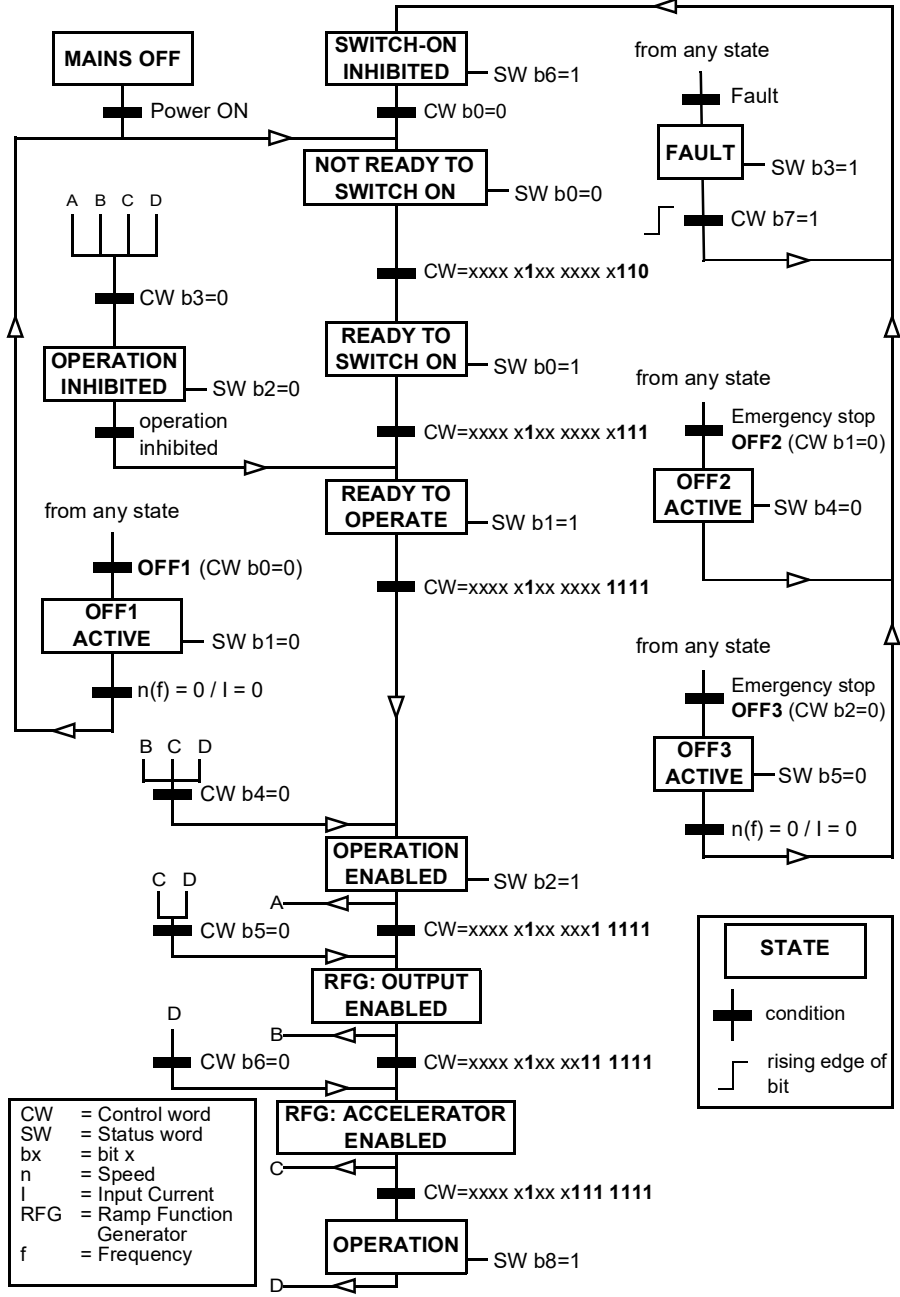

Setting up the drive for fieldbus control

1. Install the fieldbus adapter module mechanically and electrically according to the instructions given in the *User's manual* of the module.
2. Power up the drive.
3. Enable the communication between the drive and the fieldbus adapter module with parameter [50.01 FBA A enable](#).
4. With [50.02 FBA A comm loss func](#), select how the drive should react to a fieldbus communication break.
Note: This function monitors both the communication between the fieldbus master and the adapter module and the communication between the adapter module and the drive.
5. With [50.03 FBA A comm loss t out](#), define the time between communication break detection and the selected action.
6. Select application-specific values for the rest of the parameters in group [50 Fieldbus adapter \(FBA\)](#), starting from [50.04](#). Examples of appropriate values are shown in the tables below.
7. Set the fieldbus adapter module configuration parameters in group [51 FBA A settings](#). As a minimum, set the required node address and the communication profile.
8. Define the process data transferred to and from the drive in parameter groups [52 FBA A data in](#) and [53 FBA A data out](#).
Note: Depending on the communication protocol and profile being used, the Control word and Status word may already be configured to be sent/received by the communication system.
9. Save the valid parameter values to permanent memory by setting parameter [96.07 Parameter save manually](#) to [Save](#).
10. Validate the settings made in parameter groups 51, 52 and 53 by setting parameter [51.27 FBA A par refresh](#) to [Configure](#).
11. Configure control locations EXT1 and EXT2 to allow control and reference signals to come from the fieldbus. Examples of appropriate values are shown in the tables below.

■ Parameter setting example: FPBA (PROFIBUS DP) with ABB Drives profile

This example shows how to configure a basic speed control application that uses the ABB Drives communication profile with PPO Type 2. The start/stop commands and reference are according to the ABB Drives profile, speed control mode.

The reference values sent over the fieldbus have to be scaled within the drive so they have the desired effect. The reference value ± 20000 corresponds to the range of speed set in parameter [46.01 Speed scaling](#) (both forward and reverse directions). For example, if [46.01](#) is set to 480 rpm, then 20000 sent over fieldbus will request 480 rpm.

Direction	PZD1	PZD2	PZD3	PZD4	PZD5	PZD6
Out	Control word	Speed reference	Acc time 1		Dec time 1	
In	Status word	Speed actual value	Motor current		DC voltage	

The table below gives the recommended drive parameter settings.

Drive parameter	Setting for ACQ580 drives	Description
50.01 FBA A enable	1 = [slot number]	Enables/disables communication between the drive and the fieldbus adapter module.
50.04 FBA A ref1 type	4 = <i>Speed</i>	Selects the fieldbus A reference 1 type and scaling.
50.07 FBA A actual 1 type	0 = <i>Speed or frequency</i>	Selects the actual value type and scaling according to the currently active Ref1 mode defined in parameter 50.04 .
51.01 FBA A type	1 = FPBA ¹⁾	Displays the type of the fieldbus adapter module.
51.02 Node address	3 ²⁾	Defines the PROFIBUS node address of the fieldbus adapter module.
51.03 Baud rate	12000 ¹⁾	Displays the current baud rate on the PROFIBUS network in kbit/s.
51.04 MSG type	1 = PPO2 ¹⁾	Displays the telegram type selected by the PLC configuration tool.
51.05 Profile	1 = ABB Drives	Selects the Control word according to the ABB Drives profile (speed control mode).
51.07 RPBA mode	0 = Disabled	Disables the RPBA emulation mode.
52.01 FBA A data in1	4 = SW 16bit ¹⁾	Status word
52.02 FBA data in2	5 = Act1 16bit	Actual value 1
52.03 FBA data in3	01.07 ²⁾	Motor current
52.05 FBA data in5	01.11 ²⁾	DC voltage
53.01 FBA data out1	1 = CW 16bit ¹⁾	Control word

Drive parameter	Setting for ACQ580 drives	Description
53.02 FBA data out2	2 = Ref1 16bit	Reference 1 (speed)
53.03 FBA data out3	23.12 ²⁾	Acceleration time 1
53.05 FBA data out5	23.13 ²⁾	Deceleration time 1
<i>51.27 FBA A par refresh</i>	1 = Configure	Validates the configuration parameter settings.
<i>20.01 Ext1 commands</i>	12 = Fieldbus A	Selects fieldbus adapter A as the source of the start and stop commands for external control location EXT1.
<i>20.02 Ext1 start trigger type</i>	1 = Level	Selects a level-triggered start signal for external control location EXT1.
<i>22.11 Ext1 speed ref1</i>	4 = FB A ref1	Selects fieldbus A reference 1 as the source for speed reference 1.

¹⁾ Read-only or automatically detected/set

²⁾ Example

■ Parameter setting example: FPBA (PROFIBUS DP) with PROFIdrive profile

This example shows how to configure a basic speed control application that uses the PROFIdrive communication profile with PPO Type 2. The start/stop commands and reference are according to the PROFIdrive profile, speed control mode.

The reference values sent over the fieldbus have to be scaled within the drive so they have the desired effect. The reference value ± 16384 (4000h) corresponds to the range of speed set in parameter [46.01 Speed scaling](#) (both forward and reverse directions). For example, if [46.01](#) is set to 480 rpm, then 4000h sent over fieldbus will request 480 rpm.

Direction	PZD1	PZD2	PZD3	PZD4	PZD5	PZD6
Out	Control word	Speed reference	Acc time 1		Dec time 1	
In	Status word	Speed actual value	Motor current		DC voltage	

The table below gives the recommended drive parameter settings.

Drive parameter	Setting for ACQ580 drives	Description
50.01 FBA A enable	1 = [slot number]	Enables/disables communication between the drive and the fieldbus adapter module.
50.04 FBA A ref1 type	4 = <i>Speed</i>	Selects the fieldbus A reference 1 type and scaling.
50.07 FBA A actual 1 type	0 = <i>Speed or frequency</i>	Selects the actual value type and scaling according to the currently active Ref1 mode defined in parameter 50.04 .
51.01 FBA A type	1 = FPBA ¹⁾	Displays the type of the fieldbus adapter module.
51.02 Node address	3 ²⁾	Defines the PROFIBUS node address of the fieldbus adapter module.
51.03 Baud rate	12000 ¹⁾	Displays the current baud rate on the PROFIBUS network in kbit/s.
51.04 MSG type	1 = PPO2 ¹⁾	Displays the telegram type selected by the PLC configuration tool.
51.05 Profile	0 = PROFIdrive	Selects the Control word according to the PROFIdrive profile (speed control mode).
51.07 RPBA mode	0 = Disabled	Disables the RPBA emulation mode.
52.01 FBA A data in1	4 = SW 16bit ¹⁾	Status word
52.02 FBA data in2	5 = Act1 16bit	Actual value 1
52.03 FBA data in3	01.07 ²⁾	Motor current
52.05 FBA data in5	01.11 ²⁾	DC voltage
53.01 FBA data out1	1 = CW 16bit ¹⁾	Control word

Drive parameter	Setting for ACQ580 drives	Description
53.02 FBA data out2	2 = Ref1 16bit	Reference 1 (speed)
53.03 FBA data out3	23.12 ²⁾	Acceleration time 1
53.05 FBA data out5	23.13 ²⁾	Deceleration time 1
<i>51.27 FBA A par refresh</i>	1 = <i>Configure</i>	Validates the configuration parameter settings.
<i>20.01 Ext1 commands</i>	12 = <i>Fieldbus A</i>	Selects fieldbus adapter A as the source of the start and stop commands for external control location EXT1.
<i>20.02 Ext1 start trigger type</i>	1 = <i>Level</i>	Selects a level-triggered start signal for external control location EXT1.
<i>22.11 Ext1 speed ref1</i>	4 = <i>FB A ref1</i>	Selects fieldbus A reference 1 as the source for speed reference 1.

¹⁾ Read-only or automatically detected/set

²⁾ Example

The start and stop sequences for the parameter examples above are given below.

Control word:

Start:

- 1142 (476h) → NOT READY TO SWITCH ON
- If MSW bit 0 = 1 then
 - 1150 (47Eh) → READY TO SWITCH ON (Stopped)
 - 1151 (47Fh) → OPERATION (Running)

Stop:

- 1143 (477h) = Stop according to [21.03 Stop mode](#) (Preferred)
- 1150 (47Eh) = OFF1 ramp stop (Note: uninterruptable ramp stop)
- 1149 (47Dh) = OFF2 emergency coast to stop
- 1147 (47Bh) = OFF3 emergency ramp stop

Fault reset:

- Rising edge of MCW bit 7

Start after STO:

- If [31.22 STO indication run/stop](#) is not Fault/ Fault, check that [06.18 Start inhibit status word](#), bit 7 STO = 0 before giving a start command.

Automatic drive configuration for fieldbus control

The parameters set on module detection are shown in the table below. See also parameters [07.35 Drive configuration](#) and [07.36 Drive configuration 2](#)

Option	50.01 FBA A enable	50.02 FBA A comm loss func	51.02 FBA A Par2	51.04 FBA A Par4	51.05 FBA A Par5	51.06 FBA A Par6
FENA-21	1 (Enable)	0 (No action)	11	0	-	-
FPBA-01	1 (Enable)	0 (No action)	-	-	1	-
FCAN-01	1 (Enable)	0 (No action)	-	-	0	-
FSCA-01	1 (Enable)	0 (No action)	-	-	-	10
FEIP-21	1 (Enable)	0 (No action)	100	0	-	-
FMBT-21	1 (Enable)	0 (No action)	0	0	-	-
FPNO-21	1 (Enable)	0 (No action)	11	0	-	-
FDNA-01	1 (Enable)	0 (No action)	-	-	-	-

Option	51.07 FBA A Par7	51.21 FBA A Par21	51.23 FBA A Par23	51.24 FBA A Par24	52.01 FBA data in1	52.02 FBA data in2
FENA-21	-	-	-	-	4	5
FPBA-01	-	-	-	-	4	5
FCAN-01	-	-	-	-	-	-
FSCA-01	1	-	-	-	-	-
FEIP-21	-	-	128	128	-	-
FMBT-21	-	1	-	-	-	-
FPNO-21	-	-	-	-	4	5
FDNA-01	-	-	-	-	-	-

9

Option	53.01 FBA data out1	53.02 FBA data out2
FENA-21	1	2
FPBA-01	1	2
FCAN-01	-	-
FSCA-01		
FEIP-21	-	-
FMBT-21	-	-
FPNO-21	1	2
FDNA-01	-	-

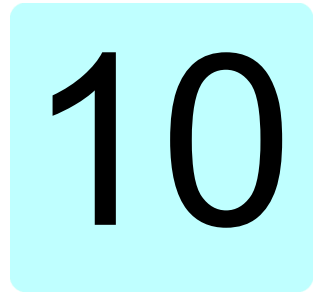

Control chain diagrams

Contents of this chapter

The chapter presents the reference chains of the drive. The control chain diagrams can be used to trace how parameters interact and where parameters have an effect within the drive parameter system.

For a more general diagram, see section [Operating modes of the drive](#) (page 90).

Frequency reference selection

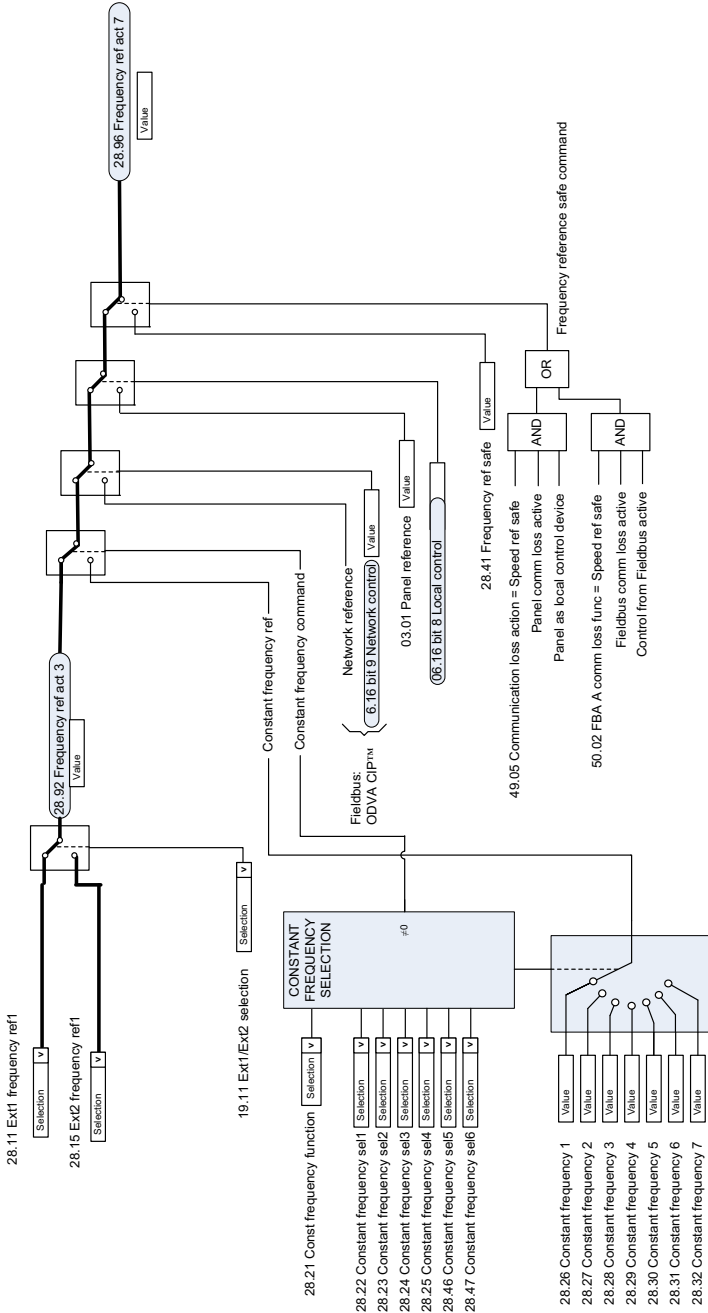

Frequency reference modification

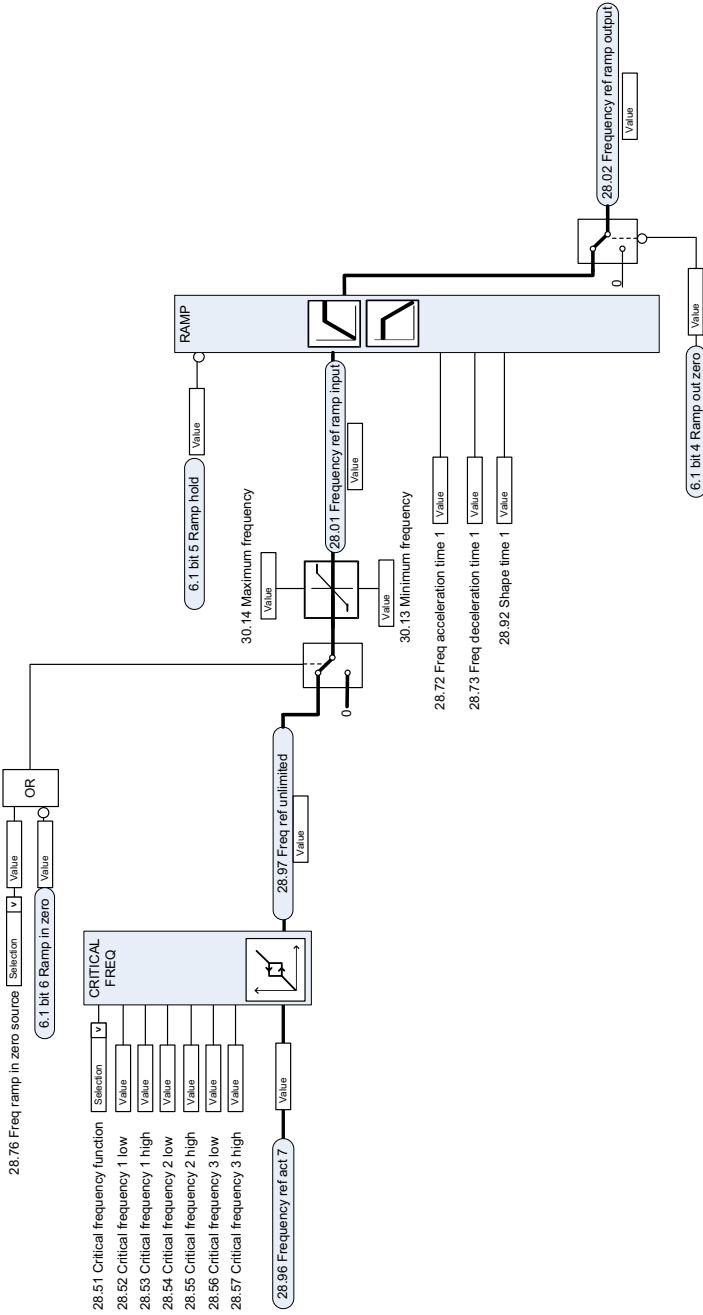

Speed reference source selection II

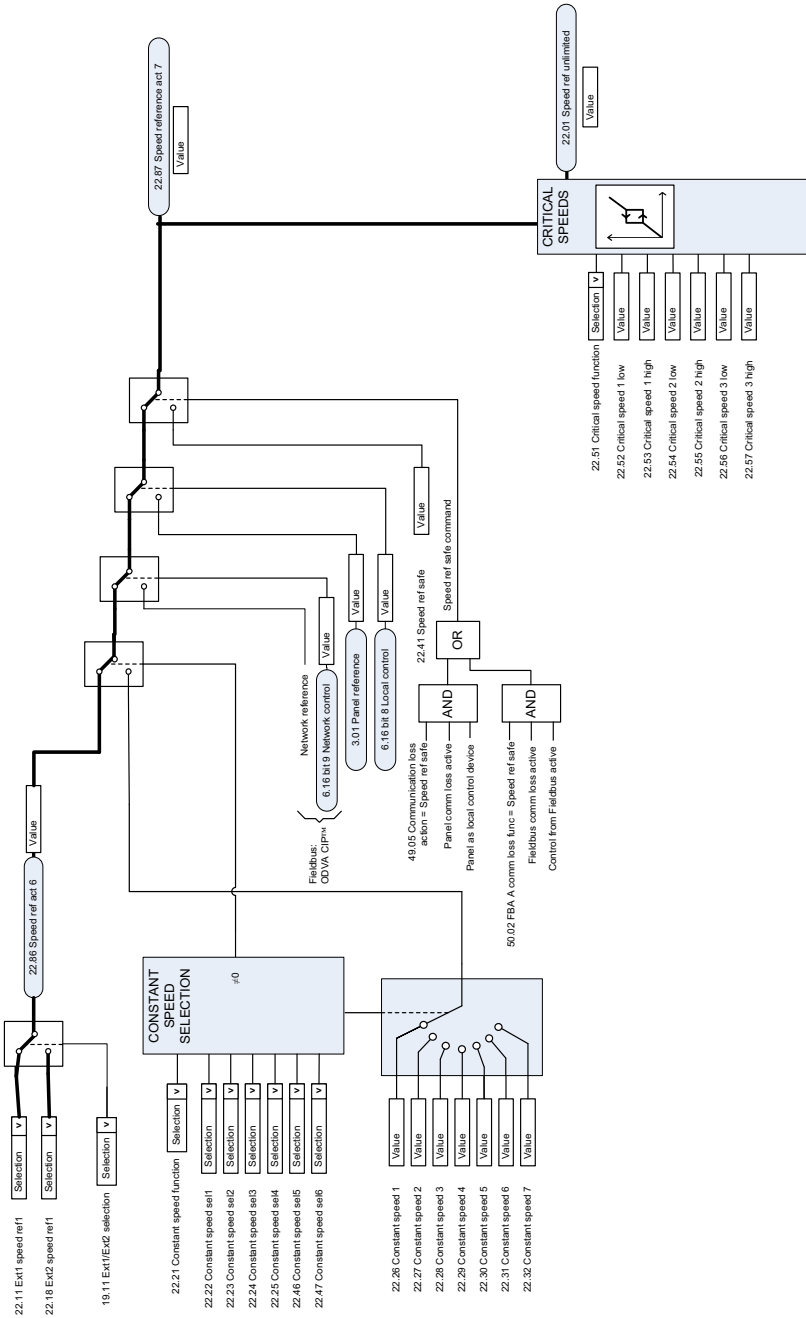

Speed reference ramping and shaping

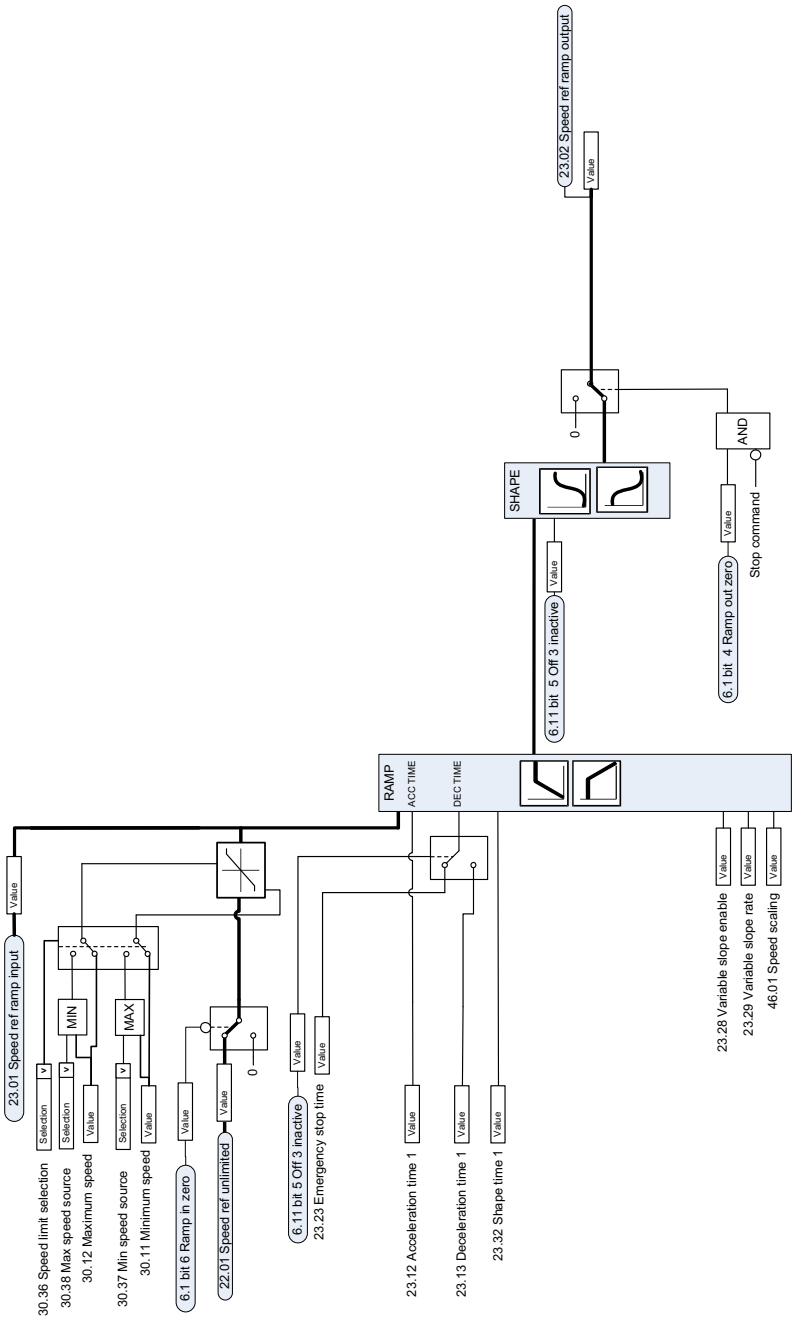

Speed error calculation

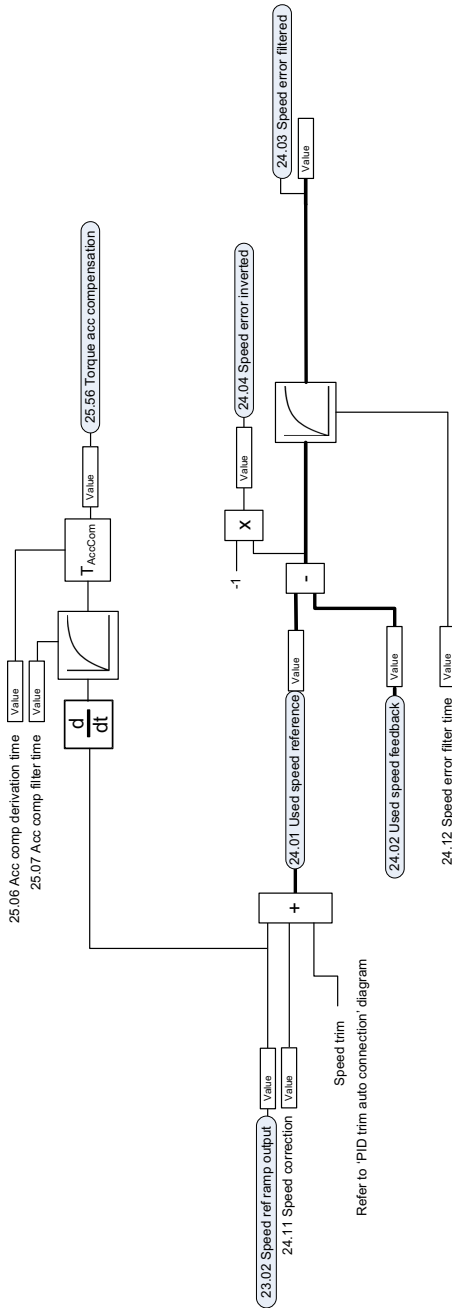

Speed feedback

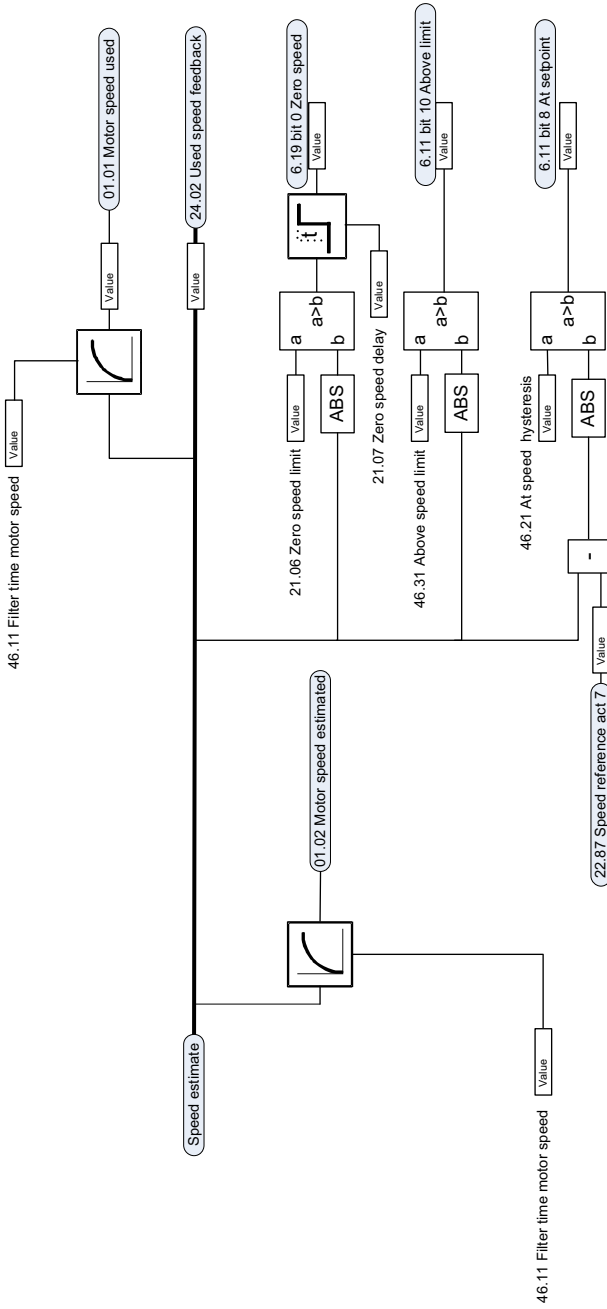

Speed controller

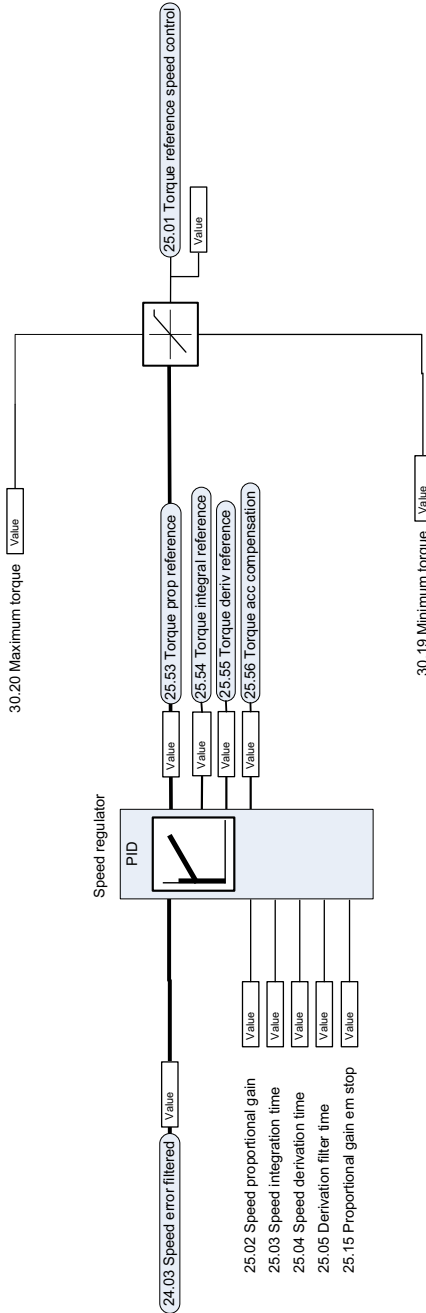

Torque limitation

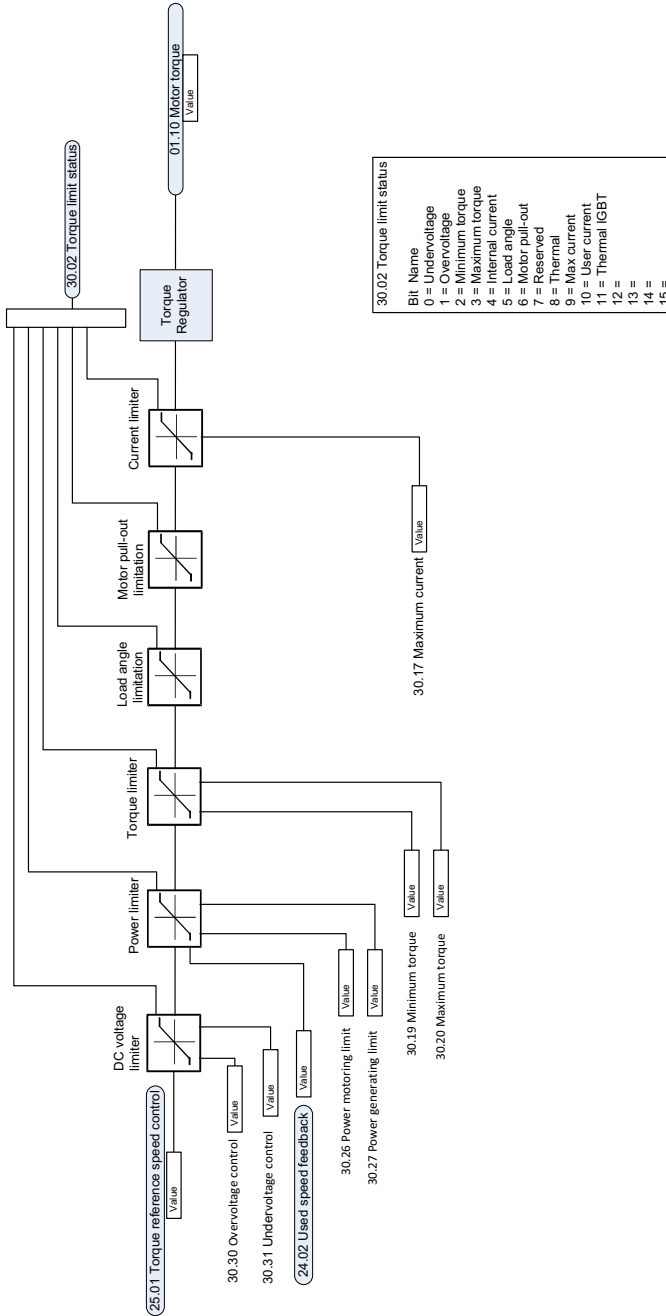

PID flow calculation

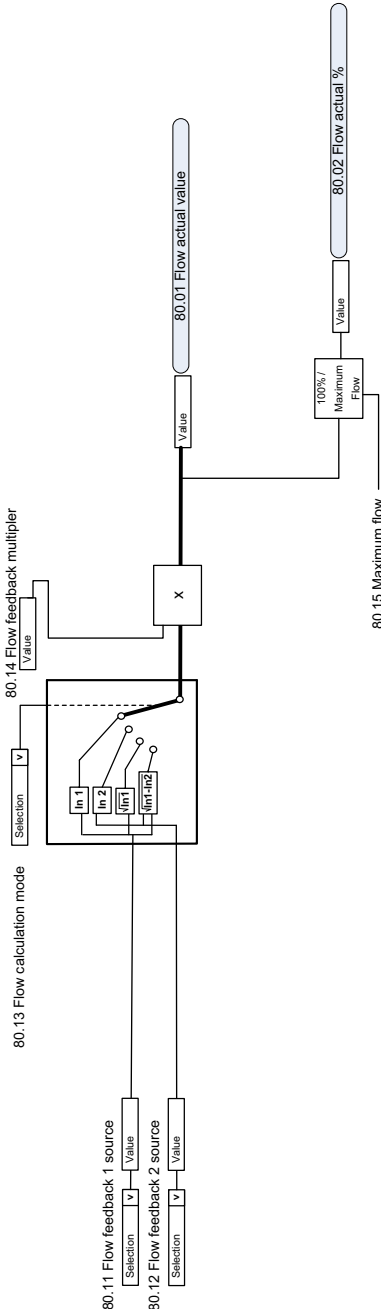

PID setpoint compensation

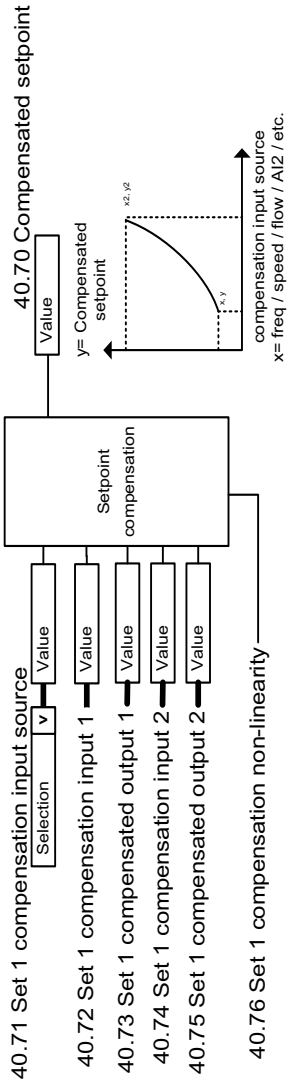

Process PID setpoint and feedback source selection

10

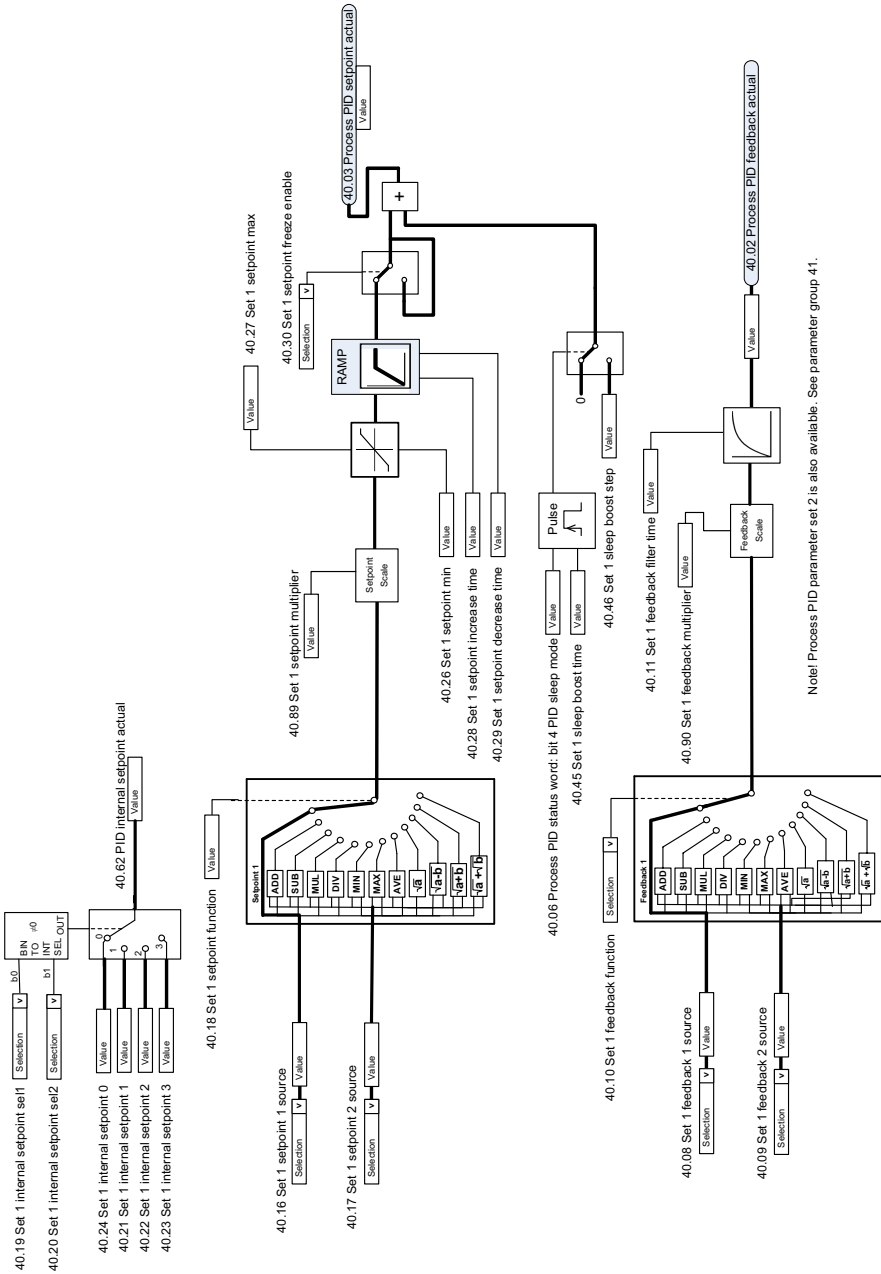

Note! Process PID parameter set 2 is also available. See parameter group 41.

Process PID controller

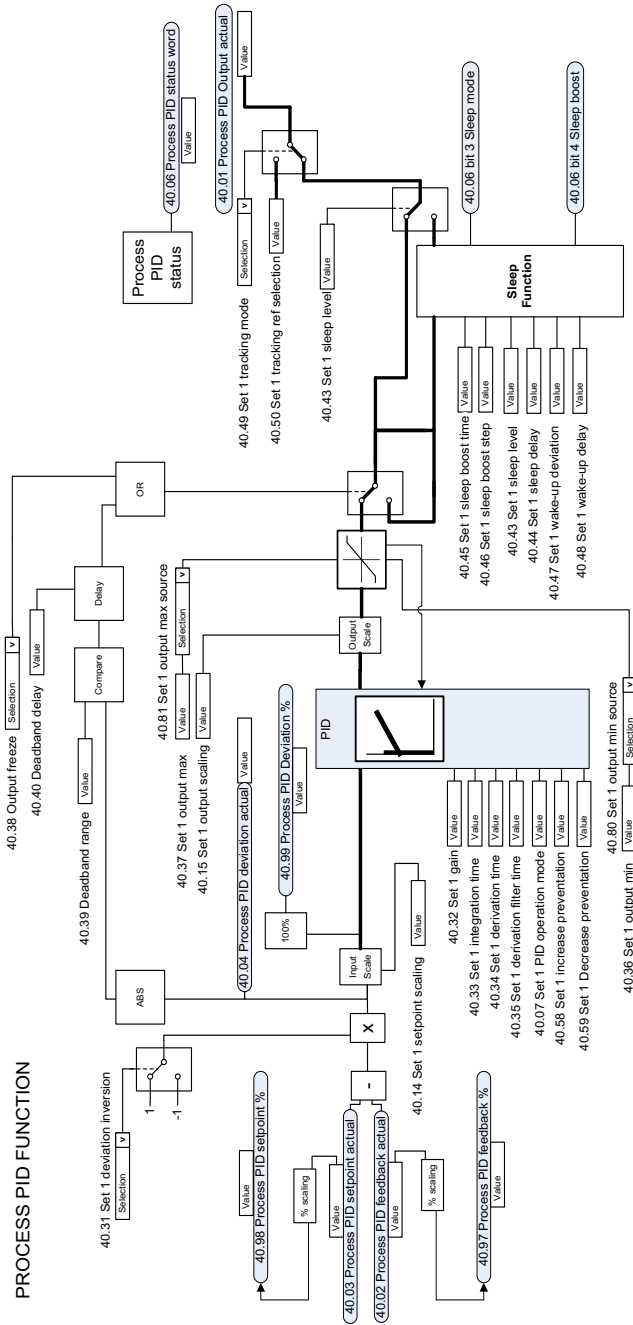

External PID setpoint and feedback source selection

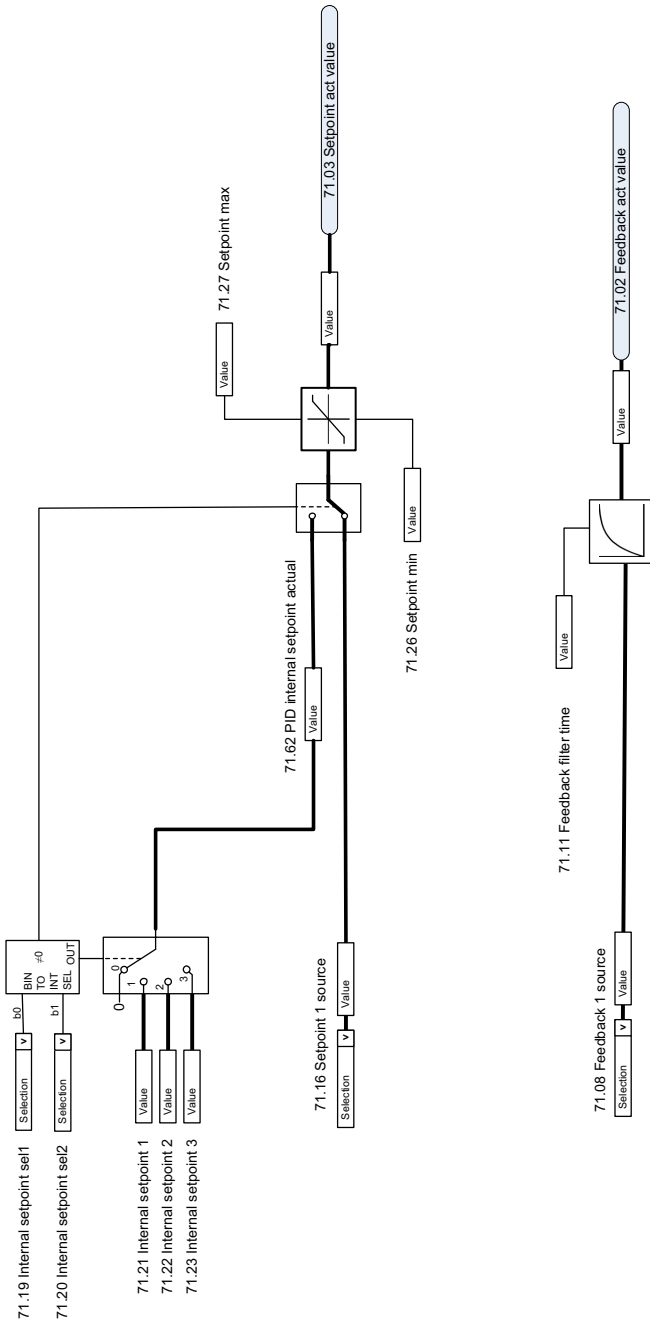

External PID controller

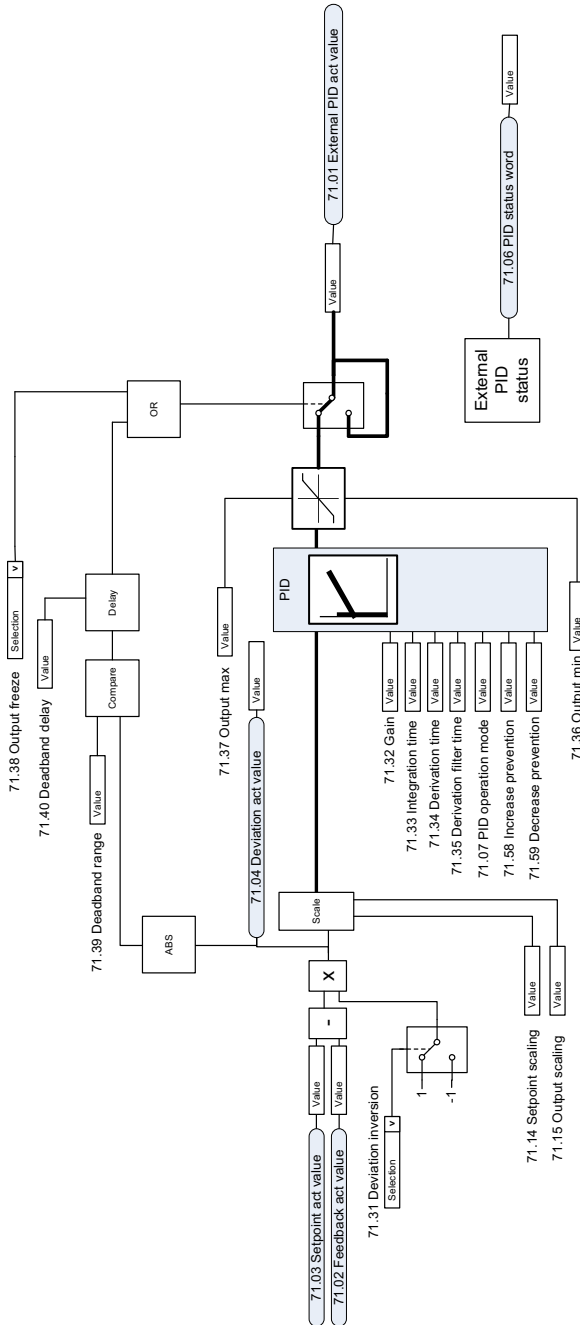

Direction lock

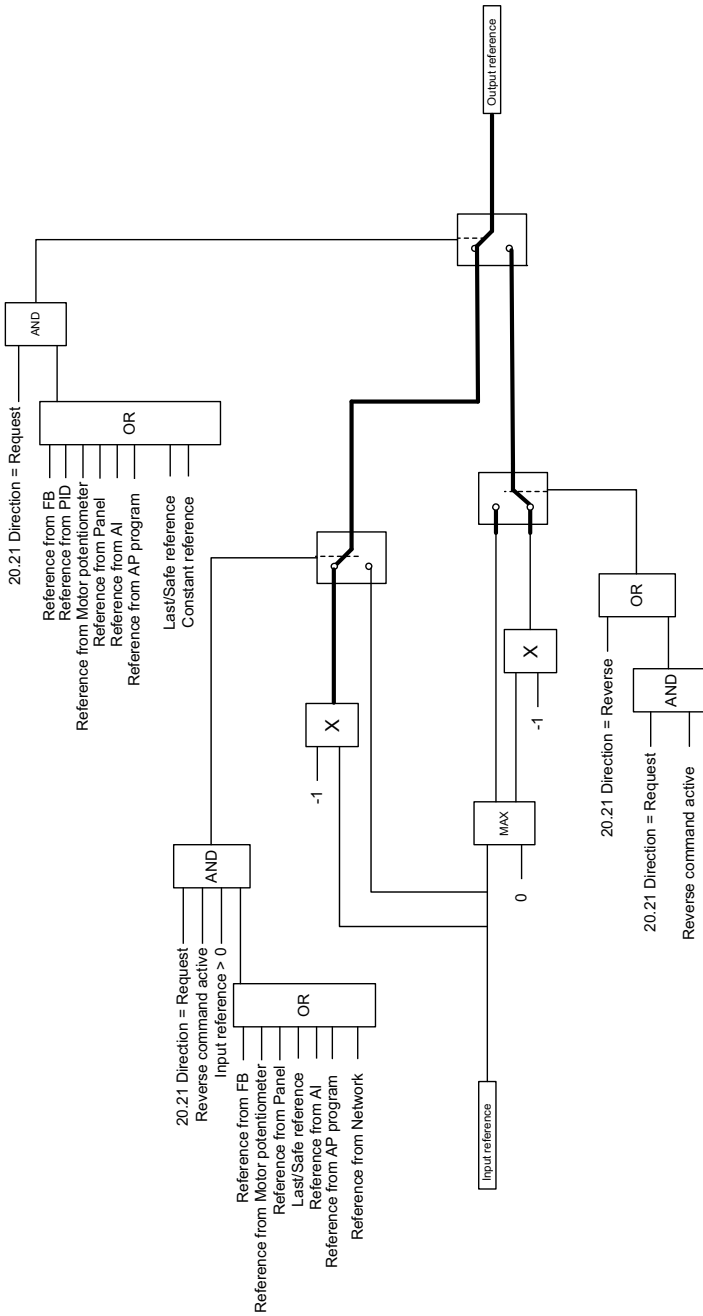



Parameters

What this chapter contains

The chapter describes the parameters, including actual signals, of the control program. At the end of the chapter, on page [540](#), there is a separate list of the parameters whose default values are different between 50 Hz and 60 Hz supply frequency settings.

Terms and abbreviations

Term	Definition
Actual signal	Type of parameter that is the result of a measurement or calculation by the drive, or contains status information. Most actual signals are read-only, but some (especially counter-type actual signals) can be reset.
Def	(In the following table, shown on the same row as the parameter name) The default value of a parameter when used in the default configuration. For information on other macro-specific parameter values, see chapter Default I/O configuration .
FbEq16	(In the following table, shown on the same row as the parameter range, or for each selection) 16-bit fieldbus equivalent: The scaling between the value shown on the control panel and the integer used in communication when a 16-bit value is selected for transmission to an external system. A dash (-) indicates that the parameter is not accessible in 16-bit format. The corresponding 32-bit scalings are listed in chapter Additional parameter data (page 545). Note: Any scaled value that exceeds 32767 will be clamped at 32767 when reading with a 16 bit system.
Other	The value is taken from another parameter. Choosing "Other" displays a parameter list in which the user can specify the source parameter.
Other [bit]	The value is taken from a specific bit in another parameter. Choosing "Other" displays a parameter list in which the user can specify the source parameter and bit.
Parameter	Either a user-adjustable operating instruction for the drive, or an actual signal .
p.u.	Per unit
[parameter number]	Value of the parameter

Summary of parameter groups

Group	Contents	Page
01 Actual values	Basic signals for monitoring the drive.	288
03 Input references	Values of references received from various sources.	292
04 Warnings and faults	Information on warnings and faults that occurred last.	293
05 Diagnostics	Various run-time-type counters and measurements related to drive maintenance.	295
06 Control and status words	Drive control and status words.	298
07 System info	Drive hardware and firmware information.	307
10 Standard DI, RO	Configuration of digital inputs and relay outputs.	309
11 Standard DIO, FI, FO	Configuration of the frequency input.	319
12 Standard AI	Configuration of standard analog inputs.	320
13 Standard AO	Configuration of standard analog outputs.	325
15 I/O extension module	Configuration of the I/O extension module installed in slot 2.	331
19 Operation mode	Selection of local and external control location sources and operating modes.	341
20 Start/stop/direction	Start/stop/direction and run/start enable signal source selection; positive/negative reference enable signal source selection.	342
21 Start/stop mode	Start and stop modes; emergency stop mode and signal source selection; DC magnetization settings.	353
22 Speed reference selection	Speed reference selection; Motor potentiometer settings.	362
23 Speed reference ramp	Speed reference ramp settings (programming of the acceleration and deceleration rates for the drive).	370
24 Speed reference conditioning	Speed error calculation; speed error window control configuration; speed error step.	371
25 Speed control	Speed controller settings.	372
28 Frequency reference chain	Settings for the frequency reference chain.	377
30 Limits	Drive operation limits.	384
31 Fault functions	Configuration of external events; selection of behavior of the drive upon fault situations.	392
32 Supervision	Configuration of signal supervision functions 1..6.	403
34 Timed functions	Configuration of the timed functions.	410
35 Motor thermal protection	Motor thermal protection settings such as temperature measurement configuration, load curve definition and motor fan control configuration; motor overload protection.	418
36 Load analyzer	Peak value and amplitude logger settings.	430
37 User load curve	Settings for user load curve.	433
40 Process PID set 1	Parameter values for process PID control.	437
41 Process PID set 2	A second set of parameter values for process PID control.	453
43 Brake chopper	Settings for the internal brake chopper.	456
45 Energy efficiency	Settings for the energy saving calculators as well as peak and energy loggers.	457
46 Monitoring/scaling settings	Speed supervision settings; actual signal filtering; general scaling settings.	462
47 Data storage	Data storage parameters that can be written to and read from using other parameters' source and target settings.	465

Group	Contents	Page
49 Panel port communication	Communication settings for the control panel port on the drive.	466
50 Fieldbus adapter (FBA)	Fieldbus communication configuration.	467
51 FBA A settings	Fieldbus adapter A configuration.	471
52 FBA A data in	Selection of data to be transferred from drive to fieldbus controller through fieldbus adapter A.	473
53 FBA A data out	Selection of data to be transferred from fieldbus controller to drive through fieldbus adapter A.	473
58 Embedded fieldbus	Configuration of the embedded fieldbus (EFB) interface.	474
60 DDCS communication	DCS communication configuration.	481
61 D2D and DDCS transmit data	Defines the data sent to the DDCS link.	481
62 D2D and DDCS receive data	Defines the data sent to the DDCS link.	482
71 External PID1	Configuration of external PID.	482
76 Multipump configuration	PFC (Pump and fan control), multipump and autochange configuration parameters.	484
77 Multipump maintenance and monitoring	PFC (Pump and fan control) and multipump maintenance and monitoring parameters.	497
80 Flow calculation	Actual flow calculation.	499
81 Sensor settings	Sensor settings for inlet and outlet pressure protection function.	503
82 Pump protections	Settings for quick ramp functions as well as pump protection functions soft pipe fill and dry pump protection.	505
83 Pump cleaning	Settings for the pump cleaning sequence.	509
94 LSU control	Control of the supply unit of the drive, such as DC voltage and reactive power reference.	511
95 HW configuration	Various hardware-related settings.	513
96 System	Language selection; access levels; macro selection; parameter save and restore; control unit reboot; user parameter sets; unit selection; parameter checksum calculation; user lock.	516
97 Motor control	Switching frequency; slip gain; voltage reserve; flux braking; anti-cogging (signal injection); IR compensation.	527
98 User motor parameters	Motor values supplied by the user that are used in the motor model.	532
99 Motor data	Motor configuration settings.	533

Parameter listing

No.	Name/Value	Description	Def/FbEq16
01 Actual values		Basic signals for monitoring the drive. All parameters in this group are read-only unless otherwise noted. Note: Values of these actual signals are filtered with the filter time defined in group 46 Monitoring/scaling settings . The selection lists for parameters in other groups mean the raw value of the actual signal instead. For example, if a selection is "Output frequency" it does not point to the value of parameter 01.06 Output frequency but to the raw value.	
01.01	Motor speed used	Estimated motor speed. A filter time constant for this signal can be defined by parameter 46.11 Filter time motor speed .	-
	-30000.00... 30000.00 rpm	Estimated motor speed.	See par. 46.01
01.02	Motor speed estimated	Estimated motor speed in rpm. A filter time constant for this signal can be defined by parameter 46.11 Filter time motor speed .	-
	-30000.00... 30000.00 rpm	Estimated motor speed.	See par. 46.01
01.03	Motor speed %	Motor speed in percent of the synchronous motor speed.	-
	-1000.00... 1000.00%	Motor speed.	10 = 1%
01.06	Output frequency	Estimated drive output frequency in Hz. A filter time constant for this signal can be defined by parameter 46.12 Filter time output frequency .	-
	-500.00...500.00 Hz	Estimated output frequency.	See par. 46.02
01.07	Motor current	Measured (absolute) motor current in A.	-
	0.00...30000.00 A	Motor current.	See par. 46.05
01.08	Motor current % of motor nom	Motor current (drive output current) in percent of the nominal motor current.	-
	0.0...1000.0%	Motor current.	1 = 1%
01.09	Motor current % of drive nom	Motor current (drive output current) in percent of the nominal drive current.	-
	0.0...1000.0%	Motor current.	1 = 1%
01.10	Motor torque	Motor torque in percent of the nominal motor torque. See also parameter 01.30 Nominal torque scale . A filter time constant for this signal can be defined by parameter 46.13 Filter time motor torque .	-
	-1600.0...1600.0%	Motor torque.	See par. 46.03
01.11	DC voltage	Measured DC link voltage.	-
	0.00...2000.00 V	DC link voltage.	10 = 1 V
01.13	Output voltage	Calculated motor voltage in V AC.	-
	0...2000 V	Motor voltage.	1 = 1 V

No.	Name/Value	Description	Def/FbEq16
01.14	<i>Output power</i>	Drive output power. The unit is selected by parameter 96.16 Unit selection . A filter time constant for this signal can be defined by parameter 46.14 Filter time power .	-
	-32768.00... 32767.00 kW	Output power.	See par. 46.04
01.15	<i>Output power % of motor nom</i>	Output power in percent of the nominal motor power.	-
	-300.00... 300.00%	Output power.	10 = 1%
01.17	<i>Motor shaft power</i>	Estimated mechanical power at motor shaft.	-
	-32768.00... 32767.00 kW or hp	Motor shaft power.	1 = 1 unit
01.18	<i>Inverter GWh counter</i>	Amount of energy that has passed through the drive (in either direction) in full gigawatt-hours. The minimum value is zero.	-
	0...65535 GWh	Energy in GWh.	1 = 1 GWh
01.19	<i>Inverter MWh counter</i>	Amount of energy that has passed through the drive (in either direction) in full megawatt-hours. Whenever the counter rolls over, 01.18 Inverter GWh counter is incremented. The minimum value is zero.	-
	0...1000 MWh	Energy in MWh.	1 = 1 MWh
01.20	<i>Inverter kWh counter</i>	Amount of energy that has passed through the drive (in either direction) in full kilowatt-hours. Whenever the counter rolls over, 01.19 Inverter MWh counter is incremented. The minimum value is zero.	-
	0...1000 kWh	Energy in kWh.	10 = 1 kWh
01.24	<i>Flux actual %</i>	Used flux reference in percent of nominal flux of motor.	-
	0...200%	Flux reference.	1 = 1%
01.30	<i>Nominal torque scale</i>	Torque that corresponds to 100% of nominal motor torque. The unit is selected by parameter 96.16 Unit selection . Note: This value is copied from parameter 99.12 Motor nominal torque if entered. Otherwise the value is calculated from other motor data.	-
	0.000...4000000 N·m or lb·ft	Nominal torque.	1 = 100 unit
01.31	<i>Ambient temperature</i>	Ambient temperature of the drive. Only for drive frames R6 or larger.	-
	40.0...120.0 °C or °F	Temperature.	1 = 1 unit
01.50	<i>Current hour kWh</i>	Current hour energy consumption. This is the energy of the last 60 minutes (not necessarily continuous) the drive has been running, not the energy of a calendar hour. If the power is cycled, after the drive is again up and running, the parameter value is set to the value it had before the power cycle.	-
	0.00...1000000.00 kWh	Energy.	-

No.	Name/Value	Description	Def/FbEq16
01.51	<i>Previous hour kWh</i>	Previous hour energy consumption. The value <i>01.50 Current hour kWh</i> is stored here when its values has been cumulated for 60 minutes. If the power is cycled, after the drive is again up and running, the parameter value is set to the value it had before the power cycle.	-
	0.00...1000000.00 kWh	Energy.	-
01.52	<i>Current day kWh</i>	Current day energy consumption. This is the energy of the last 24 hours (not necessarily continuous) the drive has been running, not the energy of a calendar day. If the power is cycled, after the drive is again up and running, the parameter value is set to the value it had before the power cycle.	-
	0.00... 1000000.00 kWh	Energy.	-
01.53	<i>Previous day kWh</i>	Previous day energy consumption. The value <i>01.52 Current day kWh</i> is stored here when its value has been cumulated for 24 hours. If the power is cycled, after the drive is again up and running, the parameter value is set to the value it had before the power cycle.	-
	0.00... 1000000.00 kWh	Energy.	-
01.54	<i>Cumulative inverter energy</i>	Amount of energy that has passed through the drive (in either direction) in full kilowatt-hours. The minimum value is zero.	-
	-200000000.0... 200000000.0 kWh	Energy in kWh.	10 = 1 kWh
01.55	<i>Inverter GWh counter (resettable)</i>	Amount of energy that has passed through the drive (in either direction) in full gigawatt-hours. The minimum value is zero. You can reset the value by setting it to zero or by pressing the Reset softkey for 3 seconds. Resetting any of parameters <i>01.55...01.58</i> resets all of them.	-
	0...65535 GWh	Energy in GWh.	1 = 1 GWh
01.56	<i>Inverter MWh counter (resettable)</i>	Amount of energy that has passed through the drive (in either direction) in full megawatt-hours. Whenever the counter rolls over, <i>01.55 Inverter GWh counter (resettable)</i> is incremented. The minimum value is zero. You can reset the value by setting it to zero or by pressing the Reset softkey for 3 seconds. Resetting any of parameters <i>01.55...01.58</i> resets all of them.	-
	0...1000 MWh	Energy in MWh.	1 = 1 MWh
01.57	<i>Inverter kWh counter (resettable)</i>	Amount of energy that has passed through the drive (in either direction) in full kilowatt-hours. Whenever the counter rolls over, <i>01.56 Inverter MWh counter (resettable)</i> is incremented. The minimum value is zero. You can reset the value by setting it to zero or by pressing the Reset softkey for 3 seconds. Resetting any of parameters <i>01.55...01.58</i> resets all of them.	-
	0...1000 kWh	Energy in kWh.	10 = 1 kWh

No.	Name/Value	Description	Def/FbEq16
01.58	<i>Cumulative inverter energy (resettable)</i>	Amount of energy that has passed through the drive (in either direction) in full kilowatt-hours. The minimum value is zero. You can reset the value by setting it to zero or by pressing the Reset softkey for 3 seconds. Resetting any of parameters 01.55...01.58 resets all of them.	-
	-200000000.0... 200000000.0 kWh	Energy in kWh.	10 = 1 kWh
01.61	<i>Abs motor speed used</i>	Absolute value of parameter 01.01 <i>Motor speed used</i> .	-
	0.00... 30000.00 rpm	Estimated motor speed.	See par. 46.01
01.62	<i>Abs motor speed %</i>	Absolute value of parameter 01.03 <i>Motor speed %</i> .	-
	0.00... 1000.00%	Estimated motor speed.	10 = 1%
01.63	<i>Abs output frequency</i>	Absolute value of parameter 01.06 <i>Output frequency</i> .	-
	0.00...500.00 Hz	Estimated output frequency.	See par. 46.02
01.64	<i>Abs motor torque</i>	Absolute value of parameter 01.10 <i>Motor torque</i> .	-
	0.0...1600.0%	Motor torque.	See par. 46.03
01.65	<i>Abs output power</i>	Absolute value of parameter 01.14 <i>Output power</i> .	-
	0.00... 32767.00 kW	Output power.	1 = 1 kW
01.66	<i>Abs output power % motor nom</i>	Absolute value of parameter 01.15 <i>Output power % of motor nom</i> .	-
	0.00... 300.00%	Output power.	10 = 1%
01.67	<i>Abs output power % drive nom</i>	Absolute value of output power % of drive nominal.	-
	0.00... 300.00%	Output power.	10 = 1%
01.68	<i>Abs motor shaft power</i>	Absolute value of parameter 01.17 <i>Motor shaft power</i> .	-
	0.00... 32767.00 kW or hp	Motor shaft power.	1 = 1 unit
01.102	<i>Line current</i>	(Only visible for ACQ580-31 and ACQ580-34). Estimated line current flowing through the supply unit.	-
	0.00 ... 30000.00 A	Estimated line current.	See par. 46.05
01.104	<i>Active current</i>	(Only visible for ACQ580-31 and ACQ580-34). Estimated active current flowing through the supply unit.	-
	-30000.00 ... 30000.00 A	Estimated active current.	See par. 46.05
01.106	<i>Reactive current</i>	(Only visible for ACQ580-31 and ACQ580-34). Estimated reactive current flowing through the supply unit.	-
	-30000.00 ... 30000.00 A	Estimated reactive current.	See par. 46.05

No.	Name/Value	Description	Def/FbEq16
01.108	<i>Grid frequency</i>	(Only visible for ACQ580-31 and ACQ580-34). Estimated frequency of the power supply network.	-
	0.00 ... 100.00 Hz	Estimated supply frequency.	See par. 46.02
01.109	<i>Grid voltage</i>	(Only visible for ACQ580-31 and ACQ580-34). Estimated voltage of the power supply network.	-
	0.00 ... 2000.00 V	Estimated supply voltage.	10 = 1 V
01.110	<i>Grid apparent power</i>	(Only visible for ACQ580-31 and ACQ580-34). Estimated apparent power being transferred through the supply unit.	-
	-30000.00 ... 30000.00 kVA	Estimated apparent power.	See par. 46.04
01.112	<i>Grid power</i>	(Only visible for ACQ580-31 and ACQ580-34). Estimated power being transferred through the supply unit.	-
	-30000.00 ... 30000.00 kW	Estimated supply power.	See par. 46.04
01.114	<i>Grid reactive power</i>	(Only visible for ACQ580-31 and ACQ580-34). Estimated reactive power being transferred through the supply unit.	-
	-30000.00 ... 30000.00 kvar	Estimated reactive power.	10 = 1 kvar
01.116	<i>LSU cos Phi</i>	(Only visible for ACQ580-31 and ACQ580-34). Power factor of the supply unit.	-
	-1.00 ... 1.00	Power factor.	100 = 1
01.164	<i>LSU nominal power</i>	(Only visible for ACQ580-31 and ACQ580-34). Nominal power of the supply unit.	-
	0...30000 kW	Nominal power.	1 = 1 kW
03 Input references		Values of references received from various sources. All parameters in this group are read-only unless otherwise noted.	
03.01	<i>Panel reference</i>	Reference 1 given from the control panel or PC tool.	-
	-100000.00... 100000.00	Control panel or PC tool reference.	1 = 10
03.02	<i>Panel reference remote</i>	Reference 2 given from the control panel or PC tool.	-
	-100000.00... 100000.00	Control panel or PC tool reference.	1 = 10
03.05	<i>FB A reference 1</i>	Reference 1 received through fieldbus adapter A. See also chapter Fieldbus control through a fieldbus adapter .	-
	-100000.00... 100000.00	Reference 1 from fieldbus adapter A.	1 = 10
03.06	<i>FB A reference 2</i>	Reference 2 received through fieldbus adapter A.	-
	-100000.00... 100000.00	Reference 2 from fieldbus adapter A.	1 = 10

No.	Name/Value	Description	Def/FbEq16
03.09	EFB reference 1	Scaled reference 1 received through the embedded fieldbus interface.	-
	-30000.00... 30000.00	Scaled reference 1 received through the embedded fieldbus interface.	1 = 10
03.10	EFB reference 2	Scaled reference 2 received through the embedded fieldbus interface.	-
	-30000.00... 30000.00	Scaled reference 2 received through the embedded fieldbus interface.	1 = 10

04 Warnings and faults		Information on warnings and faults that occurred last. For explanations of individual warning and fault codes, see chapter Fault tracing . All parameters in this group are read-only unless otherwise noted. Fault and event logs can be cleared with parameter 96.51 Clear fault and event logger .	
04.01	Tripping fault	Code of the 1st active fault (the fault that caused the current trip).	-
	0000h...FFFFh	1st active fault.	1 = 1
04.02	Active fault 2	Code of the 2nd active fault.	-
	0000h...FFFFh	2nd active fault.	1 = 1
04.03	Active fault 3	Code of the 3rd active fault.	-
	0000h...FFFFh	3rd active fault.	1 = 1
04.06	Active warning 1	Code of the 1st active warning.	-
	0000h...FFFFh	1st active warning.	1 = 1
04.07	Active warning 2	Code of the 2nd active warning.	-
	0000h...FFFFh	2nd active warning.	1 = 1
04.08	Active warning 3	Code of the 3rd active warning.	-
	0000h...FFFFh	3rd active warning.	1 = 1
04.11	Latest fault	Code of the 1st stored (non-active) fault.	-
	0000h...FFFFh	1st stored fault.	1 = 1
04.12	2nd latest fault	Code of the 2nd stored (non-active) fault.	-
	0000h...FFFFh	2nd stored fault.	1 = 1
04.13	3rd latest fault	Code of the 3rd stored (non-active) fault.	-
	0000h...FFFFh	3rd stored fault.	1 = 1
04.16	Latest warning	Code of the 1st stored (non-active) warning.	-
	0000h...FFFFh	1st stored warning.	1 = 1
04.17	2nd latest warning	Code of the 2nd stored (non-active) warning.	-
	0000h...FFFFh	2nd stored warning.	1 = 1
04.18	3rd latest warning	Code of the 3rd stored (non-active) warning.	-
	0000h...FFFFh	3rd stored warning.	1 = 1

No.	Name/Value	Description	Def/FbEq16															
04.40	<i>Event word 1</i>	User-defined event word. This word collects the status of the events (warnings, faults or pure events) selected by parameters <i>04.41...04.71</i> . This parameter is read-only.	-															
<table border="1"> <thead> <tr> <th>Bit</th> <th>Name</th> <th>Description</th> </tr> </thead> <tbody> <tr> <td>0</td> <td>User bit 0</td> <td>1 = Event selected by parameter <i>04.41</i> is active</td> </tr> <tr> <td>1</td> <td>User bit 1</td> <td>1 = Event selected by parameter <i>04.43</i> is active</td> </tr> <tr> <td>...</td> <td>...</td> <td>...</td> </tr> <tr> <td>15</td> <td>User bit 15</td> <td>1 = Event selected by parameter <i>04.71</i> is active</td> </tr> </tbody> </table>				Bit	Name	Description	0	User bit 0	1 = Event selected by parameter <i>04.41</i> is active	1	User bit 1	1 = Event selected by parameter <i>04.43</i> is active	15	User bit 15	1 = Event selected by parameter <i>04.71</i> is active
Bit	Name	Description																
0	User bit 0	1 = Event selected by parameter <i>04.41</i> is active																
1	User bit 1	1 = Event selected by parameter <i>04.43</i> is active																
...																
15	User bit 15	1 = Event selected by parameter <i>04.71</i> is active																
	0000h...FFFFh	User-defined event word.	1 = 1															
04.41	<i>Event word 1 bit 0 code</i>	Selects the hexadecimal code of an event (warning, fault or pure event) whose status is shown as bit 0 of <i>04.40 Event word 1</i> . The event codes are listed in chapter <i>Fault tracing</i> (page 187).	2310h															
	0000h...FFFFh	Default fault 2310 Overcurrent.	1 = 1															
04.43	<i>Event word 1 bit 1 code</i>	Selects the hexadecimal code of an event (warning, fault or pure event) whose status is shown as bit 1 of <i>04.40 Event word 1</i> . The events are listed in chapter <i>Fault tracing</i> (page 187).	3210h															
	0000h...FFFFh	Default fault 3210 DC link overvoltage.	1 = 1															
04.45	Event word 1 bit 2 code	Default fault 4310 Excess temperature.	4310h															
04.47	Event word 1 bit 3 code	Default fault 2340 Short circuit.	2340h															
04.49	Event word 1 bit 4 code	No default fault	0000h															
04.51	Event word 1 bit 5 code	Default fault 3220 DC link undervoltage.	3220h															
04.53	Event word 1 bit 6 code	Default fault 80A0 AI supervision.	80A0h															
04.55	Event word 1 bit 7 code	No default fault.	0000h															
04.57	Event word 1 bit 8 code	Default fault 7122 Motor overload.	7122h															
04.59	Event word 1 bit 9 code	Default fault 7081 Control panel loss.	7081h															
04.61	Event word 1 bit 10 code	Default fault FF61 ID run.	FF61h															
04.63	Event word 1 bit 11 code	Default fault 7121 Motor stall.	7121h															
04.65	Event word 1 bit 12 code	Default fault 4110 Control board temperature.	4110h															
04.67	Event word 1 bit 13 code	Default fault 9081 External fault 1.	9081h															
04.69	Event word 1 bit 14 code	Default fault 9082 External fault 2.	9082h															

No.	Name/Value	Description	Def/FbEq16
04.71	<i>Event word 1 bit 15 code</i>	Selects the hexadecimal code of an event (warning, fault or pure event) whose status is shown as bit 15 of <i>04.40 Event word 1</i> . The events are listed in chapter <i>Fault tracing</i> (page 187). Default fault 2330 Earth leakage.	2330h
	0000h...FFFFh	Code of event.	1 = 1
05 Diagnostics		Various run-time-type counters and measurements related to drive maintenance. All parameters in this group are read-only unless otherwise noted.	
05.01	<i>On-time counter</i>	On-time counter. The counter runs when the drive is powered.	-
	0...65535 d	On-time counter.	1 = 1 d
05.02	<i>Run-time counter</i>	Motor run-time counter in full days. The counter runs when the inverter modulates.	-
	0...65535 d	Motor run-time counter.	1 = 1 d
05.03	<i>Hours run</i>	Corresponding parameter to <i>05.02 Run-time counter</i> in hours, that is, 24 * <i>05.02</i> value + fractional part of a day.	-
	0.0... 429496729.5 h	Hours.	1 = 1 h
05.04	<i>Fan on-time counter</i>	Running time of the drive cooling fan. Can be reset from the control panel by pressing the Reset softkey for 3 seconds.	-
	0...65535 d	Cooling fan run-time counter.	1 = 1 d
05.08	<i>Cabinet temperature</i>	<i>(Only visible for ACQ580-07 cabinet drives).</i> Temperature inside the cabinet. Activated by bit 6 of parameter <i>95.21 HW options word 2</i> .	-
	-40... 120 °C or °F	Temperature inside the cabinet in degrees Celsius or Fahrenheit.	1 = 1 unit
05.10	<i>Control board temperature</i>	Measured temperature of the control board.	-
	-100... 300 °C or °F	Control board temperature in degrees Celsius or Fahrenheit.	1 = 1 unit
05.11	<i>Inverter temperature</i>	Estimated drive temperature in percent of fault limit. The fault limit varies according to the type of the drive. 0.0% = 0 °C (32 °F) 100.0% = Fault limit	-
	-40.0...160.0%	Drive temperature in percent.	1 = 1%

No.	Name/Value	Description	Def/FbEq16																																				
05.20	<i>Diagnostic word 1</i>	Diagnostic word 1. For possible causes and remedies, see chapter Fault tracing .	-																																				
		<table border="1"> <thead> <tr> <th>Bit</th> <th>Name</th> <th>Value</th> </tr> </thead> <tbody> <tr> <td>0</td> <td>Any warning or fault</td> <td>1 = Yes = Drive has generated a warning or tripped on a fault. 0 = None active = No warning or fault active.</td> </tr> <tr> <td>1</td> <td>Any warning</td> <td>1 = Yes = Drive has generated a warning. 0 = None active = No warning active.</td> </tr> <tr> <td>2</td> <td>Any fault</td> <td>1 = Yes = Drive has tripped on a fault. 0 = None active = No fault active.</td> </tr> <tr> <td>3</td> <td>Reserved</td> <td></td> </tr> <tr> <td>4</td> <td>Overcurrent flt</td> <td>Yes = Drive has tripped on fault 2310 Overcurrent.</td> </tr> <tr> <td>5</td> <td>Reserved</td> <td></td> </tr> <tr> <td>6</td> <td>DC overvoltage</td> <td>Yes = Drive has tripped on fault 3210 DC link overvoltage.</td> </tr> <tr> <td>7</td> <td>DC undervoltage</td> <td>Yes = Drive has tripped on fault 3220 DC link undervoltage.</td> </tr> <tr> <td>8</td> <td>Reserved</td> <td></td> </tr> <tr> <td>9</td> <td>Device overtemp flt</td> <td>Yes = Drive has tripped on fault 4310 Excess temperature.</td> </tr> <tr> <td>10...15</td> <td>Reserved</td> <td></td> </tr> </tbody> </table>	Bit	Name	Value	0	Any warning or fault	1 = Yes = Drive has generated a warning or tripped on a fault. 0 = None active = No warning or fault active.	1	Any warning	1 = Yes = Drive has generated a warning. 0 = None active = No warning active.	2	Any fault	1 = Yes = Drive has tripped on a fault. 0 = None active = No fault active.	3	Reserved		4	Overcurrent flt	Yes = Drive has tripped on fault 2310 Overcurrent .	5	Reserved		6	DC overvoltage	Yes = Drive has tripped on fault 3210 DC link overvoltage .	7	DC undervoltage	Yes = Drive has tripped on fault 3220 DC link undervoltage .	8	Reserved		9	Device overtemp flt	Yes = Drive has tripped on fault 4310 Excess temperature .	10...15	Reserved		
Bit	Name	Value																																					
0	Any warning or fault	1 = Yes = Drive has generated a warning or tripped on a fault. 0 = None active = No warning or fault active.																																					
1	Any warning	1 = Yes = Drive has generated a warning. 0 = None active = No warning active.																																					
2	Any fault	1 = Yes = Drive has tripped on a fault. 0 = None active = No fault active.																																					
3	Reserved																																						
4	Overcurrent flt	Yes = Drive has tripped on fault 2310 Overcurrent .																																					
5	Reserved																																						
6	DC overvoltage	Yes = Drive has tripped on fault 3210 DC link overvoltage .																																					
7	DC undervoltage	Yes = Drive has tripped on fault 3220 DC link undervoltage .																																					
8	Reserved																																						
9	Device overtemp flt	Yes = Drive has tripped on fault 4310 Excess temperature .																																					
10...15	Reserved																																						
	0000h...FFFFh	Diagnostic word 1.	1 = 1																																				
05.21	<i>Diagnostic word 2</i>	Diagnostic word 2. For possible causes and remedies, see chapter Fault tracing .	-																																				
		<table border="1"> <thead> <tr> <th>Bit</th> <th>Name</th> <th>Value</th> </tr> </thead> <tbody> <tr> <td>0...9</td> <td>Reserved</td> <td></td> </tr> <tr> <td>10</td> <td>Motor overtemp flt</td> <td>Yes = Drive has tripped on fault 4981 External temperature 1 or 4982 External temperature 2.</td> </tr> <tr> <td>11...15</td> <td>Reserved</td> <td></td> </tr> </tbody> </table>	Bit	Name	Value	0...9	Reserved		10	Motor overtemp flt	Yes = Drive has tripped on fault 4981 External temperature 1 or 4982 External temperature 2 .	11...15	Reserved																										
Bit	Name	Value																																					
0...9	Reserved																																						
10	Motor overtemp flt	Yes = Drive has tripped on fault 4981 External temperature 1 or 4982 External temperature 2 .																																					
11...15	Reserved																																						
	0000h...FFFFh	Diagnostic word 2.	1 = 1																																				
05.22	<i>Diagnostic word 3</i>	Diagnostic word 3	-																																				
		<table border="1"> <thead> <tr> <th>Bit</th> <th>Name</th> <th>Value</th> </tr> </thead> <tbody> <tr> <td>0...8</td> <td>Reserved</td> <td></td> </tr> <tr> <td>9</td> <td>kWh pulse</td> <td>Yes = kWh pulse is active.</td> </tr> <tr> <td>10</td> <td>Reserved</td> <td></td> </tr> <tr> <td>11</td> <td>Fan command</td> <td>On = Drive fan is rotating above idle speed.</td> </tr> <tr> <td>12...15</td> <td>Reserved</td> <td></td> </tr> </tbody> </table>	Bit	Name	Value	0...8	Reserved		9	kWh pulse	Yes = kWh pulse is active.	10	Reserved		11	Fan command	On = Drive fan is rotating above idle speed.	12...15	Reserved																				
Bit	Name	Value																																					
0...8	Reserved																																						
9	kWh pulse	Yes = kWh pulse is active.																																					
10	Reserved																																						
11	Fan command	On = Drive fan is rotating above idle speed.																																					
12...15	Reserved																																						
	0000h...FFFFh	Diagnostic word 3.	1 = 1																																				
05.80	<i>Motor speed at fault</i>	Copy of parameter 01.01 Motor speed used at the occurrence of the latest fault. Parameters 05.80...05.89 are shown for each fault in the fault log.	-																																				
	-30000.00... 30000.00 rpm	Estimated motor speed.	1 = 1 rpm																																				

No.	Name/Value	Description	Def/FbEq16
05.81	<i>Output frequency at fault</i>	Copy of parameter <i>01.06 Output frequency</i> at the occurrence of the latest fault.	-
	-500.00...500.00 Hz	Estimated output frequency.	1 = 1 Hz
05.82	<i>DC voltage at fault</i>	Copy of parameter <i>01.11 DC voltage</i> at the occurrence of the latest fault.	-
	0.00...2000.00 V	DC link voltage.	10 = 1 V
05.83	<i>Motor current at fault</i>	Copy of parameter <i>01.07 Motor current</i> at the occurrence of the latest fault.	-
	0.00...30000.00 A	Motor current.	1 = 1 A
05.84	<i>Motor torque at fault</i>	Copy of parameter <i>01.10 Motor torque</i> at the occurrence of the latest fault.	-
	-1600.0...1600.0%	Motor torque.	1 = 1 %
05.85	<i>Main status word at fault</i>	Copy of parameter <i>06.11 Main status word</i> at the occurrence of the latest fault.	-
	0000h...FFFFh	Main status word.	1 = 1
05.86	<i>DI delayed status at fault</i>	Copy of parameter <i>10.02 DI delayed status</i> at the occurrence of the latest fault.	-
	0000h...FFFFh	Delayed status for digital inputs.	1 = 1
05.87	<i>Inverter temperature at fault</i>	Copy of parameter <i>05.11 Inverter temperature</i> at the occurrence of the latest fault.	-
	-40...160 °C	Drive temperature in °C.	1 = 1
05.88	<i>Reference used at fault</i>	Copy of parameter <i>28.01 Frequency ref ramp input</i> (in scalar control mode) or <i>23.01 Speed ref ramp input</i> (in speed control mode) at the occurrence of the latest fault.	-
	-500.00... 500.00 Hz or -30000.00... 30000.00 rpm	Frequency or speed reference.	1 = 1
05.89	<i>Hand-off-auto status word at fault</i>	Copy of parameter <i>06.22 Hand-off-auto status word</i> at the occurrence of the latest fault.	-
	0000h...FFFFh	ACQ580 specific status word.	1 = 1
05.111	<i>Line converter temperature</i>	<i>(Only visible for ACQ580-31 and ACQ580-34).</i> Estimated supply unit temperature in percent of fault limit. 0.0% = 0 °C (32 °F) 94% approx. = Warning limit 100.0% = Fault limit	-
	-40.0 ... 160.0%	Supply unit temperature in percent.	1 = 1%
05.121	<i>MCB closing counter</i>	<i>(Only visible for ACQ580-31 and ACQ580-34).</i> Counts the closures of the main circuit breaker of the supply unit.	-
	0...4294967295	Count of closures of main circuit breaker.	1 = 1

No.	Name/Value	Description	Def/FbEq16																																		
06 Control and status words		Drive control and status words.																																			
06.01	<i>Main control word</i>	<p>The main control word of the drive. This parameter shows the control signals as received from the selected sources (such as digital inputs, the fieldbus interfaces and the application program).</p> <p>For the control word bit descriptions see page 258. The related status word and state diagram are presented on pages 259 and 260 respectively.</p> <p>This parameter is read-only.</p> <p>Note: When using fieldbus control, this parameter value is not the same as the Control word value that the drive receives from the PLC. For the exact value, see 50.12 FBA A debug mode.</p> <table border="1" data-bbox="339 549 848 1003"> <thead> <tr> <th>Bit</th> <th>Name</th> </tr> </thead> <tbody> <tr><td>0</td><td><i>Off1 control</i></td></tr> <tr><td>1</td><td><i>Off2 control</i></td></tr> <tr><td>2</td><td><i>Off3 control</i></td></tr> <tr><td>3</td><td><i>Run</i></td></tr> <tr><td>4</td><td><i>Ramp out zero</i></td></tr> <tr><td>5</td><td><i>Ramp hold</i></td></tr> <tr><td>6</td><td><i>Ramp in zero</i></td></tr> <tr><td>7</td><td><i>Reset</i></td></tr> <tr><td>8</td><td>Reserved</td></tr> <tr><td>9</td><td>Reserved</td></tr> <tr><td>10</td><td><i>Remote cmd</i></td></tr> <tr><td>11</td><td><i>Ext ctrl loc</i></td></tr> <tr><td>12</td><td><i>User bit 0</i></td></tr> <tr><td>13</td><td><i>User bit 1</i></td></tr> <tr><td>14</td><td><i>User bit 2</i></td></tr> <tr><td>15</td><td><i>User bit 3</i></td></tr> </tbody> </table>	Bit	Name	0	<i>Off1 control</i>	1	<i>Off2 control</i>	2	<i>Off3 control</i>	3	<i>Run</i>	4	<i>Ramp out zero</i>	5	<i>Ramp hold</i>	6	<i>Ramp in zero</i>	7	<i>Reset</i>	8	Reserved	9	Reserved	10	<i>Remote cmd</i>	11	<i>Ext ctrl loc</i>	12	<i>User bit 0</i>	13	<i>User bit 1</i>	14	<i>User bit 2</i>	15	<i>User bit 3</i>	-
Bit	Name																																				
0	<i>Off1 control</i>																																				
1	<i>Off2 control</i>																																				
2	<i>Off3 control</i>																																				
3	<i>Run</i>																																				
4	<i>Ramp out zero</i>																																				
5	<i>Ramp hold</i>																																				
6	<i>Ramp in zero</i>																																				
7	<i>Reset</i>																																				
8	Reserved																																				
9	Reserved																																				
10	<i>Remote cmd</i>																																				
11	<i>Ext ctrl loc</i>																																				
12	<i>User bit 0</i>																																				
13	<i>User bit 1</i>																																				
14	<i>User bit 2</i>																																				
15	<i>User bit 3</i>																																				
0000h...FFFFh		Main control word.	1 = 1																																		

No.	Name/Value	Description	Def/FbEq16																																		
06.11	<i>Main status word</i>	<p>Main status word of the drive.</p> <p>For the status word bit descriptions see page 259. The related control word and state diagram are presented on pages 258 and 260 respectively.</p> <p>This parameter is read-only.</p> <p>Note: When using fieldbus control, this parameter value is not the same as the Status word value that the drive sends to the PLC. For the exact value, see 50.12 <i>FBA A debug mode</i>.</p> <table border="1" data-bbox="393 387 902 842"> <thead> <tr> <th data-bbox="393 387 468 411">Bit</th> <th data-bbox="468 387 902 411">Name</th> </tr> </thead> <tbody> <tr><td data-bbox="393 411 468 435">0</td><td data-bbox="468 411 902 435"><i>Ready to switch ON</i></td></tr> <tr><td data-bbox="393 435 468 459">1</td><td data-bbox="468 435 902 459"><i>Ready run</i></td></tr> <tr><td data-bbox="393 459 468 483">2</td><td data-bbox="468 459 902 483"><i>Ready ref</i></td></tr> <tr><td data-bbox="393 483 468 507">3</td><td data-bbox="468 483 902 507"><i>Tripped</i></td></tr> <tr><td data-bbox="393 507 468 531">4</td><td data-bbox="468 507 902 531"><i>Off 2 inactive</i></td></tr> <tr><td data-bbox="393 531 468 555">5</td><td data-bbox="468 531 902 555"><i>Off 3 inactive</i></td></tr> <tr><td data-bbox="393 555 468 579">6</td><td data-bbox="468 555 902 579"><i>Switch-on inhibited</i></td></tr> <tr><td data-bbox="393 579 468 603">7</td><td data-bbox="468 579 902 603"><i>Warning</i></td></tr> <tr><td data-bbox="393 603 468 627">8</td><td data-bbox="468 603 902 627"><i>At setpoint</i></td></tr> <tr><td data-bbox="393 627 468 651">9</td><td data-bbox="468 627 902 651"><i>Remote</i></td></tr> <tr><td data-bbox="393 651 468 675">10</td><td data-bbox="468 651 902 675"><i>Above limit</i></td></tr> <tr><td data-bbox="393 675 468 699">11</td><td data-bbox="468 675 902 699"><i>User bit 0</i></td></tr> <tr><td data-bbox="393 699 468 722">12</td><td data-bbox="468 699 902 722"><i>User bit 1</i></td></tr> <tr><td data-bbox="393 722 468 746">13</td><td data-bbox="468 722 902 746"><i>User bit 2</i></td></tr> <tr><td data-bbox="393 746 468 770">14</td><td data-bbox="468 746 902 770"><i>User bit 3</i></td></tr> <tr><td data-bbox="393 770 468 794">15</td><td data-bbox="468 770 902 794"><i>Reserved</i></td></tr> </tbody> </table>	Bit	Name	0	<i>Ready to switch ON</i>	1	<i>Ready run</i>	2	<i>Ready ref</i>	3	<i>Tripped</i>	4	<i>Off 2 inactive</i>	5	<i>Off 3 inactive</i>	6	<i>Switch-on inhibited</i>	7	<i>Warning</i>	8	<i>At setpoint</i>	9	<i>Remote</i>	10	<i>Above limit</i>	11	<i>User bit 0</i>	12	<i>User bit 1</i>	13	<i>User bit 2</i>	14	<i>User bit 3</i>	15	<i>Reserved</i>	-
Bit	Name																																				
0	<i>Ready to switch ON</i>																																				
1	<i>Ready run</i>																																				
2	<i>Ready ref</i>																																				
3	<i>Tripped</i>																																				
4	<i>Off 2 inactive</i>																																				
5	<i>Off 3 inactive</i>																																				
6	<i>Switch-on inhibited</i>																																				
7	<i>Warning</i>																																				
8	<i>At setpoint</i>																																				
9	<i>Remote</i>																																				
10	<i>Above limit</i>																																				
11	<i>User bit 0</i>																																				
12	<i>User bit 1</i>																																				
13	<i>User bit 2</i>																																				
14	<i>User bit 3</i>																																				
15	<i>Reserved</i>																																				
	0000h...FFFFh	Main status word.	1 = 1																																		

No.	Name/Value	Description	Def/FbEq16																																																			
06.16	Drive status word 1	Drive status word 1. This parameter is read-only.	-																																																			
<table border="1"> <thead> <tr> <th>Bit</th> <th>Name</th> <th>Description</th> </tr> </thead> <tbody> <tr> <td>0</td> <td>Enabled</td> <td>1 = If start interlock signals (par. 20.41...20.44) are all present. Note: This bit is not affected by the presence of a fault.</td> </tr> <tr> <td>1</td> <td>Inhibited</td> <td>1 = Start inhibited. To start the drive, the inhibiting signal (see par. 06.18) must be removed and the start signal cycled.</td> </tr> <tr> <td>2</td> <td>DC charged</td> <td>1 = DC circuit has been charged</td> </tr> <tr> <td>3</td> <td>Ready to start</td> <td>1 = Drive is ready to receive a start command</td> </tr> <tr> <td>4</td> <td>Following reference</td> <td>1 = Drive is ready to follow given reference</td> </tr> <tr> <td>5</td> <td>Started</td> <td>1 = Drive has been started</td> </tr> <tr> <td>6</td> <td>Modulating</td> <td>1 = Drive is modulating (output stage is being controlled)</td> </tr> <tr> <td>7</td> <td>Limiting</td> <td>1 = Any operating limit (speed, torque, etc.) is active</td> </tr> <tr> <td>8</td> <td>Local control</td> <td>1 = Drive is in local control</td> </tr> <tr> <td>9</td> <td>Network control</td> <td>1 = Drive is in <i>network control</i> (see page 19).</td> </tr> <tr> <td>10</td> <td>Ext1 active</td> <td>1 = Control location EXT1 active</td> </tr> <tr> <td>11</td> <td>Ext2 active</td> <td>1 = Control location EXT2 active</td> </tr> <tr> <td>12</td> <td>Reserved</td> <td></td> </tr> <tr> <td>13</td> <td>Start request</td> <td>1 = If Start requested. 0 = When Run permissive signal (see par. 20.40) is 0.</td> </tr> <tr> <td>14</td> <td>Running</td> <td>1 = Drive is controlling speed or frequency, in PID sleep or pre-magnetization.</td> </tr> <tr> <td>15</td> <td>Reserved</td> <td></td> </tr> </tbody> </table>				Bit	Name	Description	0	Enabled	1 = If start interlock signals (par. 20.41...20.44) are all present. Note: This bit is not affected by the presence of a fault.	1	Inhibited	1 = Start inhibited. To start the drive, the inhibiting signal (see par. 06.18) must be removed and the start signal cycled.	2	DC charged	1 = DC circuit has been charged	3	Ready to start	1 = Drive is ready to receive a start command	4	Following reference	1 = Drive is ready to follow given reference	5	Started	1 = Drive has been started	6	Modulating	1 = Drive is modulating (output stage is being controlled)	7	Limiting	1 = Any operating limit (speed, torque, etc.) is active	8	Local control	1 = Drive is in local control	9	Network control	1 = Drive is in <i>network control</i> (see page 19).	10	Ext1 active	1 = Control location EXT1 active	11	Ext2 active	1 = Control location EXT2 active	12	Reserved		13	Start request	1 = If Start requested. 0 = When Run permissive signal (see par. 20.40) is 0.	14	Running	1 = Drive is controlling speed or frequency, in PID sleep or pre-magnetization.	15	Reserved	
Bit	Name	Description																																																				
0	Enabled	1 = If start interlock signals (par. 20.41...20.44) are all present. Note: This bit is not affected by the presence of a fault.																																																				
1	Inhibited	1 = Start inhibited. To start the drive, the inhibiting signal (see par. 06.18) must be removed and the start signal cycled.																																																				
2	DC charged	1 = DC circuit has been charged																																																				
3	Ready to start	1 = Drive is ready to receive a start command																																																				
4	Following reference	1 = Drive is ready to follow given reference																																																				
5	Started	1 = Drive has been started																																																				
6	Modulating	1 = Drive is modulating (output stage is being controlled)																																																				
7	Limiting	1 = Any operating limit (speed, torque, etc.) is active																																																				
8	Local control	1 = Drive is in local control																																																				
9	Network control	1 = Drive is in <i>network control</i> (see page 19).																																																				
10	Ext1 active	1 = Control location EXT1 active																																																				
11	Ext2 active	1 = Control location EXT2 active																																																				
12	Reserved																																																					
13	Start request	1 = If Start requested. 0 = When Run permissive signal (see par. 20.40) is 0.																																																				
14	Running	1 = Drive is controlling speed or frequency, in PID sleep or pre-magnetization.																																																				
15	Reserved																																																					
0000h...FFFFh		Drive status word 1.	1 = 1																																																			

No.	Name/Value	Description	Def/FbEq16																																													
06.17	Drive status word 2	Drive status word 2. This parameter is read-only.	-																																													
<table border="1"> <thead> <tr> <th>Bit</th> <th>Name</th> <th>Description</th> </tr> </thead> <tbody> <tr> <td>0</td> <td>Identification run done</td> <td>1 = Motor identification (ID) run has been performed</td> </tr> <tr> <td>1</td> <td>Magnetized</td> <td>1 = The motor has been magnetized</td> </tr> <tr> <td>2</td> <td>Reserved</td> <td></td> </tr> <tr> <td>3</td> <td>Speed control</td> <td>1 = Speed control mode active</td> </tr> <tr> <td>4</td> <td>Reserved</td> <td></td> </tr> <tr> <td>5</td> <td>Safe reference active</td> <td>1 = A "safe" reference is applied by functions such as parameters 49.05 and 50.02</td> </tr> <tr> <td>6</td> <td>Last speed active</td> <td>1 = A "last speed" reference is applied by functions such as parameters 49.05 and 50.02</td> </tr> <tr> <td>7</td> <td>Reserved</td> <td></td> </tr> <tr> <td>8</td> <td>Emergency stop failed</td> <td>1 = Emergency stop failed (see parameters 31.32 and 31.33)</td> </tr> <tr> <td>9</td> <td>Reserved</td> <td></td> </tr> <tr> <td>10</td> <td>Above limit</td> <td>1 = Actual speed or frequency equals or exceeds limit (defined by parameters 46.31...46.32). Valid in both directions of rotation.</td> </tr> <tr> <td>11...12</td> <td>Reserved</td> <td></td> </tr> <tr> <td>13</td> <td>Start delay active</td> <td>1 = Start delay (par. 21.22) active</td> </tr> <tr> <td>14...15</td> <td>Reserved</td> <td></td> </tr> </tbody> </table>				Bit	Name	Description	0	Identification run done	1 = Motor identification (ID) run has been performed	1	Magnetized	1 = The motor has been magnetized	2	Reserved		3	Speed control	1 = Speed control mode active	4	Reserved		5	Safe reference active	1 = A "safe" reference is applied by functions such as parameters 49.05 and 50.02	6	Last speed active	1 = A "last speed" reference is applied by functions such as parameters 49.05 and 50.02	7	Reserved		8	Emergency stop failed	1 = Emergency stop failed (see parameters 31.32 and 31.33)	9	Reserved		10	Above limit	1 = Actual speed or frequency equals or exceeds limit (defined by parameters 46.31 ... 46.32). Valid in both directions of rotation.	11...12	Reserved		13	Start delay active	1 = Start delay (par. 21.22) active	14...15	Reserved	
Bit	Name	Description																																														
0	Identification run done	1 = Motor identification (ID) run has been performed																																														
1	Magnetized	1 = The motor has been magnetized																																														
2	Reserved																																															
3	Speed control	1 = Speed control mode active																																														
4	Reserved																																															
5	Safe reference active	1 = A "safe" reference is applied by functions such as parameters 49.05 and 50.02																																														
6	Last speed active	1 = A "last speed" reference is applied by functions such as parameters 49.05 and 50.02																																														
7	Reserved																																															
8	Emergency stop failed	1 = Emergency stop failed (see parameters 31.32 and 31.33)																																														
9	Reserved																																															
10	Above limit	1 = Actual speed or frequency equals or exceeds limit (defined by parameters 46.31 ... 46.32). Valid in both directions of rotation.																																														
11...12	Reserved																																															
13	Start delay active	1 = Start delay (par. 21.22) active																																														
14...15	Reserved																																															
0000h...FFFFh	Drive status word 2.		1 = 1																																													

No.	Name/Value	Description	Def/FbEq16
06.18	<i>Start inhibit status word</i>	Start inhibit status word. This word specifies the source of the inhibiting signal that is preventing the drive from starting. The conditions marked with an asterisk (*) only require that the start command is cycled. In all other instances, the inhibiting condition must be removed first. See also parameter <i>06.16 Drive status word 1</i> , bit 1. This parameter is read-only.	-

Bit	Name	Description
0	Not ready run	1 = DC voltage is missing or drive has not been parametrized correctly. Check the parameters in groups 95 and 99.
1	Ctrl location changed	* 1 = Control location has changed
2	SSW inhibit	1 = Control program is keeping itself in inhibited state
3	Fault reset	* 1 = A fault has been reset
4	Start interlocked	1 = Start interlocked
5	Run permissive	1 = Run permissive signal missing
6	Reserved	
7	STO	1 = Safe torque off function active
8	Current calibration ended	* 1 = Current calibration routine has finished
9	ID run ended	* 1 = Motor identification run has finished
10	Reserved	
11	Em Off1	1 = Emergency stop signal (mode off1)
12	Em Off2	1 = Emergency stop signal (mode off2)
13	Em Off3	1 = Emergency stop signal (mode off3)
14	Auto reset inhibit	1 = The autoreset function is inhibiting operation
15	Reserved	

0000h...FFFFh	Start inhibit status word.	1 = 1
---------------	----------------------------	-------

06.19	<i>Speed control status word</i>	Speed control status word. This parameter is read-only.	-
-------	----------------------------------	---	---

Bit	Name	Description
0	Zero speed	1 = Drive has been running below zero speed limit (par. 21.06) for a time defined by parameter 21.07 Zero speed delay
1	Forward	1 = Drive is running in forward direction above zero speed limit (par. 21.06)
2	Reverse	1 = Drive is running in reverse direction above zero speed limit (par. 21.06)
3...6	Reserved	
7	Any constant speed request	1 = A constant speed or frequency has been selected; see par. 06.20
8...15	Reserved	

0000h...FFFFh	Speed control status word.	1 = 1
---------------	----------------------------	-------

No.	Name/Value	Description	Def/FbEq16																											
06.20	<i>Constant speed status word</i>	Constant speed/frequency status word. Indicates which constant speed or frequency is active (if any). See also parameter 06.19 Speed control status word , bit 7, and section Constant speeds/frequencies (page 181). This parameter is read-only.	-																											
<table border="1"> <thead> <tr> <th>Bit</th> <th>Name</th> <th>Description</th> </tr> </thead> <tbody> <tr> <td>0</td> <td>Constant speed 1</td> <td>1 = Constant speed or frequency 1 selected</td> </tr> <tr> <td>1</td> <td>Constant speed 2</td> <td>1 = Constant speed or frequency 2 selected</td> </tr> <tr> <td>2</td> <td>Constant speed 3</td> <td>1 = Constant speed or frequency 3 selected</td> </tr> <tr> <td>3</td> <td>Constant speed 4</td> <td>1 = Constant speed or frequency 4 selected</td> </tr> <tr> <td>4</td> <td>Constant speed 5</td> <td>1 = Constant speed or frequency 5 selected</td> </tr> <tr> <td>5</td> <td>Constant speed 6</td> <td>1 = Constant speed or frequency 6 selected</td> </tr> <tr> <td>6</td> <td>Constant speed 7</td> <td>1 = Constant speed or frequency 7 selected</td> </tr> <tr> <td>7...15</td> <td>Reserved</td> <td></td> </tr> </tbody> </table>				Bit	Name	Description	0	Constant speed 1	1 = Constant speed or frequency 1 selected	1	Constant speed 2	1 = Constant speed or frequency 2 selected	2	Constant speed 3	1 = Constant speed or frequency 3 selected	3	Constant speed 4	1 = Constant speed or frequency 4 selected	4	Constant speed 5	1 = Constant speed or frequency 5 selected	5	Constant speed 6	1 = Constant speed or frequency 6 selected	6	Constant speed 7	1 = Constant speed or frequency 7 selected	7...15	Reserved	
Bit	Name	Description																												
0	Constant speed 1	1 = Constant speed or frequency 1 selected																												
1	Constant speed 2	1 = Constant speed or frequency 2 selected																												
2	Constant speed 3	1 = Constant speed or frequency 3 selected																												
3	Constant speed 4	1 = Constant speed or frequency 4 selected																												
4	Constant speed 5	1 = Constant speed or frequency 5 selected																												
5	Constant speed 6	1 = Constant speed or frequency 6 selected																												
6	Constant speed 7	1 = Constant speed or frequency 7 selected																												
7...15	Reserved																													
	0000h...FFFFh	Constant speed/frequency status word.	1 = 1																											
06.21	<i>Drive status word 3</i>	Drive status word 3. This parameter is read-only.	-																											
<table border="1"> <thead> <tr> <th>Bit</th> <th>Name</th> <th>Description</th> </tr> </thead> <tbody> <tr> <td>0</td> <td>DC hold active</td> <td>1 = DC hold is active</td> </tr> <tr> <td>1</td> <td>Post-magnetizing active</td> <td>1 = Post-magnetizing is active</td> </tr> <tr> <td>2</td> <td>Motor pre-heating active</td> <td>1 = Motor pre-heating is active</td> </tr> <tr> <td>3</td> <td>PM smooth start active</td> <td>1 = PM smooth start active</td> </tr> <tr> <td>4...15</td> <td>Reserved</td> <td></td> </tr> </tbody> </table>				Bit	Name	Description	0	DC hold active	1 = DC hold is active	1	Post-magnetizing active	1 = Post-magnetizing is active	2	Motor pre-heating active	1 = Motor pre-heating is active	3	PM smooth start active	1 = PM smooth start active	4...15	Reserved										
Bit	Name	Description																												
0	DC hold active	1 = DC hold is active																												
1	Post-magnetizing active	1 = Post-magnetizing is active																												
2	Motor pre-heating active	1 = Motor pre-heating is active																												
3	PM smooth start active	1 = PM smooth start active																												
4...15	Reserved																													
	0000h...FFFFh	Drive status word 1.	1 = 1																											

No.	Name/Value	Description	Def/FbEq16																																										
06.22	<i>Hand-off-auto status word</i>	ACQ580 specific status word. This parameter is read-only.	-																																										
		<table border="1"> <thead> <tr> <th>Bit</th> <th>Name</th> <th>Description</th> </tr> </thead> <tbody> <tr> <td>0</td> <td>Hand mode</td> <td>0 = Drive is not operated from the control panel in the Hand mode; 1 = Drive is operated from the control panel in the Hand mode.</td> </tr> <tr> <td>1</td> <td>Off mode</td> <td>0 = Drive is not in the Off mode; 1 = Drive is in the Off mode.</td> </tr> <tr> <td>2</td> <td>Auto mode</td> <td>0 = Drive is not in the Auto mode; 1 = Drive is in the Auto mode.</td> </tr> <tr> <td>3</td> <td>Reserved</td> <td></td> </tr> <tr> <td>4</td> <td>Pre-heating</td> <td>0 = Motor pre-heating is not active; 1 = Motor pre-heating is active.</td> </tr> <tr> <td>5...6</td> <td>Reserved</td> <td></td> </tr> <tr> <td>7</td> <td>Run permissive</td> <td>0 = Run permissive is not present, drive is not allowed to run; 1 = Run permissive is present, drive is allowed to run.</td> </tr> <tr> <td>8</td> <td>Start interlock 1</td> <td>0 = Start interlock 1 is not present, drive is not allowed to start; 1 = Start interlock 1 is present, drive is allowed to start.</td> </tr> <tr> <td>9</td> <td>Start interlock 2</td> <td>0 = Start interlock 2 is not present, drive is not allowed to start; 1 = Start interlock 2 is present, drive is allowed to start.</td> </tr> <tr> <td>10</td> <td>Start interlock 3</td> <td>0 = Start interlock 3 is not present, drive is not allowed to start; 1 = Start interlock 3 is present, drive is allowed to start.</td> </tr> <tr> <td>11</td> <td>Start interlock 4</td> <td>0 = Start interlock 4 is not present, drive is not allowed to start; 1 = Start interlock 4 is present, drive is allowed to start.</td> </tr> <tr> <td>12</td> <td>All start interlocks</td> <td>0 = One or more of Start interlock 1, Start interlock 2, Start interlock 3 or Start interlock 4 is not present, drive is not allowed to start; 1 = Start interlock 1 and Start interlock 2 and Start interlock 3 and Start interlock 4 are all present, drive is allowed to start.</td> </tr> <tr> <td>13...15</td> <td>Reserved</td> <td></td> </tr> </tbody> </table>	Bit	Name	Description	0	Hand mode	0 = Drive is not operated from the control panel in the Hand mode; 1 = Drive is operated from the control panel in the Hand mode.	1	Off mode	0 = Drive is not in the Off mode; 1 = Drive is in the Off mode.	2	Auto mode	0 = Drive is not in the Auto mode; 1 = Drive is in the Auto mode.	3	Reserved		4	Pre-heating	0 = Motor pre-heating is not active; 1 = Motor pre-heating is active.	5...6	Reserved		7	Run permissive	0 = Run permissive is not present, drive is not allowed to run; 1 = Run permissive is present, drive is allowed to run.	8	Start interlock 1	0 = Start interlock 1 is not present, drive is not allowed to start; 1 = Start interlock 1 is present, drive is allowed to start.	9	Start interlock 2	0 = Start interlock 2 is not present, drive is not allowed to start; 1 = Start interlock 2 is present, drive is allowed to start.	10	Start interlock 3	0 = Start interlock 3 is not present, drive is not allowed to start; 1 = Start interlock 3 is present, drive is allowed to start.	11	Start interlock 4	0 = Start interlock 4 is not present, drive is not allowed to start; 1 = Start interlock 4 is present, drive is allowed to start.	12	All start interlocks	0 = One or more of Start interlock 1, Start interlock 2, Start interlock 3 or Start interlock 4 is not present, drive is not allowed to start; 1 = Start interlock 1 and Start interlock 2 and Start interlock 3 and Start interlock 4 are all present, drive is allowed to start.	13...15	Reserved		
Bit	Name	Description																																											
0	Hand mode	0 = Drive is not operated from the control panel in the Hand mode; 1 = Drive is operated from the control panel in the Hand mode.																																											
1	Off mode	0 = Drive is not in the Off mode; 1 = Drive is in the Off mode.																																											
2	Auto mode	0 = Drive is not in the Auto mode; 1 = Drive is in the Auto mode.																																											
3	Reserved																																												
4	Pre-heating	0 = Motor pre-heating is not active; 1 = Motor pre-heating is active.																																											
5...6	Reserved																																												
7	Run permissive	0 = Run permissive is not present, drive is not allowed to run; 1 = Run permissive is present, drive is allowed to run.																																											
8	Start interlock 1	0 = Start interlock 1 is not present, drive is not allowed to start; 1 = Start interlock 1 is present, drive is allowed to start.																																											
9	Start interlock 2	0 = Start interlock 2 is not present, drive is not allowed to start; 1 = Start interlock 2 is present, drive is allowed to start.																																											
10	Start interlock 3	0 = Start interlock 3 is not present, drive is not allowed to start; 1 = Start interlock 3 is present, drive is allowed to start.																																											
11	Start interlock 4	0 = Start interlock 4 is not present, drive is not allowed to start; 1 = Start interlock 4 is present, drive is allowed to start.																																											
12	All start interlocks	0 = One or more of Start interlock 1, Start interlock 2, Start interlock 3 or Start interlock 4 is not present, drive is not allowed to start; 1 = Start interlock 1 and Start interlock 2 and Start interlock 3 and Start interlock 4 are all present, drive is allowed to start.																																											
13...15	Reserved																																												
	0000h...FFFFh		1 = 1																																										
06.29	<i>MSW bit 10 selection</i>	Selects a binary source whose status is transmitted as bit 10 (User bit 0) of <i>06.11 Main status word</i> .	<i>Above limit</i>																																										
	False	0.	0																																										
	True	1.	1																																										
	Above limit	Bit 10 of <i>06.17 Drive status word 2</i> (see page 301).	2																																										
	<i>Other [bit]</i>	Source selection (see <i>Terms and abbreviations</i> on page 285).	-																																										
06.30	<i>MSW bit 11 selection</i>	Selects a binary source whose status is transmitted as bit 11 (User bit 0) of <i>06.11 Main status word</i> .	<i>Ext ctrl loc</i>																																										
	False	0.	0																																										
	True	1.	1																																										
	Ext ctrl loc	Bit 11 of <i>06.01 Main control word</i> (see page 299).	2																																										
	<i>Other [bit]</i>	Source selection (see <i>Terms and abbreviations</i> on page 285).	-																																										
06.31	<i>MSW bit 12 selection</i>	Selects a binary source whose status is transmitted as bit 12 (User bit 1) of <i>06.11 Main status word</i> .	<i>Run permissive</i>																																										
	False	0.	0																																										
	True	1.	1																																										
	Reserved	1.	2																																										

No.	Name/Value	Description	Def/FbEq16
	Run permissive	Bit 5 of <i>06.18 Start inhibit status word</i> status word (see page 302).	3
	<i>Other [bit]</i>	Source selection (see <i>Terms and abbreviations</i> on page 285).	-
<i>06.32</i>	<i>MSW bit 13 selection</i>	Selects a binary source whose status is transmitted as bit 13 (User bit 2) of <i>06.11 Main status word</i> .	<i>False</i>
	False	0.	0
	True	1.	1
	<i>Other [bit]</i>	Source selection (see <i>Terms and abbreviations</i> on page 285).	-
<i>06.33</i>	<i>MSW bit 14 selection</i>	Selects a binary source whose status is transmitted as bit 14 (User bit 3) of <i>06.11 Main status word</i> .	<i>False</i>
	False	0.	0
	True	1.	1
	<i>Other [bit]</i>	Source selection (see <i>Terms and abbreviations</i> on page 285).	-
<i>06.36</i>	<i>LSU Status word</i>	<i>(Only visible for ACQ580-31 and ACQ580-34).</i> Shows the status of the supply unit. See also section <i>Control of a line supply unit (LSU)</i> (page 97), and parameter group <i>60 DDCS communication</i> . This parameter is read-only.	-

Bit	Name	Description
0	Ready on	1 = Ready to switch on
1	Ready run	1 = Ready to operate, DC link charged
2	Ready ref	1 = Operation enabled
3	Tripped	1 = A fault is active
4...6	Reserved	
7	Warning	1 = A warning is active
8	Modulating	1 = The supply unit is modulating
9	Remote	1 = Remote control (EXT1 or EXT2) 0 = Local control
10	Net ok	1 = Supply network voltage OK
11...12	Reserved	
13	Charging or ready run	1 = Bit 1 or bit 14 active
14	Charging	1 = Charging circuit is active 0 = Charging circuit is not active
15	Reserved	

0000h...FFFh	Supply unit status word.	1 = 1
--------------	--------------------------	-------

No.	Name/Value	Description	Def/FbEq16																																																
06.39	<i>Internal state machine LSU CW</i>	<i>(Only visible for ACQ580-31 and ACQ580-34).</i> Shows the control word sent to the supply unit from the INU-LSU (inverter unit/supply unit) state machine. This parameter is read-only.	-																																																
<table border="1"> <thead> <tr> <th>Bit</th> <th>Name</th> <th>Description</th> </tr> </thead> <tbody> <tr> <td>0</td> <td>ON/OFF</td> <td>1 = Start charging 0 = Open main contactor (switch power off)</td> </tr> <tr> <td>1</td> <td>OFF 2</td> <td>0 = Emergency stop (Off2)</td> </tr> <tr> <td>2</td> <td>OFF 3</td> <td>0 = Emergency stop (Off3)</td> </tr> <tr> <td>3</td> <td>START</td> <td>1 = Start modulating 0 = Stop modulating</td> </tr> <tr> <td>4...6</td> <td>Reserved</td> <td></td> </tr> <tr> <td>7</td> <td>RESET</td> <td>0 -> 1 = Reset an active fault. A fresh start command is required after reset.</td> </tr> <tr> <td>8...15</td> <td>Reserved</td> <td></td> </tr> </tbody> </table>				Bit	Name	Description	0	ON/OFF	1 = Start charging 0 = Open main contactor (switch power off)	1	OFF 2	0 = Emergency stop (Off2)	2	OFF 3	0 = Emergency stop (Off3)	3	START	1 = Start modulating 0 = Stop modulating	4...6	Reserved		7	RESET	0 -> 1 = Reset an active fault. A fresh start command is required after reset.	8...15	Reserved																									
Bit	Name	Description																																																	
0	ON/OFF	1 = Start charging 0 = Open main contactor (switch power off)																																																	
1	OFF 2	0 = Emergency stop (Off2)																																																	
2	OFF 3	0 = Emergency stop (Off3)																																																	
3	START	1 = Start modulating 0 = Stop modulating																																																	
4...6	Reserved																																																		
7	RESET	0 -> 1 = Reset an active fault. A fresh start command is required after reset.																																																	
8...15	Reserved																																																		
	0000h...FFFFh	Supply unit control word.	1 = 1																																																
06.116	<i>LSU drive status word 1</i>	<i>(Only visible for ACQ580-31 and ACQ580-34).</i> Drive status word 1 received from the supply unit. See also section <i>Control of a line supply unit (LSU)</i> (page 97), and parameter group <i>60 DDCS communication</i> . This parameter is read-only.	-																																																
<table border="1"> <thead> <tr> <th>Bit</th> <th>Name</th> <th>Description</th> </tr> </thead> <tbody> <tr> <td>0</td> <td>Enabled</td> <td>1 = Run enable and start enable signals are present</td> </tr> <tr> <td>1</td> <td>Inhibited</td> <td>1 = Start inhibited (see bit 1 of parameter <i>06.16 Drive status word 1</i>)</td> </tr> <tr> <td>2</td> <td>Operation allowed</td> <td>1 = Drive is ready to operate</td> </tr> <tr> <td>3</td> <td>Ready to start</td> <td>1 = Drive is ready to receive a start command</td> </tr> <tr> <td>4</td> <td>Running</td> <td>1 = Drive is ready to follow given reference</td> </tr> <tr> <td>5</td> <td>Started</td> <td>1 = Drive has been started</td> </tr> <tr> <td>6</td> <td>Modulating</td> <td>1 = Drive is modulating (output stage is being controlled)</td> </tr> <tr> <td>7</td> <td>Limiting</td> <td>1 = Any operating limit is active</td> </tr> <tr> <td>8</td> <td>Local control</td> <td>1 = Drive is in local control</td> </tr> <tr> <td>9</td> <td>Network control</td> <td>1 = Drive is in network control</td> </tr> <tr> <td>10</td> <td>Ext1 active</td> <td>1 = Control location EXT1 active</td> </tr> <tr> <td>11</td> <td>Ext2 active</td> <td>1 = Control location EXT2 active</td> </tr> <tr> <td>12</td> <td>Charging active</td> <td>1 = Charging circuit is active 0 = Charging circuit is not active</td> </tr> <tr> <td>13</td> <td>MCB relay</td> <td>1 = MCB relay is closed</td> </tr> <tr> <td>14...15</td> <td>Reserved</td> <td></td> </tr> </tbody> </table>				Bit	Name	Description	0	Enabled	1 = Run enable and start enable signals are present	1	Inhibited	1 = Start inhibited (see bit 1 of parameter <i>06.16 Drive status word 1</i>)	2	Operation allowed	1 = Drive is ready to operate	3	Ready to start	1 = Drive is ready to receive a start command	4	Running	1 = Drive is ready to follow given reference	5	Started	1 = Drive has been started	6	Modulating	1 = Drive is modulating (output stage is being controlled)	7	Limiting	1 = Any operating limit is active	8	Local control	1 = Drive is in local control	9	Network control	1 = Drive is in network control	10	Ext1 active	1 = Control location EXT1 active	11	Ext2 active	1 = Control location EXT2 active	12	Charging active	1 = Charging circuit is active 0 = Charging circuit is not active	13	MCB relay	1 = MCB relay is closed	14...15	Reserved	
Bit	Name	Description																																																	
0	Enabled	1 = Run enable and start enable signals are present																																																	
1	Inhibited	1 = Start inhibited (see bit 1 of parameter <i>06.16 Drive status word 1</i>)																																																	
2	Operation allowed	1 = Drive is ready to operate																																																	
3	Ready to start	1 = Drive is ready to receive a start command																																																	
4	Running	1 = Drive is ready to follow given reference																																																	
5	Started	1 = Drive has been started																																																	
6	Modulating	1 = Drive is modulating (output stage is being controlled)																																																	
7	Limiting	1 = Any operating limit is active																																																	
8	Local control	1 = Drive is in local control																																																	
9	Network control	1 = Drive is in network control																																																	
10	Ext1 active	1 = Control location EXT1 active																																																	
11	Ext2 active	1 = Control location EXT2 active																																																	
12	Charging active	1 = Charging circuit is active 0 = Charging circuit is not active																																																	
13	MCB relay	1 = MCB relay is closed																																																	
14...15	Reserved																																																		
	0000h...FFFFh	Drive status word 1.	1 = 1																																																

No.	Name/Value	Description	Def/FbEq16																												
06.118	<i>LSU start inhibit status word</i>	<p>(Only visible for ACQ580-31 and ACQ580-34).</p> <p>This word specifies the source of the inhibiting condition that is preventing the supply unit from starting.</p> <p>See also section <i>Control of a line supply unit (LSU)</i> (page 97), and parameter group <i>60 DDCS communication</i>.</p> <p>This parameter is read-only.</p> <table border="1" data-bbox="397 351 904 726"> <thead> <tr> <th>Bit</th> <th>Name</th> </tr> </thead> <tbody> <tr><td>0</td><td>Not ready run</td></tr> <tr><td>1</td><td>Ctrl location changed</td></tr> <tr><td>2</td><td>SSW inhibit</td></tr> <tr><td>3</td><td>Fault reset</td></tr> <tr><td>4</td><td>Lost start enable</td></tr> <tr><td>5</td><td>Lost run enable</td></tr> <tr><td>6...8</td><td>Reserved</td></tr> <tr><td>9</td><td>Charging overload</td></tr> <tr><td>10...11</td><td>Reserved</td></tr> <tr><td>12</td><td>Em Off2</td></tr> <tr><td>13</td><td>Em Off3</td></tr> <tr><td>14</td><td>Auto reset inhibit</td></tr> <tr><td>15</td><td>Reserved</td></tr> </tbody> </table>	Bit	Name	0	Not ready run	1	Ctrl location changed	2	SSW inhibit	3	Fault reset	4	Lost start enable	5	Lost run enable	6...8	Reserved	9	Charging overload	10...11	Reserved	12	Em Off2	13	Em Off3	14	Auto reset inhibit	15	Reserved	-
Bit	Name																														
0	Not ready run																														
1	Ctrl location changed																														
2	SSW inhibit																														
3	Fault reset																														
4	Lost start enable																														
5	Lost run enable																														
6...8	Reserved																														
9	Charging overload																														
10...11	Reserved																														
12	Em Off2																														
13	Em Off3																														
14	Auto reset inhibit																														
15	Reserved																														
	0000h...FFFFh	Start inhibit status word of supply unit.	1 = 1																												
07 System info		Drive hardware and firmware information. All parameters in this group are read-only.																													
07.03	<i>Drive rating id</i>	Type of the drive. (Rating ID in brackets.)	1 = 1																												
07.04	<i>Firmware name</i>	Firmware identification.	-																												
07.05	<i>Firmware version</i>	Version number of the firmware.	-																												
07.06	<i>Loading package name</i>	Name of the firmware loading package.	-																												
07.07	<i>Loading package version</i>	Version number of the firmware loading package.	-																												
07.10	<i>Language file set</i>	The language file set (language package) in use, see parameter <i>96.01 Language</i> . The language file set value is written to this parameter after the first start-up, and it is available in this parameter through power-ups.	-																												
	Not known	No language file set in use.	0																												
	Global	Global language file set in use.	1																												
	European	European language file set in use.	2																												
	Asian	Asian language file set in use.	3																												
07.11	<i>Cpu usage</i>	Microprocessor load in percent.	-																												
	0...100%	Microprocessor load.	1 = 1%																												
07.25	<i>Customization package name</i>	First five ASCII letters of the name given to the customization package. The full name is visible under System info on the control panel or the Drive composer PC tool. _N/A_ = None.	-																												

No.	Name/Value	Description	Def/FbEq16																																										
07.26	<i>Customization package version</i>	Customization package version number. Also visible under System info on the control panel or the Drive composer PC tool.	-																																										
07.30	<i>Adaptive program status</i>	Shows the status of the adaptive program. See section <i>Adaptive programming</i> (page 92).	-																																										
<table border="1"> <thead> <tr> <th>Bit</th> <th>Name</th> <th>Description</th> </tr> </thead> <tbody> <tr> <td>0</td> <td>Initialized</td> <td>1 = Adaptive program initialized</td> </tr> <tr> <td>1</td> <td>Editing</td> <td>1 = Adaptive program is being edited</td> </tr> <tr> <td>2</td> <td>Edit done</td> <td>1 = Editing of adaptive program finished</td> </tr> <tr> <td>3</td> <td>Running</td> <td>1 = Adaptive program running</td> </tr> <tr> <td>4...13</td> <td>Reserved</td> <td></td> </tr> <tr> <td>14</td> <td>State changing</td> <td>1 = State change in progress in adaptive programming engine</td> </tr> <tr> <td>15</td> <td>Faulted</td> <td>1 = Error in adaptive program</td> </tr> </tbody> </table>				Bit	Name	Description	0	Initialized	1 = Adaptive program initialized	1	Editing	1 = Adaptive program is being edited	2	Edit done	1 = Editing of adaptive program finished	3	Running	1 = Adaptive program running	4...13	Reserved		14	State changing	1 = State change in progress in adaptive programming engine	15	Faulted	1 = Error in adaptive program																		
Bit	Name	Description																																											
0	Initialized	1 = Adaptive program initialized																																											
1	Editing	1 = Adaptive program is being edited																																											
2	Edit done	1 = Editing of adaptive program finished																																											
3	Running	1 = Adaptive program running																																											
4...13	Reserved																																												
14	State changing	1 = State change in progress in adaptive programming engine																																											
15	Faulted	1 = Error in adaptive program																																											
	0000h...FFFFh	Adaptive program status.	1 = 1																																										
07.31	<i>AP sequence state</i>	Shows the number of the active state of the sequence program part of the adaptive program (AP). If adaptive programming is not running, or it does not contain a sequence program, the parameter is zero.																																											
	0...20		1 = 1																																										
07.35	<i>Drive configuration</i>	Plug 'n' play configuration. Performs HW initialization, and shows the detected module configuration of the drive. During the HW initialization, if the drive is not able to detect any module, the value is set to 1, Base unit. For information on automatic setting of parameters after detecting a module, see section <i>Automatic drive configuration for fieldbus control</i> on page 266.	0000h																																										
<table border="1"> <thead> <tr> <th>Bit</th> <th>Name</th> <th>Description</th> </tr> </thead> <tbody> <tr> <td>0</td> <td>Not initialized</td> <td>1 = Drive configuration has not been initialized</td> </tr> <tr> <td>1</td> <td>Base unit</td> <td>1 = Drive has not detected any modules.</td> </tr> <tr> <td>2</td> <td>Reserved</td> <td></td> </tr> <tr> <td>3</td> <td>FENA-21</td> <td>1 = FENA-21 Two-port Ethernet adapter module included</td> </tr> <tr> <td>4</td> <td>Reserved</td> <td></td> </tr> <tr> <td>5</td> <td>FPBA-01</td> <td>1 = FPBA-01 PROFIBUS DP adapter module included</td> </tr> <tr> <td>6</td> <td>FCAN-01</td> <td>1 = FCAN-01 CANopen adapter module included</td> </tr> <tr> <td>7...9</td> <td>Reserved</td> <td></td> </tr> <tr> <td>10</td> <td>FSCA-01</td> <td>1 = FSCA-01 Modbus/RTU adapter module included</td> </tr> <tr> <td>11</td> <td>FEIP-21</td> <td>1 = FEIP-21 Two-port EtherNet/IP adapter module included</td> </tr> <tr> <td>12</td> <td>FMBT-21</td> <td>1 = FMBT-21 Two-port Modbus/TCP adapter module included</td> </tr> <tr> <td>13</td> <td>Reserved</td> <td></td> </tr> <tr> <td>14</td> <td>FBNO-21</td> <td>1 = FPNO-21 Two-port PROFINET IO adapter module included</td> </tr> </tbody> </table>				Bit	Name	Description	0	Not initialized	1 = Drive configuration has not been initialized	1	Base unit	1 = Drive has not detected any modules.	2	Reserved		3	FENA-21	1 = FENA-21 Two-port Ethernet adapter module included	4	Reserved		5	FPBA-01	1 = FPBA-01 PROFIBUS DP adapter module included	6	FCAN-01	1 = FCAN-01 CANopen adapter module included	7...9	Reserved		10	FSCA-01	1 = FSCA-01 Modbus/RTU adapter module included	11	FEIP-21	1 = FEIP-21 Two-port EtherNet/IP adapter module included	12	FMBT-21	1 = FMBT-21 Two-port Modbus/TCP adapter module included	13	Reserved		14	FBNO-21	1 = FPNO-21 Two-port PROFINET IO adapter module included
Bit	Name	Description																																											
0	Not initialized	1 = Drive configuration has not been initialized																																											
1	Base unit	1 = Drive has not detected any modules.																																											
2	Reserved																																												
3	FENA-21	1 = FENA-21 Two-port Ethernet adapter module included																																											
4	Reserved																																												
5	FPBA-01	1 = FPBA-01 PROFIBUS DP adapter module included																																											
6	FCAN-01	1 = FCAN-01 CANopen adapter module included																																											
7...9	Reserved																																												
10	FSCA-01	1 = FSCA-01 Modbus/RTU adapter module included																																											
11	FEIP-21	1 = FEIP-21 Two-port EtherNet/IP adapter module included																																											
12	FMBT-21	1 = FMBT-21 Two-port Modbus/TCP adapter module included																																											
13	Reserved																																												
14	FBNO-21	1 = FPNO-21 Two-port PROFINET IO adapter module included																																											
	0000h...FFFFh	Drive configuration.	1 = 1																																										

No.	Name/Value	Description	Def/FbEq16																											
07.36	Drive configuration 2	Shows the detected module configuration. See parameter 07.35 Drive configuration .	0000h																											
<table border="1"> <thead> <tr> <th>Bit</th> <th>Name</th> <th>Description</th> </tr> </thead> <tbody> <tr> <td>0</td> <td>Reserved</td> <td></td> </tr> <tr> <td>1</td> <td>FDNA-01</td> <td>1 = FDNA-01 DeviceNet™ adapter module include</td> </tr> <tr> <td>2</td> <td>Reserved</td> <td></td> </tr> <tr> <td>3</td> <td>CMOD-01</td> <td>1 = CMOD-01 External 24 V AC/DC and digital I/O extension module included</td> </tr> <tr> <td>4</td> <td>CMOD-02</td> <td>1 = CMOD-02 External 24 V AC/DC and isolated PTC interface extension module included</td> </tr> <tr> <td>5</td> <td>CPTC-02</td> <td>1 = CPTC-02 ATEX certified PTC interface and external 24 V extension module included</td> </tr> <tr> <td>6</td> <td>CHDI-01</td> <td>1 = CHDI-01 115/230 V digital input extension module included</td> </tr> <tr> <td>7...15</td> <td>Reserved</td> <td></td> </tr> </tbody> </table>				Bit	Name	Description	0	Reserved		1	FDNA-01	1 = FDNA-01 DeviceNet™ adapter module include	2	Reserved		3	CMOD-01	1 = CMOD-01 External 24 V AC/DC and digital I/O extension module included	4	CMOD-02	1 = CMOD-02 External 24 V AC/DC and isolated PTC interface extension module included	5	CPTC-02	1 = CPTC-02 ATEX certified PTC interface and external 24 V extension module included	6	CHDI-01	1 = CHDI-01 115/230 V digital input extension module included	7...15	Reserved	
Bit	Name	Description																												
0	Reserved																													
1	FDNA-01	1 = FDNA-01 DeviceNet™ adapter module include																												
2	Reserved																													
3	CMOD-01	1 = CMOD-01 External 24 V AC/DC and digital I/O extension module included																												
4	CMOD-02	1 = CMOD-02 External 24 V AC/DC and isolated PTC interface extension module included																												
5	CPTC-02	1 = CPTC-02 ATEX certified PTC interface and external 24 V extension module included																												
6	CHDI-01	1 = CHDI-01 115/230 V digital input extension module included																												
7...15	Reserved																													
0000h...FFFFh		Drive configuration.	1 = 1																											
07.106	LSU loading package name	(Only visible for ACQ580-31 and ACQ580-34). Name of the loading package of the supply unit firmware.	-																											
07.107	LSU loading package version	(Only visible for ACQ580-31 and ACQ580-34). Version number of the loading package of the supply unit firmware.	-																											
10 Standard DI, RO																														
Configuration of digital inputs and relay outputs.																														
10.01	DI status	Displays the electrical status of digital inputs DI1...DI6. The activation/deactivation delays of the inputs (if any are specified) are ignored. Bits 0...5 reflect the status of DI1...DI6. Example: 000000000010011b = DI5, DI2 and DI1 are on, DI3, DI4 and DI6 are off. This parameter is read-only.	-																											
<table border="1"> <thead> <tr> <th>Bit</th> <th>Name</th> <th>Description</th> </tr> </thead> <tbody> <tr> <td>0</td> <td>DI1</td> <td>1 = Digital input 1 is ON.</td> </tr> <tr> <td>1</td> <td>DI2</td> <td>1 = Digital input 2 is ON.</td> </tr> <tr> <td>2</td> <td>DI3</td> <td>1 = Digital input 3 is ON.</td> </tr> <tr> <td>3</td> <td>DI4</td> <td>1 = Digital input 4 is ON.</td> </tr> <tr> <td>4</td> <td>DI5</td> <td>1 = Digital input 5 is ON.</td> </tr> <tr> <td>5</td> <td>DI6</td> <td>1 = Digital input 6 is ON.</td> </tr> <tr> <td>6...15</td> <td>Reserved</td> <td></td> </tr> </tbody> </table>				Bit	Name	Description	0	DI1	1 = Digital input 1 is ON.	1	DI2	1 = Digital input 2 is ON.	2	DI3	1 = Digital input 3 is ON.	3	DI4	1 = Digital input 4 is ON.	4	DI5	1 = Digital input 5 is ON.	5	DI6	1 = Digital input 6 is ON.	6...15	Reserved				
Bit	Name	Description																												
0	DI1	1 = Digital input 1 is ON.																												
1	DI2	1 = Digital input 2 is ON.																												
2	DI3	1 = Digital input 3 is ON.																												
3	DI4	1 = Digital input 4 is ON.																												
4	DI5	1 = Digital input 5 is ON.																												
5	DI6	1 = Digital input 6 is ON.																												
6...15	Reserved																													
0000h...FFFFh		Status of digital inputs.	1 = 1																											

No.	Name/Value	Description	Def/FbEq16																								
10.02	<i>DI delayed status</i>	Displays the <u>delayed</u> status of digital inputs DI1...DI6. Bits 0...5 reflect the delayed status of DI1...DI6. Example: 0000000000010011b = DI5, DI2 and DI1 are on, DI3, DI4 and DI6 are off. This word is updated only after a 2 ms activation/deactivation delay. When the value of a digital input changes, it must remain the same in two consecutive samples, that is for 2 ms, for the new value to be accepted. This parameter is read-only.	-																								
	0000h...FFFFh	Delayed status for digital inputs.	1 = 1																								
10.03	<i>DI force selection</i>	The electrical statuses of the digital inputs can be overridden, for example, testing purposes. A bit in parameter <i>10.04 DI forced data</i> is provided for each digital input, and its value is applied whenever the corresponding bit in this parameter is 1. Note: Boot and power cycle reset the force selections (parameters <i>10.03</i> and <i>10.04</i>).	0000h																								
<table border="1"> <thead> <tr> <th>Bit</th> <th>Name</th> <th>Value</th> </tr> </thead> <tbody> <tr> <td>0</td> <td>DI1</td> <td>1 = Force DI1 to value of bit 0 of parameter <i>10.04 DI forced data</i>. (0 = Normal mode)</td> </tr> <tr> <td>1</td> <td>DI2</td> <td>1 = Force DI2 to value of bit 1 of parameter <i>10.04 DI forced data</i>. (0 = Normal mode)</td> </tr> <tr> <td>2</td> <td>DI3</td> <td>1 = Force DI3 to value of bit 2 of parameter <i>10.04 DI forced data</i>. (0 = Normal mode)</td> </tr> <tr> <td>3</td> <td>DI4</td> <td>1 = Force DI4 to value of bit 3 of parameter <i>10.04 DI forced data</i>. (0 = Normal mode)</td> </tr> <tr> <td>4</td> <td>DI5</td> <td>1 = Force DI5 to value of bit 4 of parameter <i>10.04 DI forced data</i>. (0 = Normal mode)</td> </tr> <tr> <td>5</td> <td>DI6</td> <td>1 = Force DI6 to value of bit 5 of parameter <i>10.04 DI forced data</i>. (0 = Normal mode)</td> </tr> <tr> <td>6...15</td> <td>Reserved</td> <td></td> </tr> </tbody> </table>				Bit	Name	Value	0	DI1	1 = Force DI1 to value of bit 0 of parameter <i>10.04 DI forced data</i> . (0 = Normal mode)	1	DI2	1 = Force DI2 to value of bit 1 of parameter <i>10.04 DI forced data</i> . (0 = Normal mode)	2	DI3	1 = Force DI3 to value of bit 2 of parameter <i>10.04 DI forced data</i> . (0 = Normal mode)	3	DI4	1 = Force DI4 to value of bit 3 of parameter <i>10.04 DI forced data</i> . (0 = Normal mode)	4	DI5	1 = Force DI5 to value of bit 4 of parameter <i>10.04 DI forced data</i> . (0 = Normal mode)	5	DI6	1 = Force DI6 to value of bit 5 of parameter <i>10.04 DI forced data</i> . (0 = Normal mode)	6...15	Reserved	
Bit	Name	Value																									
0	DI1	1 = Force DI1 to value of bit 0 of parameter <i>10.04 DI forced data</i> . (0 = Normal mode)																									
1	DI2	1 = Force DI2 to value of bit 1 of parameter <i>10.04 DI forced data</i> . (0 = Normal mode)																									
2	DI3	1 = Force DI3 to value of bit 2 of parameter <i>10.04 DI forced data</i> . (0 = Normal mode)																									
3	DI4	1 = Force DI4 to value of bit 3 of parameter <i>10.04 DI forced data</i> . (0 = Normal mode)																									
4	DI5	1 = Force DI5 to value of bit 4 of parameter <i>10.04 DI forced data</i> . (0 = Normal mode)																									
5	DI6	1 = Force DI6 to value of bit 5 of parameter <i>10.04 DI forced data</i> . (0 = Normal mode)																									
6...15	Reserved																										
	0000h...FFFFh	Override selection for digital inputs.	1 = 1																								

No.	Name/Value	Description	Def/FbEq16																								
10.04	<i>DI forced data</i>	Allows the data value of a forced digital input to be changed from 0 to 1. It is only possible to force an input that has been selected in parameter 10.03 DI force selection . Bit 0 is the forced value for DI1; bit 5 is the forced value for the DI6.	0000h																								
<table border="1"> <thead> <tr> <th>Bit</th> <th>Name</th> <th>Value</th> </tr> </thead> <tbody> <tr> <td>0</td> <td>DI1</td> <td>1 = Force the value of this bit to D1, if so defined in parameter 10.03 DI force selection.</td> </tr> <tr> <td>1</td> <td>DI2</td> <td>1 = Force the value of this bit to D3, if so defined in parameter 10.03 DI force selection.</td> </tr> <tr> <td>2</td> <td>DI3</td> <td>1 = Force the value of this bit to D3, if so defined in parameter 10.03 DI force selection.</td> </tr> <tr> <td>3</td> <td>DI4</td> <td>1 = Force the value of this bit to D4, if so defined in parameter 10.03 DI force selection.</td> </tr> <tr> <td>4</td> <td>DI5</td> <td>1 = Force the value of this bit to D5, if so defined in parameter 10.03 DI force selection.</td> </tr> <tr> <td>5</td> <td>DI6</td> <td>1 = Force the value of this bit to D6, if so defined in parameter 10.03 DI force selection.</td> </tr> <tr> <td>6...15</td> <td>Reserved</td> <td></td> </tr> </tbody> </table>				Bit	Name	Value	0	DI1	1 = Force the value of this bit to D1, if so defined in parameter 10.03 DI force selection .	1	DI2	1 = Force the value of this bit to D3, if so defined in parameter 10.03 DI force selection .	2	DI3	1 = Force the value of this bit to D3, if so defined in parameter 10.03 DI force selection .	3	DI4	1 = Force the value of this bit to D4, if so defined in parameter 10.03 DI force selection .	4	DI5	1 = Force the value of this bit to D5, if so defined in parameter 10.03 DI force selection .	5	DI6	1 = Force the value of this bit to D6, if so defined in parameter 10.03 DI force selection .	6...15	Reserved	
Bit	Name	Value																									
0	DI1	1 = Force the value of this bit to D1, if so defined in parameter 10.03 DI force selection .																									
1	DI2	1 = Force the value of this bit to D3, if so defined in parameter 10.03 DI force selection .																									
2	DI3	1 = Force the value of this bit to D3, if so defined in parameter 10.03 DI force selection .																									
3	DI4	1 = Force the value of this bit to D4, if so defined in parameter 10.03 DI force selection .																									
4	DI5	1 = Force the value of this bit to D5, if so defined in parameter 10.03 DI force selection .																									
5	DI6	1 = Force the value of this bit to D6, if so defined in parameter 10.03 DI force selection .																									
6...15	Reserved																										
	0000h...FFFFh	Forced values of digital inputs.	1 = 1																								
10.05	<i>DI1 ON delay</i>	Defines the activation delay for digital input DI1.	0.00 s																								
<p>$t_{On} = 10.05$ <i>DI1 ON delay</i> $t_{Off} = 10.06$ <i>DI1 OFF delay</i> *Electrical status of digital input. Indicated by 10.01 DI status. **Indicated by 10.02 DI delayed status.</p>																											
	0.00 ... 3000.00 s	Activation delay for DI1.	10 = 1 s																								
10.06	<i>DI1 OFF delay</i>	Defines the deactivation delay for digital input DI1. See parameter 10.05 DI1 ON delay .	0.00 s																								
	0.00 ... 3000.00 s	Deactivation delay for DI1.	10 = 1 s																								

No.	Name/Value	Description	Def/FbEq16
10.07	<i>DI2 ON delay</i>	Defines the activation delay for digital input DI2.	0.00 s
<p> $t_{On} = 10.07 \text{ DI2 ON delay}$ $t_{Off} = 10.08 \text{ DI2 OFF delay}$ *Electrical status of digital input. Indicated by <i>10.01 DI status</i>. **Indicated by <i>10.02 DI delayed status</i>. </p>			
	0.00 ... 3000.00 s	Activation delay for DI2.	10 = 1 s
10.08	<i>DI2 OFF delay</i>	Defines the deactivation delay for digital input DI2. See parameter <i>10.07 DI2 ON delay</i> .	0.00 s
	0.00 ... 3000.00 s	Deactivation delay for DI2.	10 = 1 s
10.09	<i>DI3 ON delay</i>	Defines the activation delay for digital input DI3.	0.00 s
<p> $t_{On} = 10.09 \text{ DI3 ON delay}$ $t_{Off} = 10.10 \text{ DI3 OFF delay}$ *Electrical status of digital input. Indicated by <i>10.01 DI status</i>. **Indicated by <i>10.02 DI delayed status</i>. </p>			
	0.00 ... 3000.00 s	Activation delay for DI3.	10 = 1 s
10.10	<i>DI3 OFF delay</i>	Defines the deactivation delay for digital input DI3. See parameter <i>10.09 DI3 ON delay</i> .	0.00 s
	0.00 ... 3000.00 s	Deactivation delay for DI3.	10 = 1 s

No.	Name/Value	Description	Def/FbEq16
10.11	<i>DI4 ON delay</i>	Defines the activation delay for digital input DI4.	0.00 s
<p> $t_{On} = 10.11$ <i>DI4 ON delay</i> $t_{Off} = 10.12$ <i>DI4 OFF delay</i> *Electrical status of digital input. Indicated by <i>10.01 DI status</i>. **Indicated by <i>10.02 DI delayed status</i>. </p>			
	0.00 ... 3000.00 s	Activation delay for DI4.	10 = 1 s
10.12	<i>DI4 OFF delay</i>	Defines the deactivation delay for digital input DI4. See parameter <i>10.11 DI4 ON delay</i> .	0.00 s
	0.00 ... 3000.00 s	Deactivation delay for DI4.	10 = 1 s
10.13	<i>DI5 ON delay</i>	Defines the activation delay for digital input DI5.	0.00 s
<p> $t_{On} = 10.13$ <i>DI5 ON delay</i> $t_{Off} = 10.14$ <i>DI5 OFF delay</i> *Electrical status of digital input. Indicated by <i>10.01 DI status</i>. **Indicated by <i>10.02 DI delayed status</i>. </p>			
	0.00 ... 3000.00 s	Activation delay for DI5.	10 = 1 s
10.14	<i>DI5 OFF delay</i>	Defines the deactivation delay for digital input DI5. See parameter <i>10.13 DI5 ON delay</i> .	0.00 s
	0.00 ... 3000.00 s	Deactivation delay for DI5.	10 = 1 s

No.	Name/Value	Description	Def/FbEq16										
10.15	<i>DI6 ON delay</i>	Defines the activation delay for digital input DI6.	0.00 s										
<p>$t_{on} = 10.15$ <i>DI6 ON delay</i> $t_{off} = 10.16$ <i>DI6 OFF delay</i> *Electrical status of digital input. Indicated by 10.01 DI status. **Indicated by 10.02 DI delayed status.</p>													
	0.00 ... 3000.00 s	Activation delay for DI6.	10 = 1 s										
10.16	<i>DI6 OFF delay</i>	Defines the deactivation delay for digital input DI6. See parameter 10.15 DI6 ON delay .	0.00 s										
	0.00 ... 3000.00 s	Deactivation delay for DI6.	10 = 1 s										
10.21	<i>RO status</i>	Status of relay outputs RO3...RO1.	-										
<table border="1"> <thead> <tr> <th>Bit</th> <th>Value</th> </tr> </thead> <tbody> <tr> <td>0</td> <td>1 = RO1 is energized.</td> </tr> <tr> <td>1</td> <td>1 = RO2 is energized.</td> </tr> <tr> <td>2</td> <td>1 = RO3 is energized.</td> </tr> <tr> <td>3...15</td> <td>Reserved</td> </tr> </tbody> </table>				Bit	Value	0	1 = RO1 is energized.	1	1 = RO2 is energized.	2	1 = RO3 is energized.	3...15	Reserved
Bit	Value												
0	1 = RO1 is energized.												
1	1 = RO2 is energized.												
2	1 = RO3 is energized.												
3...15	Reserved												
	0000h...FFFFh	Status of relay outputs.	1 = 1										
10.22	<i>RO force selection</i>	The signals connected to the relay outputs can be overridden for, for example, testing purposes. A bit in parameter 10.23 RO forced data is provided for each relay output, and its value is applied whenever the corresponding bit in this parameter is 1. Note: Boot and power cycle reset the force selections (parameters 10.22 and 10.23).	0000h										
<table border="1"> <thead> <tr> <th>Bit</th> <th>Value</th> </tr> </thead> <tbody> <tr> <td>0</td> <td>1 = Force RO1 to value of bit 0 of parameter 10.23 RO forced data. (0 = Normal mode)</td> </tr> <tr> <td>1</td> <td>1 = Force RO2 to value of bit 1 of parameter 10.23 RO forced data. (0 = Normal mode)</td> </tr> <tr> <td>2</td> <td>1 = Force RO3 to value of bit 2 of parameter 10.23 RO forced data. (0 = Normal mode)</td> </tr> <tr> <td>3...15</td> <td>Reserved</td> </tr> </tbody> </table>				Bit	Value	0	1 = Force RO1 to value of bit 0 of parameter 10.23 RO forced data . (0 = Normal mode)	1	1 = Force RO2 to value of bit 1 of parameter 10.23 RO forced data . (0 = Normal mode)	2	1 = Force RO3 to value of bit 2 of parameter 10.23 RO forced data . (0 = Normal mode)	3...15	Reserved
Bit	Value												
0	1 = Force RO1 to value of bit 0 of parameter 10.23 RO forced data . (0 = Normal mode)												
1	1 = Force RO2 to value of bit 1 of parameter 10.23 RO forced data . (0 = Normal mode)												
2	1 = Force RO3 to value of bit 2 of parameter 10.23 RO forced data . (0 = Normal mode)												
3...15	Reserved												
	0000h...FFFFh	Override selection for relay outputs.	1 = 1										

No.	Name/Value	Description	Def/FbEq16										
10.23	<i>RO forced data</i>	Contains the values of relay outputs that are used instead of the connected signals if selected in parameter 10.22 RO force selection . Bit 0 is the forced value for RO1.	0000h										
<table border="1"> <thead> <tr> <th>Bit</th> <th>Value</th> </tr> </thead> <tbody> <tr> <td>0</td> <td>1 = Force the value of this bit to RO1, if so defined in parameter 10.22 RO force selection.</td> </tr> <tr> <td>1</td> <td>1 = Force the value of this bit to RO2, if so defined in parameter 10.22 RO force selection.</td> </tr> <tr> <td>2</td> <td>1 = Force the value of this bit to RO3, if so defined in parameter 10.22 RO force selection.</td> </tr> <tr> <td>3...15</td> <td>Reserved</td> </tr> </tbody> </table>				Bit	Value	0	1 = Force the value of this bit to RO1, if so defined in parameter 10.22 RO force selection .	1	1 = Force the value of this bit to RO2, if so defined in parameter 10.22 RO force selection .	2	1 = Force the value of this bit to RO3, if so defined in parameter 10.22 RO force selection .	3...15	Reserved
Bit	Value												
0	1 = Force the value of this bit to RO1, if so defined in parameter 10.22 RO force selection .												
1	1 = Force the value of this bit to RO2, if so defined in parameter 10.22 RO force selection .												
2	1 = Force the value of this bit to RO3, if so defined in parameter 10.22 RO force selection .												
3...15	Reserved												
	0000h...FFFFh	Forced RO values.	1 = 1										
10.24	<i>RO1 source</i>	Selects a drive signal to be connected to relay output RO1.	<i>Ready run</i>										
	Not energized	Output is not energized.	0										
	Energized	Output is energized.	1										
	Ready run	Bit 1 of 06.11 Main status word (see page 299).	2										
	Enabled	Bit 0 of 06.16 Drive status word 1 (see page 300).	4										
	Started	Bit 5 of 06.16 Drive status word 1 (see page 300).	5										
	Magnetized	Bit 1 of 06.17 Drive status word 2 (see page 301).	6										
	Running	Bit 6 of 06.16 Drive status word 1 (see page 300).	7										
	Ready ref	Bit 2 of 06.11 Main status word (see page 299).	8										
	At setpoint	Bit 8 of 06.11 Main status word (see page 299).	9										
	Reverse	Bit 2 of 06.19 Speed control status word (see page 302).	10										
	Zero speed	Bit 0 of 06.19 Speed control status word (see page 302).	11										
	Above limit	Bit 10 of 06.17 Drive status word 2 (see page 301).	12										
	Warning	Bit 7 of 06.11 Main status word (see page 299).	13										
	Fault	Bit 3 of 06.11 Main status word (see page 299).	14										
	Fault (-1)	Inverted bit 3 of 06.11 Main status word (see page 299).	15										
	Fault/Warning	Bit 3 of 06.11 Main status word OR bit 7 of 06.11 Main status word (see page 299).	16										
	Overcurrent	Fault 2310 Overcurrent has occurred.	17										
	Overvoltage	Fault 3210 DC link overvoltage has occurred.	18										
	Drive temp	Fault 2381 IGBT overload , 4110 Control board temperature , 4210 IGBT overtemperature , 4290 Cooling , 42F1 IGBT temperature , 4310 Excess temperature or 4380 Excess temperature difference has occurred.	19										
	Undervoltage	Fault 3220 DC link undervoltage has occurred.	20										
	Motor temp	Fault 4981 External temperature 1 or 4982 External temperature 2 has occurred.	21										
	Reserved		22										
	Ext2 active	Bit 11 of 06.16 Drive status word 1 (see page 300).	23										
	Remote control	Bit 9 of 06.11 Main status word (see page 299).	24										
	Reserved		25...26										

No.	Name/Value	Description	Def/FbEq16
	Timed function 1	Bit 0 of 34.01 Timed functions status (see page 410).	27
	Timed function 2	Bit 1 of 34.01 Timed functions status (see page 410).	28
	Timed function 3	Bit 2 of 34.01 Timed functions status (see page 410).	29
	Reserved		30...32
	Supervision 1	Bit 0 of 32.01 Supervision status (see page 403).	33
	Supervision 2	Bit 1 of 32.01 Supervision status (see page 403).	34
	Supervision 3	Bit 2 of 32.01 Supervision status (see page 403).	35
	Reserved		36...38
	Start delay	Bit 13 of 06.17 Drive status word 2 (see page 301).	39
	RO/DIO control word bit0	Bit 0 of 10.99 RO/DIO control word (see page 318).	40
	RO/DIO control word bit1	Bit 1 of 10.99 RO/DIO control word (see page 318).	41
	RO/DIO control word bit2	Bit 2 of 10.99 RO/DIO control word (see page 318).	42
	Reserved		43...44
	PFC1	Bit 0 of 76.01 PFC status (see page 484).	45
	PFC2	Bit 1 of 76.01 PFC status (see page 484).	46
	PFC3	Bit 2 of 76.01 PFC status (see page 484).	47
	PFC4	Bit 3 of 76.01 PFC status (see page 484).	48
	PFC5	Bit 4 of 76.01 PFC status (see page 484).	49
	PFC6	Bit 5 of 76.01 PFC status (see page 484).	50
	Reserved		51...52
	Event word 1	Event word 1 = 1 if any bit of 04.40 Event word 1 (see page 294) is 1, that is, if any warning, fault or pure event that has been defined with parameters 04.41...04.71 is on.	53
	Reserved		54
	Run permissive	Bit 7 of 06.22 Hand-off-auto status word .	55
	Start interlock 1	Bit 8 of 06.22 Hand-off-auto status word .	56
	Start interlock 2	Bit 9 of 06.22 Hand-off-auto status word .	57
	Start interlock 3	Bit 10 of 06.22 Hand-off-auto status word .	58
	Start interlock 4	Bit 11 of 06.22 Hand-off-auto status word .	59
	All start interlocks	Bit 12 of 06.22 Hand-off-auto status word .	60
	User load curve	Bit 3 (Outside load limit) of 37.01 ULC output status word (see page 433).	61
	RO/DIO control word	For 10.24 RO1 source : Bit 0 (RO1) of 10.99 RO/DIO control word (see page 318). For 10.27 RO2 source : Bit 1 (RO2) of 10.99 RO/DIO control word (see page 318). For 10.30 RO3 source : Bit 2 (RO3) of 10.99 RO/DIO control word (see page 318).	62
	<i>Other [bit]</i>	Source selection (see Terms and abbreviations on page 285).	-

No.	Name/Value	Description	Def/FbEq16
10.25	<i>RO1 ON delay</i>	Defines the activation delay for relay output RO1.	0.0 s
<p>$t_{On} = 10.25$ <i>RO1 ON delay</i> $t_{Off} = 10.26$ <i>RO1 OFF delay</i></p>			
	0.0 ... 3000.0 s	Activation delay for RO1.	10 = 1 s
10.26	<i>RO1 OFF delay</i>	Defines the deactivation delay for relay output RO1. See parameter 10.25 RO1 ON delay .	0.0 s
	0.0 ... 3000.0 s	Deactivation delay for RO1.	10 = 1 s
10.27	<i>RO2 source</i>	Selects a drive signal to be connected to relay output RO2. For the available selections, see parameter 10.24 RO1 source .	<i>Running</i>
10.28	<i>RO2 ON delay</i>	Defines the activation delay for relay output RO2.	0.0 s
<p>$t_{On} = 10.28$ <i>RO2 ON delay</i> $t_{Off} = 10.29$ <i>RO2 OFF delay</i></p>			
	0.0 ... 3000.0 s	Activation delay for RO2.	10 = 1 s
10.29	<i>RO2 OFF delay</i>	Defines the deactivation delay for relay output RO2. See parameter 10.28 RO2 ON delay .	0.0 s
	0.0 ... 3000.0 s	Deactivation delay for RO2.	10 = 1 s
10.30	<i>RO3 source</i>	Selects a drive signal to be connected to relay output RO3. For the available selections, see parameter 10.24 RO1 source .	<i>Fault (-1)</i>

No.	Name/Value	Description	Def/FbEq16
10.31	<i>RO3 ON delay</i>	Defines the activation delay for relay output RO3.	0.0 s
<p> $t_{On} = 10.31$ RO3 ON delay $t_{Off} = 10.32$ RO3 OFF delay </p>			
	0.0 ... 3000.0 s	Activation delay for RO3.	10 = 1 s
10.32	<i>RO3 OFF delay</i>	Defines the deactivation delay for relay output RO3. See parameter 10.31 RO3 ON delay .	0.0 s
	0.0 ... 3000.0 s	Deactivation delay for RO3.	10 = 1 s
10.99	<i>RO/DIO control word</i>	Storage parameter for controlling the relay outputs, for example, through the embedded fieldbus interface. To control the relay outputs (RO) of the drive, send a control word with the bit assignments shown below as Modbus I/O data. Set the target selection parameter of that particular data (58.101...58.114) to <i>RO/DIO control word</i> . In the source selection parameter of the desired output, select the appropriate bit of this word.	0000h
Bit	Name	Description	
0	RO1	Source bit for relay output RO1. See parameter 10.24 .	
1	RO2	Source bit for relay output RO2. See parameter 10.27 .	
2	RO3	Source bit for relay output RO3. See parameter 10.30 .	
3	RO4	Source bit for extension module relay output RO4. See parameter 15.07 .	
4	RO5	Source bit for extension module relay output RO4. See parameter 15.10 .	
5	RO6	Source bit for extension module relay output RO4. See parameter 15.13 .	
6	RO7	Source bit for extension module relay output RO4. See parameter 15.16 .	
7	Reserved		
8	DIO1	Source bit for digital output DO1 with a CMOD-01 extension module. See parameter 15.23 .	
9...15	Reserved		
	0000h...FFFFh	RO/DIO control word.	1 = 1
10.101	<i>RO1 toggle counter</i>	Displays the number of times relay output RO1 has changed states. Can be reset from the control panel by pressing the Reset softkey for 3 seconds.	5
	0...4294967000	State change count.	1 = 1

No.	Name/Value	Description	Def/FbEq16
10.102	<i>RO2 toggle counter</i>	Displays the number of times relay output RO2 has changed states. Can be reset from the control panel by pressing the Reset softkey for 3 seconds.	0
	0...4294967000	State change count.	1 = 1
10.103	<i>RO3 toggle counter</i>	Displays the number of times relay output RO3 has changed states. Can be reset from the control panel by pressing the Reset softkey for 3 seconds.	5
	0...4294967000	State change count.	1 = 1
11 Standard DIO, FI, FO			
11.21	<i>DI5 configuration</i>	Selects how digital input 5 is used.	<i>Digital input</i>
	Digital input	DI5 is used as a digital input.	0
	Frequency input	DI5 is used as a frequency input.	1
11.38	<i>Freq in 1 actual value</i>	Displays the value of frequency input 1 (via DI5 when it is used as a frequency input) before scaling. See parameter 11.42 Freq in 1 min . This parameter is read-only.	-
	0 ... 16000 Hz	Unscaled value of frequency input 1 (DI5).	1 = 1 Hz
11.39	<i>Freq in 1 scaled value</i>	Displays the value of frequency input 1 (via DI5 when it is used as a frequency input) after scaling. See parameter 11.42 Freq in 1 min . This parameter is read-only.	-
	-32768.000... 32767.000	Scaled value of frequency input 1 (DI5).	1 = 1
11.42	<i>Freq in 1 min</i>	Defines the minimum for the frequency actually arriving at frequency input 1 (DI5) when it is used as a frequency input). The incoming frequency signal (11.38 Freq in 1 actual value) is scaled into an internal signal (11.39 Freq in 1 scaled value) by parameters 11.42...11.45 as follows: 	0 Hz
	0 ... 16000 Hz	Minimum frequency of frequency input 1 (DI5).	1 = 1 Hz

No.	Name/Value	Description	Def/FbEq16
11.43	<i>Freq in 1 max</i>	Defines the maximum for the frequency actually arriving at frequency input 1 (DI5) when it is used as a frequency input). See parameter 11.42 Freq in 1 min .	16000 Hz
	0 ... 16000 Hz	Maximum frequency for frequency input 1 (DI5).	1 = 1 Hz
11.44	<i>Freq in 1 at scaled min</i>	Defines the value that is required to correspond internally to the minimum input frequency defined by parameter 11.42 Freq in 1 min . See diagram at parameter 11.42 Freq in 1 min .	0.000
	-32768.000... 32767.000	Value corresponding to minimum of frequency input 1.	1 = 1
11.45	<i>Freq in 1 at scaled max</i>	Defines the value that is required to correspond internally to the maximum input frequency defined by parameter 11.43 Freq in 1 max . See diagram at parameter 11.42 Freq in 1 min .	1500.000; 1800.000 (95.20 b0)
	-32768.000... 32767.000	Value corresponding to maximum of frequency input 1.	1 = 1

12 Standard AI		Configuration of standard analog inputs.												
12.02	<i>AI force selection</i>	<p>The true readings of the analog inputs can be overridden, for example, for testing purposes. A forced value parameter is provided for each analog input, and its value is applied whenever the corresponding bit in this parameter is 1.</p> <p>Notes:</p> <ul style="list-style-type: none"> AI filter times (parameters 12.16 AI1 filter time and 12.26 AI2 filter time) have no effect on forced AI values (parameters 12.13 AI1 forced value and 12.23 AI2 forced value). Boot and power cycle reset the force selections (parameters 12.02 and 12.03). 	0000h											
<table border="1"> <thead> <tr> <th>Bit</th> <th>Name</th> <th>Value</th> </tr> </thead> <tbody> <tr> <td>0</td> <td>AI1</td> <td>1 = Force AI1 to value of parameter 12.13 AI1 forced value.</td> </tr> <tr> <td>1</td> <td>AI2</td> <td>1 = Force AI2 to value of parameter 12.23 AI2 forced value.</td> </tr> <tr> <td>2...15</td> <td colspan="2">Reserved</td> </tr> </tbody> </table>		Bit	Name	Value	0	AI1	1 = Force AI1 to value of parameter 12.13 AI1 forced value .	1	AI2	1 = Force AI2 to value of parameter 12.23 AI2 forced value .	2...15	Reserved		
Bit	Name	Value												
0	AI1	1 = Force AI1 to value of parameter 12.13 AI1 forced value .												
1	AI2	1 = Force AI2 to value of parameter 12.23 AI2 forced value .												
2...15	Reserved													

	0000h...FFFFh	Forced values selector for analog inputs AI1 and AI2.	1 = 1
12.03	<i>AI supervision function</i>	<p>Selects how the drive reacts when an analog input signal moves out of the minimum and/or maximum limits specified for the input.</p> <p>The supervision applies a margin of 0.5 V or 1.0 mA to the limits. For example, if the maximum limit for the input is 7.000 V, the maximum limit supervision activates at 7.500 V. The inputs and the limits to be observed are selected by parameter 12.04 AI supervision selection.</p>	<i>No action</i>
	No action	No action taken.	0
	Fault	Drive trips on fault 80A0 AI supervision .	1
	Warning	Drive generates warning A8A0 AI supervision .	2
	Last speed	<p>Drive generates warning A8A0 AI supervision and freezes the speed (or frequency) to the level the drive was operating at. The speed/frequency is determined on the basis of actual speed using 850 ms low-pass filtering.</p> <p> WARNING! Make sure that it is safe to continue operation in case of a communication break.</p>	3

No.	Name/Value	Description	Def/FbEq16																		
	Speed ref safe	Drive generates warning <i>A8A0 AI supervision</i> and sets the speed to the speed defined by parameter <i>22.41 Speed ref safe</i> (or <i>28.41 Frequency ref safe</i> when frequency reference is being used).  WARNING! Make sure that it is safe to continue operation in case of a communication break.	4																		
12.04	<i>AI supervision selection</i>	Specifies the analog input limits to be supervised. See parameter <i>12.03 AI supervision function</i> .	0000h																		
		<table border="1"> <thead> <tr> <th>Bit</th> <th>Name</th> <th>Description</th> </tr> </thead> <tbody> <tr> <td>0</td> <td>AI1 < MIN</td> <td>1 = Minimum limit supervision of AI1 active.</td> </tr> <tr> <td>1</td> <td>AI1 > MAX</td> <td>1 = Maximum limit supervision of AI1 active.</td> </tr> <tr> <td>2</td> <td>AI2 < MIN</td> <td>1 = Minimum limit supervision of AI2 active.</td> </tr> <tr> <td>3</td> <td>AI2 > MAX</td> <td>1 = Maximum limit supervision of AI2 active.</td> </tr> <tr> <td>4...15</td> <td>Reserved</td> <td></td> </tr> </tbody> </table>	Bit	Name	Description	0	AI1 < MIN	1 = Minimum limit supervision of AI1 active.	1	AI1 > MAX	1 = Maximum limit supervision of AI1 active.	2	AI2 < MIN	1 = Minimum limit supervision of AI2 active.	3	AI2 > MAX	1 = Maximum limit supervision of AI2 active.	4...15	Reserved		
Bit	Name	Description																			
0	AI1 < MIN	1 = Minimum limit supervision of AI1 active.																			
1	AI1 > MAX	1 = Maximum limit supervision of AI1 active.																			
2	AI2 < MIN	1 = Minimum limit supervision of AI2 active.																			
3	AI2 > MAX	1 = Maximum limit supervision of AI2 active.																			
4...15	Reserved																				
	0000h...FFFFh	Activation of analog input supervision.	1 = 1																		
12.11	<i>AI1 actual value</i>	Displays the value of analog input AI1 in mA or V (depending on whether the input is set to current or voltage by a hardware setting). This parameter is read-only.	-																		
	0.000...22.000 mA or 0.000...11.000 V	Value of analog input AI1.	1000 = 1 unit																		
12.12	<i>AI1 scaled value</i>	Displays the value of analog input AI1 after scaling. See parameters <i>12.19 AI1 scaled at AI1 min</i> and <i>12.20 AI1 scaled at AI1 max</i> . This parameter is read-only.	-																		
	-32768.000... 32767.000	Scaled value of analog input AI1.	1 = 1																		
12.13	<i>AI1 forced value</i>	Forced value that can be used instead of the true reading of the input. See parameter <i>12.02 AI force selection</i> .	0.000 V																		
	0.000...22.000 mA or 0.000...11.000 V	Forced value of analog input AI1.	1000 = 1 unit																		
12.15	<i>AI1 unit selection</i>	Selects the unit for readings and settings related to analog input AI1.	V																		
	V	Volts.	2																		
	mA	Milliamperes.	10																		

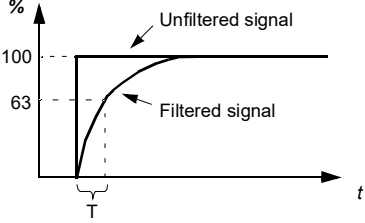
No.	Name/Value	Description	Def/FbEq16
12.16	<i>AI1 filter time</i>	<p>Defines the filter time constant for analog input AI1.</p>  <p>$O = I \times (1 - e^{-t/T})$</p> <p>I = filter input (step) O = filter output t = time T = filter time constant</p> <p>Note: The signal is also filtered due to the signal interface hardware (approximately 0.25 ms time constant). This cannot be changed by any parameter.</p>	0.100 s
	0.000...30.000 s	Filter time constant.	1000 = 1 s
12.17	<i>AI1 min</i>	<p>Defines the minimum site value for analog input AI1. Set the value actually sent to the drive when the analog signal from plant is wound to its minimum setting. See also parameter 12.19 AI1 scaled at AI1 min.</p>	4.000 mA or 0.000 V
	0.000...22.000 mA or 0.000...11.000 V	Minimum value of AI1.	1000 = 1 unit
12.18	<i>AI1 max</i>	<p>Defines the maximum site value for analog input AI1. Set the value actually sent to the drive when the analog signal from plant is wound to its maximum setting. See also parameter 12.19 AI1 scaled at AI1 min.</p>	20.000 mA or 10.000 V
	0.000...22.000 mA or 0.000...11.000 V	Maximum value of AI1.	1000 = 1 unit

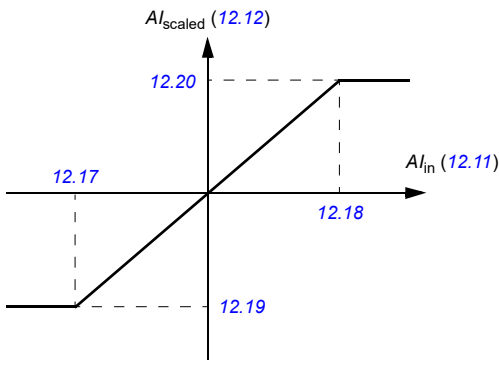
No.	Name/Value	Description	Def/FbEq16
12.19	<i>AI1 scaled at AI1 min</i>	Defines the real internal value that corresponds to the minimum analog input AI1 value defined by parameter 12.17 AI1 min . (Changing the polarity settings of 12.19 and 12.20 can effectively invert the analog input.) 	0.000
	-32768.000... 32767.000	Real value corresponding to minimum AI1 value.	1 = 1
12.20	<i>AI1 scaled at AI1 max</i>	Defines the real internal value that corresponds to the maximum analog input AI1 value defined by parameter 12.18 AI1 max . See the drawing at parameter 12.19 AI1 scaled at AI1 min .	50.000; 60.000 (95.20 b0)
	-32768.000... 32767.000	Real value corresponding to maximum AI1 value.	1 = 1
12.21	<i>AI2 actual value</i>	Displays the value of analog input AI2 in mA or V (depending on whether the input is set to current or voltage by a hardware setting). This parameter is read-only.	-
	0.000...22.000 mA or 0.000...11.000 V	Value of analog input AI2.	1000 = 1 unit
12.22	<i>AI2 scaled value</i>	Displays the value of analog input AI2 after scaling. See parameters 12.29 AI2 scaled at AI2 min and 12.101 AI1 percent value . This parameter is read-only.	-
	-32768.000... 32767.000	Scaled value of analog input AI2.	1 = 1
12.23	<i>AI2 forced value</i>	Forced value that can be used instead of the true reading of the input. See parameter 12.02 AI force selection .	0.000 V
	0.000...22.000 mA or 0.000...11.000 V	Forced value of analog input AI2.	1000 = 1 unit
12.25	<i>AI2 unit selection</i>	Selects the unit for readings and settings related to analog input AI2.	V
	V	Volts.	2
	mA	Milliamperes.	10
12.26	<i>AI2 filter time</i>	Defines the filter time constant for analog input AI2. See parameter 12.16 AI1 filter time .	0.100 s
	0.000...30.000 s	Filter time constant.	1000 = 1 s

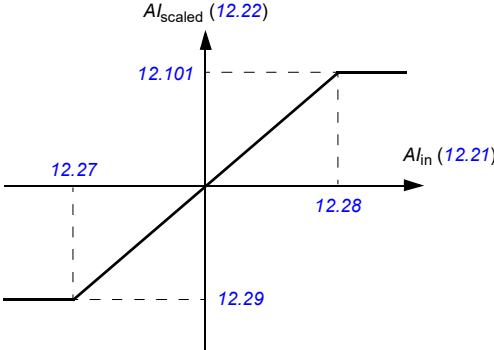
No.	Name/Value	Description	Def/FbEq16
12.27	<i>AI2 min</i>	Defines the minimum site value for analog input AI2. Set the value actually sent to the drive when the analog signal from plant is wound to its minimum setting.	0.000 V
	0.000...22.000 mA or 0.000...11.000 V	Minimum value of AI2.	1000 = 1 unit
12.28	<i>AI2 max</i>	Defines the maximum site value for analog input AI2. Set the value actually sent to the drive when the analog signal from plant is wound to its maximum setting.	10.000 V
	0.000...22.000 mA or 0.000...11.000 V	Maximum value of AI2.	1000 = 1 unit
12.29	<i>AI2 scaled at AI2 min</i>	Defines the real value that corresponds to the minimum analog input AI2 value defined by parameter <i>12.27 AI2 min</i> . (Changing the polarity settings of <i>12.29</i> and <i>12.101</i> can effectively invert the analog input.) 	0.000
	-32768.000... 32767.000	Real value corresponding to minimum AI2 value.	1 = 1
12.30	<i>AI2 scaled at AI2 max</i>	Defines the real value that corresponds to the <u>maximum</u> analog input AI2 value defined by parameter <i>12.28 AI2 max</i> . See the drawing at parameter of <i>12.29 AI2 scaled at AI2 min</i> .	50.000
	-32768.000... 32767.000	Real value corresponding to maximum AI2 value.	1 = 1
12.101	<i>AI1 percent value</i>	Value of analog input AI1 in percent of AI1 scaling (<i>12.18 AI1 max</i> - <i>12.17 AI1 min</i>).	-
	0.00...100.00%	AI1 value.	100 = 1%
12.102	<i>AI2 percent value</i>	Value of analog input AI2 in percent of AI2 scaling (<i>12.28 AI2 max</i> - <i>12.27 AI2 min</i>).	-
	0.00...100.00%	AI2 value.	100 = 1%

No.	Name/Value	Description	Def/FbEq16												
13 Standard AO		Configuration of standard analog outputs.													
13.02	<i>AO force selection</i>	The source signals of the analog outputs can be overridden, for example, for testing purposes. A forced value parameter is provided for each analog output, and its value is applied whenever the corresponding bit in this parameter is 1. Note: Boot and power cycle reset the force selections (parameters 13.02 and 13.11).	0000h												
<table border="1"> <thead> <tr> <th>Bit</th> <th>Name</th> <th>Value</th> </tr> </thead> <tbody> <tr> <td>0</td> <td>AO1</td> <td>1 = Force AO1 to value of parameter 13.13 AO1 forced value. (0 = Normal mode)</td> </tr> <tr> <td>1</td> <td>AO2</td> <td>1 = Force AO2 to value of parameter 13.23 AO2 forced value. (0 = Normal mode)</td> </tr> <tr> <td>2...15</td> <td>Reserved</td> <td></td> </tr> </tbody> </table>				Bit	Name	Value	0	AO1	1 = Force AO1 to value of parameter 13.13 AO1 forced value . (0 = Normal mode)	1	AO2	1 = Force AO2 to value of parameter 13.23 AO2 forced value . (0 = Normal mode)	2...15	Reserved	
Bit	Name	Value													
0	AO1	1 = Force AO1 to value of parameter 13.13 AO1 forced value . (0 = Normal mode)													
1	AO2	1 = Force AO2 to value of parameter 13.23 AO2 forced value . (0 = Normal mode)													
2...15	Reserved														
	0000h...FFFFh	Forced values selector for analog outputs AO1 and AO2.	1 = 1												
13.11	<i>AO1 actual value</i>	Displays the value of AO1 in mA or V. This parameter is read-only.	-												
	0.000...22.000 mA or 0.000...11.000 V	Value of AO1.	1000 = 1 unit												
13.12	<i>AO1 source</i>	Selects a signal to be connected to analog output AO1.	<i>Output frequency</i>												
	Zero	None.	0												
	Motor speed used	01.01 Motor speed used (page 288).	1												
	Reserved		2												
	Output frequency	01.06 Output frequency (page 288).	3												
	Motor current	01.07 Motor current (page 288).	4												
	Motor current % of motor nominal	01.08 Motor current % of motor nom (page 288).	5												
	Motor torque	01.10 Motor torque (page 288).	6												
	DC voltage	01.11 DC voltage (page 288).	7												
	Output power	01.14 Output power (page 289).	8												
	Reserved		9												
	Speed ref ramp in	23.01 Speed ref ramp input (page 370).	10												
	Speed ref ramp out	23.02 Speed ref ramp output (page 370).	11												
	Speed ref used	24.01 Used speed reference (page 371).	12												
	Reserved		13												
	Freq ref used	28.02 Frequency ref ramp output (page 377).	14												
	Reserved		15												
	Process PID out	40.01 Process PID output actual (page 437).	16												
	Reserved		17...19												
	Temp sensor 1 excitation	The output is used to feed an excitation current to the temperature sensor 1, see parameter 35.11 Temperature 1 source . See also section Programmable protection functions (page 178).	20												

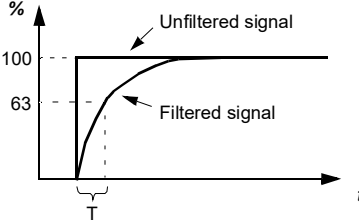
No.	Name/Value	Description	Def/FbEq16
	Temp sensor 2 excitation	The output is used to feed an excitation current to the temperature sensor 2, see parameter 35.21 Temperature 2 source . See also section Programmable protection functions (page 178).	21
	Reserved		21...25
	Abs motor speed used	01.61 Abs motor speed used (page 291).	26
	Abs motor speed %	01.62 Abs motor speed % (page 291).	27
	Abs output frequency	01.63 Abs output frequency (page 291).	28
	Reserved		29
	Abs motor torque	01.64 Abs motor torque (page 291).	30
	Abs output power	01.65 Abs output power (page 291).	31
	Abs motor shaft power	01.68 Abs motor shaft power (page 291).	32
	External PID1 out	71.01 External PID act value (page 482).	33
	Reserved		34...36
	AO1 data storage	13.91 AO1 data storage (page 331).	37
	AO2 data storage	13.92 AO2 data storage (page 331).	38
	<i>Other</i>	Source selection (see Terms and abbreviations on page 285).	-
13.13	AO1 forced value	Forced value that can be used instead of the selected output signal. See parameter 13.02 AO force selection .	0.000 V
	0.000...22.000 mA / 0.000...11.000 V	Forced value for AO1.	1000 = 1 unit
13.15	AO1 unit selection	Selects the unit for readings and settings related to analog input AO1.	V
	V	Volts.	2
	mA	Milliamperes.	10
13.16	AO1 filter time	Defines the filtering time constant for analog output AO1.  $O = I \times (1 - e^{-t/T})$ I = filter input (step) O = filter output t = time T = filter time constant	0.100 s
	0.000 ... 30.000 s	Filter time constant.	1000 = 1 s

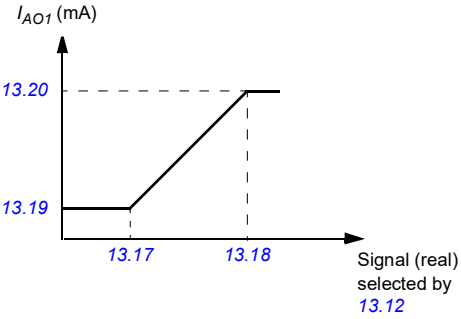
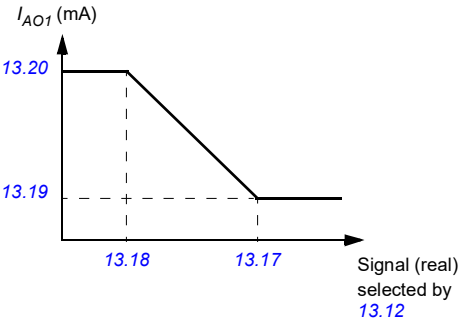
No.	Name/Value	Description	Def/FbEq16
13.17	<i>AO1 source min</i>	<p data-bbox="393 169 904 256">Defines the real minimum value of the signal (selected by parameter 13.12 AO1 source) that corresponds to the minimum required AO1 output value (defined by parameter 13.19 AO1 out at AO1 src min).</p> <div data-bbox="408 288 868 608">  <p data-bbox="408 288 868 608">The graph plots I_{AO1} (mA) on the vertical axis against the Signal (real) selected by 13.12 on the horizontal axis. The vertical axis has tick marks at 13.19 and 13.20. The horizontal axis has tick marks at 13.17 and 13.18. The signal curve is constant at 13.19 mA until the signal reaches 13.17. From 13.17 to 13.18, the signal increases linearly from 13.19 mA to 13.20 mA. For signal values greater than 13.18, the output current remains constant at 13.20 mA.</p> </div> <p data-bbox="393 639 904 679">Programming 13.17 as the maximum value and 13.18 as the minimum value inverts the output.</p> <div data-bbox="408 711 868 1031">  <p data-bbox="408 711 868 1031">The graph plots I_{AO1} (mA) on the vertical axis against the Signal (real) selected by 13.12 on the horizontal axis. The vertical axis has tick marks at 13.19 and 13.20. The horizontal axis has tick marks at 13.18 and 13.17. The signal curve is constant at 13.20 mA until the signal reaches 13.18. From 13.18 to 13.17, the signal decreases linearly from 13.20 mA to 13.19 mA. For signal values greater than 13.17, the output current remains constant at 13.19 mA.</p> </div>	0.0

No.	Name/Value	Description	Def/FbEq16
AO has automatic scaling. Every time the source for the AO is changed, the scaling range is changed accordingly. User given minimum and maximum values override the automatic values.			
	13.12 AO1 source , 13.22 AO2 source	13.17 AO1 source min , 13.27 AO2 source min	13.18 AO1 source max , 13.28 AO2 source max
0	Zero	N/A (Output is constant zero.)	
1	Motor speed used	0	46.01 Speed scaling
3	Output frequency	0	46.02 Frequency scaling
4	Motor current	0	Max. value of 30.17 Maximum current
5	Motor current % of motor nominal	0%	100%
6	Motor torque	0	46.03 Torque scaling
7	DC voltage	Min. value of 01.11 DC voltage	Max. value of 01.11 DC voltage
8	Output power	0	46.04 Power scaling
10	Speed ref ramp in	0	46.01 Speed scaling
11	Speed ref ramp out	0	46.01 Speed scaling
12	Speed ref used	0	46.01 Speed scaling
14	Freq ref used	0	46.02 Frequency scaling
16	Process PID out	Min. value of 40.01 Process PID output actual	Max. value of 40.01 Process PID output actual
20	Temp sensor 1 excitation	N/A (Analog output is not scaled; it is determined by the sensor's triggering voltage.)	
21	Temp sensor 2 excitation		
26	Abs motor speed used	0	46.01 Speed scaling
27	Abs motor speed %	0	46.01 Speed scaling
28	Abs output frequency	0	46.02 Frequency scaling
30	Abs motor torque	0	46.03 Torque scaling
31	Abs output power	0	46.04 Power scaling
32	Abs motor shaft power	0	46.04 Power scaling
33	External PID1 out	Min. value of 71.01 External PID act value	Max. value of 71.01 External PID act value
	<i>Other</i>	Min. value of the selected parameter	Max. value of the selected parameter
	-32768.0...32767.0	Real signal value corresponding to minimum AO1 output value.	1 = 1
13.18	AO1 source max	Defines the real maximum value of the signal (selected by parameter 13.12 AO1 source) that corresponds to the maximum required AO1 output value (defined by parameter 13.20 AO1 out at AO1 src max). See parameter 13.17 AO1 source min .	50.0; 60.0 (95.20 b0)
	-32768.0...32767.0	Real signal value corresponding to maximum AO1 output value.	1 = 1
13.19	AO1 out at AO1 src min	Defines the minimum output value for analog output AO1. See also drawing at parameter 13.17 AO1 source min .	0.000 V
	0.000...22.000 mA / 0.000...11.000 V	Minimum AO1 output value.	1000 = 1 unit

No.	Name/Value	Description	Def/FbEq16
13.20	<i>AO1 out at AO1 src max</i>	Defines the maximum output value for analog output AO1. See also drawing at parameter 13.17 AO1 source min.	10.000 V
	0.000...22.000 mA / 0.000...11.000 V	Maximum AO1 output value.	1000 = 1 unit
13.21	<i>AO2 actual value</i>	Displays the value of AO2 in mA. This parameter is read-only.	-
	0.000 ... 22.000 mA	Value of AO2.	1000 = 1 mA
13.22	<i>AO2 source</i>	Selects a signal to be connected to analog output AO2. Alternatively, sets the output to excitation mode to feed a constant current to a temperature sensor. For the selections, see parameter 13.12 AO1 source.	<i>Motor current</i>
13.23	<i>AO2 forced value</i>	Forced value that can be used instead of the selected output signal. See parameter 13.02 AO force selection.	0.000 mA
	0.000 ... 22.000 mA	Forced value for AO2.	1000 = 1 mA
13.26	<i>AO2 filter time</i>	Defines the filtering time constant for analog output AO2. See parameter 13.16 AO1 filter time.	0.100 s
	0.000 ... 30.000 s	Filter time constant.	1000 = 1 s

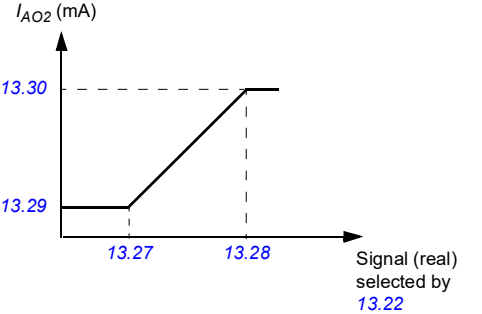
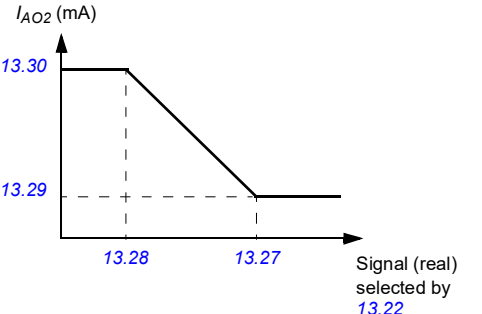
No.	Name/Value	Description	Def/FbEq16
13.27	<i>AO2 source min</i>	<p>Defines the real minimum value of the signal (selected by parameter 13.22 AO2 source) that corresponds to the minimum required AO2 output value (defined by parameter 13.29 AO2 out at AO2 src min). See parameter 13.17 AO1 source min about the AO automatic scaling.</p>  <p>Programming 13.27 as the maximum value and 13.28 as the minimum value inverts the output.</p> 	0.0
	-32768.0...32767.0	Real signal value corresponding to minimum AO2 output value.	1 = 1
13.28	<i>AO2 source max</i>	<p>Defines the real maximum value of the signal (selected by parameter 13.22 AO2 source) that corresponds to the maximum required AO2 output value (defined by parameter 13.30 AO2 out at AO2 src max). See parameter 13.27 AO2 source min. See parameter 13.17 AO1 source min about the AO automatic scaling.</p>	30000.0
	-32768.0...32767.0	Real signal value corresponding to maximum AO2 output value.	1 = 1
13.29	<i>AO2 out at AO2 src min</i>	Defines the minimum output value for analog output AO2. See also drawing at parameter 13.27 AO2 source min .	4.000 mA
	0.000 ... 22.000 mA	Minimum AO2 output value.	1000 = 1 mA

No.	Name/Value	Description	Def/FbEq16
13.30	<i>AO2 out at AO2 src max</i>	Defines the maximum output value for analog output AO2. See also drawing at parameter <i>13.27 AO2 source min</i> .	20.000 mA
	0.000 ... 22.000 mA	Maximum AO2 output value.	1000 = 1 mA
13.91	<i>AO1 data storage</i>	Storage parameter for controlling analog output AO1, for example, through the embedded fieldbus interface. In parameter <i>13.12 AO1 source</i> , select <i>AO1 data storage</i> . Then set this parameter as the target of the incoming value data. With the embedded fieldbus interface, simply set the target selection parameter of that particular data (<i>58.101...58.114</i>) to <i>AO1 data storage</i> .	0.00
	-327.68...327.67	Storage parameter for AO1.	100 = 1
13.92	<i>AO2 data storage</i>	Storage parameter for controlling analog output AO2, for example, through the embedded fieldbus interface. In parameter <i>13.22 AO2 source</i> , select <i>AO2 data storage</i> . Then set this parameter as the target of the incoming value data. With the embedded fieldbus interface, simply set the target selection parameter of that particular data (<i>58.101...58.114</i>) to <i>AO2 data storage</i> .	0.00
	-327.68...327.67	Storage parameter for AO2.	100 = 1

15 I/O extension module		Configuration of the I/O extension module installed in slot 2. See also section <i>Programmable I/O extensions</i> (page 96). Note: The contents of the parameter group vary according to the selected I/O extension module type.	
15.01	<i>Extension module type</i>	Activates (and specifies the type of) I/O extension module. If the value is <i>None</i> , when an extension module has been installed and the drive is powered, the drive automatically sets the value to the type it has detected (= value of parameter <i>15.02 Detected extension module</i>); otherwise warning <i>ATAB Extension I/O configuration failure</i> is generated and you have to set the value of this parameter manually.	<i>CMOD-01</i>
	None	Inactive.	0
	CMOD-01	CMOD-01 multifunction extension module (external 24 V AC/DC and digital I/O).	1
	CMOD-02	CMOD-02 multifunction extension module (external 24 V AC/DC and isolated PTC interface).	2
	CHDI-01	CHDI-01 115/230 V digital input extension module.	3
	CPTC-02	CPTC-02 extension module (external 24 V and ATEX certified PTC interface).	4
15.02	<i>Detected extension module</i>	I/O extension module detected on the drive.	<i>CMOD-01</i>
	None	Inactive.	0
	CMOD-01	CMOD-01 multifunction extension module (external 24 V AC/DC and digital I/O).	1
	CMOD-02	CMOD-02 multifunction extension module (external 24 V AC/DC and isolated PTC interface).	2
	CHDI-01	CHDI-01 115/230 V digital input extension module.	3
	CPTC-02	CPTC-02 extension module (external 24 V and ATEX certified PTC interface).	4

No.	Name/Value	Description	Def/FbEq16																								
15.03	<i>DI status</i>	Displays the status of the digital inputs DI7...DI12 on the extension module Bit 0 indicates the status of DI7. Example: 001001b = DI7 and DI10 are on, remainder are off. This parameter is read-only.	-																								
<table border="1"> <thead> <tr> <th>Bit</th> <th>Name</th> <th>Description</th> </tr> </thead> <tbody> <tr> <td>0</td> <td>DI7</td> <td>1 = Digital input 7 is ON.</td> </tr> <tr> <td>1</td> <td>DI8</td> <td>1 = Digital input 8 is ON.</td> </tr> <tr> <td>2</td> <td>DI9</td> <td>1 = Digital input 9 is ON.</td> </tr> <tr> <td>3</td> <td>DI10</td> <td>1 = Digital input 10 is ON.</td> </tr> <tr> <td>4</td> <td>DI11</td> <td>1 = Digital input 11 is ON.</td> </tr> <tr> <td>5</td> <td>DI12</td> <td>1 = Digital input 12 is ON.</td> </tr> <tr> <td>6...15</td> <td>Reserved</td> <td></td> </tr> </tbody> </table>				Bit	Name	Description	0	DI7	1 = Digital input 7 is ON.	1	DI8	1 = Digital input 8 is ON.	2	DI9	1 = Digital input 9 is ON.	3	DI10	1 = Digital input 10 is ON.	4	DI11	1 = Digital input 11 is ON.	5	DI12	1 = Digital input 12 is ON.	6...15	Reserved	
Bit	Name	Description																									
0	DI7	1 = Digital input 7 is ON.																									
1	DI8	1 = Digital input 8 is ON.																									
2	DI9	1 = Digital input 9 is ON.																									
3	DI10	1 = Digital input 10 is ON.																									
4	DI11	1 = Digital input 11 is ON.																									
5	DI12	1 = Digital input 12 is ON.																									
6...15	Reserved																										
	0000h...FFFFh	Status of digital input/outputs.	1 = 1																								
15.04	<i>RO/DO status</i>	Displays the status of the relay outputs RO4 and RO7 and digital output DO1 on the extension module. Bits 0...3 indicates the status of RO4...RO7; bit 5 indicates the status of DO1. Example: 100101b = RO4 and RO7 are on, RO5 and R6 are off and DO1 is on. This parameter is read-only.	-																								
<table border="1"> <thead> <tr> <th>Bit</th> <th>Name</th> <th>Description</th> </tr> </thead> <tbody> <tr> <td>0</td> <td>RO4</td> <td>1 = Relay output 4 is ON.</td> </tr> <tr> <td>1</td> <td>RO5</td> <td>1 = Relay output 5 is ON</td> </tr> <tr> <td>2</td> <td>RO6</td> <td>1 = Relay output 6 is ON</td> </tr> <tr> <td>3</td> <td>RO7</td> <td>1 = Relay output 7 is ON</td> </tr> <tr> <td>4</td> <td>Reserved</td> <td></td> </tr> <tr> <td>5</td> <td>DO1</td> <td>1 = Digital output 1 is ON.</td> </tr> <tr> <td>6...15</td> <td>Reserved</td> <td></td> </tr> </tbody> </table>				Bit	Name	Description	0	RO4	1 = Relay output 4 is ON.	1	RO5	1 = Relay output 5 is ON	2	RO6	1 = Relay output 6 is ON	3	RO7	1 = Relay output 7 is ON	4	Reserved		5	DO1	1 = Digital output 1 is ON.	6...15	Reserved	
Bit	Name	Description																									
0	RO4	1 = Relay output 4 is ON.																									
1	RO5	1 = Relay output 5 is ON																									
2	RO6	1 = Relay output 6 is ON																									
3	RO7	1 = Relay output 7 is ON																									
4	Reserved																										
5	DO1	1 = Digital output 1 is ON.																									
6...15	Reserved																										
	0000h...FFFFh	Status of relay/digital outputs.	1 = 1																								

No.	Name/Value	Description	Def/FbEq16																								
15.05	RO/DO force selection	The electrical statuses of the relay/digital outputs can be overridden, for example, for testing purposes. A bit in parameter 15.06 RO/DO forced data is provided for each relay or digital output, and its value is applied whenever the corresponding bit in this parameter is 1. Note: Boot and power cycle reset the force selections (parameters 15.05 and 15.06).	0000h																								
<table border="1"> <thead> <tr> <th>Bit</th> <th>Name</th> <th>Value</th> </tr> </thead> <tbody> <tr> <td>0</td> <td>RO4</td> <td>1 = Force RO4 to value of bit 0 of parameter 15.06 RO/DO forced data. (0 = Normal mode)</td> </tr> <tr> <td>1</td> <td>RO5</td> <td>1 = Force RO5 to value of bit 1 of parameter 15.06 RO/DO forced data. (0 = Normal mode)</td> </tr> <tr> <td>2</td> <td>RO6</td> <td>1 = Force RO6 to value of bit 2 of parameter 15.06 RO/DO forced data. (0 = Normal mode)</td> </tr> <tr> <td>3</td> <td>RO7</td> <td>1 = Force RO7 to value of bit 3 of parameter 15.06 RO/DO forced data. (0 = Normal mode)</td> </tr> <tr> <td>4</td> <td colspan="2">Reserved</td> </tr> <tr> <td>5</td> <td>DO1</td> <td>1 = Force DO1 to value of bit 5 of parameter 15.06 RO/DO forced data. (0 = Normal mode)</td> </tr> <tr> <td>6...15</td> <td colspan="2">Reserved</td> </tr> </tbody> </table>				Bit	Name	Value	0	RO4	1 = Force RO4 to value of bit 0 of parameter 15.06 RO/DO forced data . (0 = Normal mode)	1	RO5	1 = Force RO5 to value of bit 1 of parameter 15.06 RO/DO forced data . (0 = Normal mode)	2	RO6	1 = Force RO6 to value of bit 2 of parameter 15.06 RO/DO forced data . (0 = Normal mode)	3	RO7	1 = Force RO7 to value of bit 3 of parameter 15.06 RO/DO forced data . (0 = Normal mode)	4	Reserved		5	DO1	1 = Force DO1 to value of bit 5 of parameter 15.06 RO/DO forced data . (0 = Normal mode)	6...15	Reserved	
Bit	Name	Value																									
0	RO4	1 = Force RO4 to value of bit 0 of parameter 15.06 RO/DO forced data . (0 = Normal mode)																									
1	RO5	1 = Force RO5 to value of bit 1 of parameter 15.06 RO/DO forced data . (0 = Normal mode)																									
2	RO6	1 = Force RO6 to value of bit 2 of parameter 15.06 RO/DO forced data . (0 = Normal mode)																									
3	RO7	1 = Force RO7 to value of bit 3 of parameter 15.06 RO/DO forced data . (0 = Normal mode)																									
4	Reserved																										
5	DO1	1 = Force DO1 to value of bit 5 of parameter 15.06 RO/DO forced data . (0 = Normal mode)																									
6...15	Reserved																										
0000h...FFFFh			Override selection for relay/digital outputs.																								
15.06	RO/DO forced data	Allows the data value of a forced relay or digital output to be changed from 0 to 1. It is only possible to force an output that has been selected in parameter 15.05 RO/DO force selection . Bits 0...1 are the forced values for RO4...RO5; bit 5 is the forced value for DO1.	1 = 1 0000h																								
<table border="1"> <thead> <tr> <th>Bit</th> <th>Name</th> <th>Description</th> </tr> </thead> <tbody> <tr> <td>0</td> <td>RO4</td> <td>1 = Force the value of this bit to RO4, if so defined in parameter 15.05 RO/DO force selection.</td> </tr> <tr> <td>1</td> <td>RO5</td> <td>1 = Force the value of this bit to RO5, if so defined in parameter 15.05 RO/DO force selection.</td> </tr> <tr> <td>2</td> <td>RO6</td> <td>1 = Force the value of this bit to RO6, if so defined in parameter 15.05 RO/DO force selection.</td> </tr> <tr> <td>3</td> <td>RO7</td> <td>1 = Force the value of this bit to RO7, if so defined in parameter 15.05 RO/DO force selection.</td> </tr> <tr> <td>4</td> <td colspan="2">Reserved</td> </tr> <tr> <td>5</td> <td>DO1</td> <td>1 = Force the value of this bit to DO1 if so defined in parameter 15.05 RO/DO force selection.</td> </tr> <tr> <td>6...15</td> <td colspan="2">Reserved</td> </tr> </tbody> </table>				Bit	Name	Description	0	RO4	1 = Force the value of this bit to RO4, if so defined in parameter 15.05 RO/DO force selection .	1	RO5	1 = Force the value of this bit to RO5, if so defined in parameter 15.05 RO/DO force selection .	2	RO6	1 = Force the value of this bit to RO6, if so defined in parameter 15.05 RO/DO force selection .	3	RO7	1 = Force the value of this bit to RO7, if so defined in parameter 15.05 RO/DO force selection .	4	Reserved		5	DO1	1 = Force the value of this bit to DO1 if so defined in parameter 15.05 RO/DO force selection .	6...15	Reserved	
Bit	Name	Description																									
0	RO4	1 = Force the value of this bit to RO4, if so defined in parameter 15.05 RO/DO force selection .																									
1	RO5	1 = Force the value of this bit to RO5, if so defined in parameter 15.05 RO/DO force selection .																									
2	RO6	1 = Force the value of this bit to RO6, if so defined in parameter 15.05 RO/DO force selection .																									
3	RO7	1 = Force the value of this bit to RO7, if so defined in parameter 15.05 RO/DO force selection .																									
4	Reserved																										
5	DO1	1 = Force the value of this bit to DO1 if so defined in parameter 15.05 RO/DO force selection .																									
6...15	Reserved																										
0000h...FFFFh			Forced values of relay/digital outputs.																								
15.07	RO4 source	Selects a drive signal to be connected to relay output RO4.	Not energized																								
Not energized			Output is not energized.																								
Energized			Output is energized.																								
Ready run			Bit 1 of 06.11 Main status word (see page 299).																								
Reserved																											
			0																								
			1																								
			2																								
			3																								

No.	Name/Value	Description	Def/FbEq16
	Enabled	Bit 0 of <i>06.16 Drive status word 1</i> (see page 300).	4
	Started	Bit 5 of <i>06.16 Drive status word 1</i> (see page 300).	5
	Magnetized	Bit 1 of <i>06.17 Drive status word 2</i> (see page 301).	6
	Running	Bit 6 of <i>06.16 Drive status word 1</i> (see page 300).	7
	Ready ref	Bit 2 of <i>06.11 Main status word</i> (see page 299).	8
	At setpoint	Bit 8 of <i>06.11 Main status word</i> (see page 299).	9
	Reverse	Bit 2 of <i>06.19 Speed control status word</i> (see page 302).	10
	Zero speed	Bit 0 of <i>06.19 Speed control status word</i> (see page 302).	11
	Above limit	Bit 10 of <i>06.17 Drive status word 2</i> (see page 301).	12
	Warning	Bit 7 of <i>06.11 Main status word</i> (see page 299).	13
	Fault	Bit 3 of <i>06.11 Main status word</i> (see page 299).	14
	Fault (-1)	Inverted bit 3 of <i>06.11 Main status word</i> (see page 299).	15
	Fault/Warning	Bit 3 of <i>06.11 Main status word</i> OR bit 7 of <i>06.11 Main status word</i> (see page 299).	16
	Overcurrent	Fault <i>2310 Overcurrent</i> has occurred.	17
	Overvoltage	Fault <i>3210 DC link overvoltage</i> has occurred.	18
	Drive temp	Fault <i>2381 IGBT overload</i> , <i>4110 Control board temperature</i> , <i>4210 IGBT overtemperature</i> , <i>4290 Cooling</i> , <i>42F1 IGBT temperature</i> , <i>4310 Excess temperature</i> or <i>4380 Excess temperature difference</i> has occurred.	19
	Undervoltage	Fault <i>3220 DC link undervoltage</i> has occurred.	20
	Motor temp	Fault <i>4981 External temperature 1</i> or <i>4982 External temperature 2</i> has occurred.	21
	Reserved		22
	Ext2 active	Bit 11 of <i>06.16 Drive status word 1</i> (see page 300).	23
	Remote control	Bit 9 of <i>06.11 Main status word</i> (see page 299).	24
	Reserved		25...26
	Timed function 1	Bit 0 of <i>34.01 Timed functions status</i> (see page 410).	27
	Timed function 2	Bit 1 of <i>34.01 Timed functions status</i> (see page 410).	28
	Timed function 3	Bit 2 of <i>34.01 Timed functions status</i> (see page 410).	29
	Reserved		30...32
	Supervision 1	Bit 0 of <i>32.01 Supervision status</i> (see page 403).	33
	Supervision 2	Bit 1 of <i>32.01 Supervision status</i> (see page 403).	34
	Supervision 3	Bit 2 of <i>32.01 Supervision status</i> (see page 403).	35
	Reserved		36...38
	Start delay	Bit 13 of <i>06.17 Drive status word 2</i> (see page 301).	39
	RO/DIO control word bit0	Bit 0 of <i>10.99 RO/DIO control word</i> (see page 318).	40
	RO/DIO control word bit1	Bit 1 of <i>10.99 RO/DIO control word</i> (see page 318).	41
	RO/DIO control word bit2	Bit 2 of <i>10.99 RO/DIO control word</i> (see page 318).	42
	Reserved		43...44
	PFC1	Bit 0 of <i>76.01 PFC status</i> (see page 484).	45

No.	Name/Value	Description	Def/FbEq16
	PFC2	Bit 1 of 76.01 PFC status (see page 484).	46
	PFC3	Bit 2 of 76.01 PFC status (see page 484).	47
	PFC4	Bit 3 of 76.01 PFC status (see page 484).	48
	PFC5	Bit 4 of 76.01 PFC status (see page 484).	49
	PFC6	Bit 5 of 76.01 PFC status (see page 484).	50
	Reserved		51...52
	Event word 1	Event word 1 = 1 if any bit of 04.40 Event word 1 (see page 294) is 1, that is, if any warning, fault or pure event that has been defined with parameters 04.41...04.71 is on.	53
	Reserved		54
	Run permissive	Bit 7 of 06.22 Hand-off-auto status word .	55
	Start interlock 1	Bit 8 of 06.22 Hand-off-auto status word .	56
	Start interlock 2	Bit 9 of 06.22 Hand-off-auto status word .	57
	Start interlock 3	Bit 10 of 06.22 Hand-off-auto status word .	58
	Start interlock 4	Bit 11 of 06.22 Hand-off-auto status word .	59
	All start interlocks	Bit 12 of 06.22 Hand-off-auto status word .	60
	User load curve	Bit 3 (Outside load limit) of 37.01 ULC output status word (see page 433).	61
	RO/DIO control word	For 15.07 RO4 source : Bit 3 (RO4) of 10.99 RO/DIO control word (see page 318). For 15.10 RO5 source : Bit 4 (RO5) of 10.99 RO/DIO control word (see page 318). For 15.13 RO6 source : Bit 5 (RO6) of 10.99 RO/DIO control word (see page 318). For 15.16 RO7 source : Bit 6 (RO7) of 10.99 RO/DIO control word (see page 318).	62
	<i>Other [bit]</i>	Source selection (see Terms and abbreviations on page 285).	-
15.08	RO4 ON delay	Defines the activation delay for relay output RO4.	0.0 s
<p> $t_{On} = 15.08$ RO4 ON delay $t_{Off} = 15.09$ RO4 OFF delay </p>			
	0.0 ... 3000.0 s	Activation delay for RO4.	1 = 1 s
15.09	RO4 OFF delay	Defines the deactivation delay for relay output RO4. See parameter 15.08 RO4 ON delay .	0.0 s
	0.0 ... 3000.0 s	Deactivation delay for RO4.	1 = 1 s
15.10	RO5 source	Selects a drive signal to be connected to relay output RO5. For the available selections, see parameter 15.07 RO4 source .	<i>Not energized</i>

No.	Name/Value	Description	Def/FbEq16
15.11	<i>RO5 ON delay</i>	Defines the activation delay for relay output RO5.	0.0 s
<p> $t_{On} = 15.11 \text{ RO5 ON delay}$ $t_{Off} = 15.12 \text{ RO5 OFF delay}$ </p>			
	0.0 ... 3000.0 s	Activation delay for RO5.	1 = 1 s
15.12	<i>RO5 OFF delay</i>	Defines the deactivation delay for relay output RO5. See parameter 15.11 RO5 ON delay .	0.0 s
	0.0 ... 3000.0 s	Deactivation delay for RO5.	1 = s
15.13	<i>RO6 source</i>	Selects a drive signal to be connected to relay output RO6. For the available selections, see parameter 15.07 RO4 source .	<i>Not energized</i>
15.14	<i>RO6 ON delay</i>	Defines the activation delay for relay output RO6.	0.0 s
<p> $t_{On} = 15.14 \text{ RO6 ON delay}$ $t_{Off} = 15.15 \text{ RO6 OFF delay}$ </p>			
	0.0 ... 3000.0 s	Activation delay for RO6.	10 = 1 s
15.15	<i>RO6 OFF delay</i>	Defines the deactivation delay for relay output RO6. See parameter 15.15 RO6 ON delay .	0.0 s
	0.0 ... 3000.0 s	Deactivation delay for RO6.	10 = 1 s
15.16	<i>RO7 source</i>	Selects a drive signal to be connected to relay output RO7. For the available selections, see parameter 15.07 RO4 source .	<i>Not energized</i>

No.	Name/Value	Description	Def/FbEq16
15.17	<i>RO7 ON delay</i>	Defines the activation delay for relay output RO7.	0.0 s
<p> $t_{On} = 15.17$ <i>RO7 ON delay</i> $t_{Off} = 15.18$ <i>RO7 OFF delay</i> </p>			
	0.0 ... 3000.0 s	Activation delay for RO7.	10 = 1 s
15.18	<i>RO7 OFF delay</i>	Defines the deactivation delay for relay output RO7. See parameter 15.17 RO7 ON delay .	0.0 s
	0.0 ... 3000.0 s	Deactivation delay for RO7.	10 = 1 s
15.22	<i>DO1 configuration</i>	Selects how DO1 is used.	<i>Digital output</i>
	Digital output	DO1 is used as a digital output.	0
	Frequency output	DO1 is used as a frequency output.	2
15.23	<i>DO1 source</i>	Selects a drive signal to be connected to digital output DO1 when 15.22 DO1 configuration is set to <i>Digital output</i> .	<i>Not energized</i>
	Not energized	Output is not energized.	0
	Energized	Output is energized.	1
	Ready run	Bit 1 of 06.11 Main status word (see page 299).	2
	Reserved		3
	Enabled	Bit 0 of 06.16 Drive status word 1 (see page 300).	4
	Started	Bit 5 of 06.16 Drive status word 1 (see page 300).	5
	Magnetized	Bit 1 of 06.17 Drive status word 2 (see page 301).	6
	Running	Bit 6 of 06.16 Drive status word 1 (see page 300).	7
	Ready ref	Bit 2 of 06.11 Main status word (see page 299).	8
	At setpoint	Bit 8 of 06.11 Main status word (see page 299).	9
	Reverse	Bit 2 of 06.19 Speed control status word (see page 302).	10
	Zero speed	Bit 0 of 06.19 Speed control status word (see page 302).	11
	Above limit	Bit 10 of 06.17 Drive status word 2 (see page 301).	12
	Warning	Bit 7 of 06.11 Main status word (see page 299).	13
	Fault	Bit 3 of 06.11 Main status word (see page 299).	14
	Fault (-1)	Inverted bit 3 of 06.11 Main status word (see page 299).	15
	Fault/Warning	Bit 3 of 06.11 Main status word OR bit 7 of 06.11 Main status word (see page 299).	16
	Overcurrent	Fault 2310 Overcurrent has occurred.	17
	Overvoltage	Fault 3210 DC link overvoltage has occurred.	18
	Drive temp	Fault 2381 IGBT overload , 4110 Control board temperature , 4210 IGBT overtemperature , 4290 Cooling , 42F1 IGBT temperature , 4310 Excess temperature or 4380 Excess temperature difference has occurred.	19

No.	Name/Value	Description	Def/FbEq16
	Undervoltage	Fault 3220 DC link undervoltage has occurred.	20
	Motor temp	Fault 4981 External temperature 1 or 4982 External temperature 2 has occurred.	21
	Reserved		22
	Ext2 active	Bit 11 of 06.16 Drive status word 1 (see page 300).	23
	Remote control	Bit 9 of 06.11 Main status word (see page 299).	24
	Reserved		25...26
	Timed function 1	Bit 0 of 34.01 Timed functions status (see page 410).	27
	Timed function 2	Bit 1 of 34.01 Timed functions status (see page 410).	28
	Timed function 3	Bit 2 of 34.01 Timed functions status (see page 410).	29
	Reserved		30...32
	Supervision 1	Bit 0 of 32.01 Supervision status (see page 403).	33
	Supervision 2	Bit 1 of 32.01 Supervision status (see page 403).	34
	Supervision 3	Bit 2 of 32.01 Supervision status (see page 403).	35
	Reserved		36...38
	Start delay	Bit 13 of 06.17 Drive status word 2 (see page 301).	39
	RO/DIO control word bit0	Bit 0 of 10.99 RO/DIO control word (see page 318).	40
	RO/DIO control word bit1	Bit 1 of 10.99 RO/DIO control word (see page 318).	41
	RO/DIO control word bit2	Bit 2 of 10.99 RO/DIO control word (see page 318).	42
	PFC1	Bit 0 of 76.01 PFC status (see page 484).	45
	PFC2	Bit 1 of 76.01 PFC status (see page 484).	46
	PFC3	Bit 2 of 76.01 PFC status (see page 484).	47
	PFC4	Bit 3 of 76.01 PFC status (see page 484).	48
	PFC5	Bit 4 of 76.01 PFC status (see page 484).	49
	PFC6	Bit 5 of 76.01 PFC status (see page 484).	50
	Reserved		51...52
	Event word 1	Event word 1 = 1 if any bit of 04.40 Event word 1 (see page 294) is 1, that is, if any warning, fault or pure event that has been defined with parameters 04.41...04.71 is on.	53
	Reserved		54
	Run permissive	Bit 7 of 06.22 Hand-off-auto status word .	55
	Start interlock 1	Bit 8 of 06.22 Hand-off-auto status word .	56
	Start interlock 2	Bit 9 of 06.22 Hand-off-auto status word .	57
	Start interlock 3	Bit 10 of 06.22 Hand-off-auto status word .	58
	Start interlock 4	Bit 11 of 06.22 Hand-off-auto status word .	59
	All start interlocks	Bit 12 of 06.22 Hand-off-auto status word .	60
	User load curve	Bit 3 (Outside load limit) of 37.01 ULC output status word (see page 433).	61
	RO/DIO control word	Bit 8 (DIO1) of 10.99 RO/DIO control word (see page 318).	62
	<i>Other [bit]</i>	Source selection (see Terms and abbreviations on page 285).	-

No.	Name/Value	Description	Def/FbEq16
15.24	<i>DO1 ON delay</i>	Defines the activation delay for digital output DO1 when <i>15.22 DO1 configuration</i> is set to <i>Digital output</i> .	0.0 s
<p>$t_{On} = 15.24 \text{ DO1 ON delay}$ $t_{Off} = 15.25 \text{ DO1 OFF delay}$</p>			
	0.0 ... 3000.0 s	Activation delay for DO1.	1 = 1 s
15.25	<i>DO1 OFF delay</i>	Defines the deactivation delay for relay output DO1 when <i>15.22 DO1 configuration</i> is set to <i>Digital output</i> . See parameter <i>15.24 DO1 ON delay</i> .	0.0 s
	0.0 ... 3000.0 s	Deactivation delay for DO1.	1 = 1 s
15.32	<i>Freq out 1 actual value</i>	Displays the value of frequency output 1 at digital output DO1 when <i>15.22 DO1 configuration</i> is set to <i>Frequency output</i> . This parameter is read-only.	-
	0 ... 16000 Hz	Value of frequency output 1.	1 = 1 Hz
15.33	<i>Freq out 1 source</i>	Selects a signal to be connected to digital output DO1 when <i>15.22 DO1 configuration</i> is set to <i>Frequency output</i> . Alternatively, sets the output to excitation mode to feed a constant current to a temperature sensor.	<i>Motor speed used</i>
	Not selected	None.	0
	Motor speed used	<i>01.01 Motor speed used</i> (page 288).	1
	Output frequency	<i>01.06 Output frequency</i> (page 288).	3
	Motor current	<i>01.07 Motor current</i> (page 288).	4
	Motor torque	<i>01.10 Motor torque</i> (page 288).	6
	DC voltage	<i>01.11 DC voltage</i> (page 288).	7
	Output power	<i>01.14 Output power</i> (page 289).	8
	Speed ref ramp in	<i>23.01 Speed ref ramp input</i> (page 370).	10
	Speed ref ramp out	<i>23.02 Speed ref ramp output</i> (page 370).	11
	Speed ref used	<i>24.01 Used speed reference</i> (page 371).	12
	Reserved		13
	Freq ref used	<i>28.02 Frequency ref ramp output</i> (page 377).	14
	Reserved		15
	Process PID out	<i>40.01 Process PID output actual</i> (page 437).	16
	<i>Other</i>	Source selection (see <i>Terms and abbreviations</i> on page 285).	-

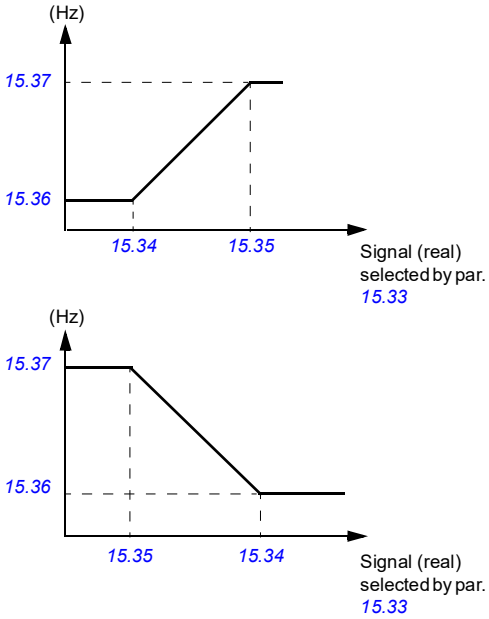
No.	Name/Value	Description	Def/FbEq16
15.34	<i>Freq out 1 src min</i>	<p>Defines the real value of the signal (selected by parameter 15.33 Freq out 1 source) that corresponds to the minimum value of frequency output 1 (defined by parameter 15.36 Freq out 1 at src min). This applies when 15.22 DO1 configuration is set to <i>Frequency output</i>.</p>  <p>(Hz)</p> <p>15.37</p> <p>15.36</p> <p>15.34 15.35</p> <p>Signal (real) selected by par. 15.33</p> <p>(Hz)</p> <p>15.37</p> <p>15.36</p> <p>15.35 15.34</p> <p>Signal (real) selected by par. 15.33</p>	0.000
	-32768.000... 32767.000	Real signal value corresponding to minimum value of frequency output 1.	1 = 1
15.35	<i>Freq out 1 src max</i>	<p>Defines the real value of the signal (selected by parameter 15.33 Freq out 1 source) that corresponds to the maximum value of frequency output 1 (defined by parameter 15.37 Freq out 1 at src max). This applies when 15.22 DO1 configuration is set to <i>Frequency output</i>. See parameter 15.34 Freq out 1 src min.</p>	1500.000; 1800.000 (95.20 b0)
	-32768.000... 32767.000	Real signal value corresponding to maximum value of frequency output 1.	1 = 1
15.36	<i>Freq out 1 at src min</i>	Defines the minimum output value of frequency output 1 when 15.22 DO1 configuration is set to <i>Frequency output</i> . See also drawing at parameter 15.34 Freq out 1 src min .	0 Hz
	0 ... 16000 Hz	Minimum frequency output 1 value.	1 = 1 Hz
15.37	<i>Freq out 1 at src max</i>	Defines the maximum value of frequency output 1 when 15.22 DO1 configuration is set to <i>Frequency output</i> . See also drawing at parameter 15.34 Freq out 1 src min .	16000 Hz
	0 ... 16000 Hz	Maximum value of frequency output 1.	1 = 1 Hz

No.	Name/Value	Description	Def/FbEq16
19 Operation mode			
		Selection of local and external control location sources and operating modes. See also section <i>Operating modes of the drive</i> (page 90).	
19.01	<i>Actual operation mode</i>	Displays the operating mode currently used. See parameter 19.11. This parameter is read-only.	-
	Zero	None.	1
	Speed	Speed control (in vector motor control mode).	2
	Reserved		3...9
	Scalar (Hz)	Frequency control in scalar motor control mode (in scalar motor control mode).	10
	Forced magn.	Motor is in magnetizing mode.	20
19.11	<i>Ext1/Ext2 selection</i>	Selects the source for external control location EXT1/EXT2 selection. 0 = EXT1 1 = EXT2	<i>EXT1</i>
	EXT1	EXT1 (permanently selected).	0
	EXT2	EXT2 (permanently selected).	1
	FBA A MCW bit 11	Control word bit 11 received through fieldbus interface A.	2
	DI1	Digital input DI1 (<i>10.02 DI delayed status</i> , bit 0).	3
	DI2	Digital input DI2 (<i>10.02 DI delayed status</i> , bit 1).	4
	DI3	Digital input DI3 (<i>10.02 DI delayed status</i> , bit 2).	5
	DI4	Digital input DI4 (<i>10.02 DI delayed status</i> , bit 3).	6
	DI5	Digital input DI5 (<i>10.02 DI delayed status</i> , bit 4).	7
	DI6	Digital input DI6 (<i>10.02 DI delayed status</i> , bit 5).	8
	Reserved		9...18
	Timed function 1	Bit 0 of <i>34.01 Timed functions status</i> (see page 410).	19
	Timed function 2	Bit 1 of <i>34.01 Timed functions status</i> (see page 410).	20
	Timed function 3	Bit 2 of <i>34.01 Timed functions status</i> (see page 410).	21
	Reserved		22...24
	Supervision 1	Bit 0 of <i>32.01 Supervision status</i> (see page 403).	25
	Supervision 2	Bit 1 of <i>32.01 Supervision status</i> (see page 403).	26
	Supervision 3	Bit 2 of <i>32.01 Supervision status</i> (see page 403).	27
	Reserved		28...31
	EFB MCW bit 11	Control word bit 11 received through the embedded fieldbus interface.	32
	FBA A connection loss	Detected communication loss of fieldbus interface A changes control mode to EXT2.	33
	EFB connection loss	Detected communication loss of embedded fieldbus interface changes control mode to EXT2.	34
	<i>Other [bit]</i>	Source selection (see <i>Terms and abbreviations</i> on page 285).	-

No.	Name/Value	Description	Def/FbEq16								
19.18	<i>HAND/OFF disable source</i>	Selects the source for Hand/Off disable. 1 = Hand and/or Off buttons are disabled on the control panel and in Drive composer PC tool. Parameter <i>19.19 HAND/OFF disable action</i> specifies which buttons are disabled or enabled. If the HAND/OFF disable is activated while the drive is in the Hand mode, the mode will be automatically switched to Off and the motor stops, and the user must start the motor again.	<i>Not used</i>								
	Not used	0 = Hand and/or Off buttons are enabled and operational.	0								
	Active	1 = Hand and/or Off buttons are disabled and not operational.	1								
	DI1	Digital input DI1 (<i>10.02 DI delayed status</i> , bit 0).	2								
	DI2	Digital input DI2 (<i>10.02 DI delayed status</i> , bit 1).	3								
	DI3	Digital input DI3 (<i>10.02 DI delayed status</i> , bit 2).	4								
	DI4	Digital input DI4 (<i>10.02 DI delayed status</i> , bit 3).	5								
	DI5	Digital input DI5 (<i>10.02 DI delayed status</i> , bit 4).	6								
	DI6	Digital input DI6 (<i>10.02 DI delayed status</i> , bit 5).	7								
	Comms	DCU profile control word bit 14 received through the embedded fieldbus interface. If a fieldbus adapter that supports transparent mode profiles is used, DCU control word bit 14 through the transparent mode profile is used.	8								
	<i>Other [bit]</i>	Source selection (see <i>Terms and abbreviations</i> on page 285).	-								
19.19	<i>HAND/OFF disable action</i>	Selects which buttons are disabled on the control panel and in the Drive composer PC tool when parameter <i>19.18 HAND/OFF disable source</i> is disabled.	<i>HAND</i>								
	HAND	Hand button disabled.	0								
	OFF and HAND	Both Off and Hand buttons disabled.	1								
	OFF when Auto	Off button is disabled when the drive is in the Auto mode. Off button is again enabled after the Hand button has been pressed.	2								
20 Start/stop/direction		Start/stop/direction and run/start enable signal source selection; positive/negative reference enable signal source selection. For information on control locations, see section <i>Local control vs. external control</i> (page 87).									
20.01	<i>Ext1 commands</i>	Selects the source of start, stop and direction commands for external control location 1 (EXT1). See also parameters <i>20.02...20.04</i> .	<i>In1 Start</i>								
	Not selected	No start or stop command sources selected.	0								
	In1 Start	The source of the start and stop commands is selected by parameter <i>20.03 Ext1 in1 source</i> . The state transitions of the source bits are interpreted as follows: <table border="1" data-bbox="341 1289 688 1396"> <thead> <tr> <th>State of source 1 (20.03)</th> <th>Command</th> </tr> </thead> <tbody> <tr> <td>0 -> 1 (<i>20.02 = Edge</i>)</td> <td>Start</td> </tr> <tr> <td>1 (<i>20.02 = Level</i>)</td> <td>Stop</td> </tr> <tr> <td>0</td> <td>Stop</td> </tr> </tbody> </table>	State of source 1 (20.03)	Command	0 -> 1 (<i>20.02 = Edge</i>)	Start	1 (<i>20.02 = Level</i>)	Stop	0	Stop	1
State of source 1 (20.03)	Command										
0 -> 1 (<i>20.02 = Edge</i>)	Start										
1 (<i>20.02 = Level</i>)	Stop										
0	Stop										

No.	Name/Value	Description	Def/FbEq16															
	In1 Start; In2 Dir	<p>The source selected by 20.03 Ext1 in1 source is the start signal; the source selected by 20.04 Ext1 in2 source determines the direction. The state transitions of the source bits are interpreted as follows:</p> <table border="1"> <thead> <tr> <th>State of source 1 (20.03)</th> <th>State of source 2 (20.04)</th> <th>Command</th> </tr> </thead> <tbody> <tr> <td>0</td> <td>Any</td> <td>Stop</td> </tr> <tr> <td>0 -> 1 (20.02 = Edge)</td> <td>0</td> <td>Start forward</td> </tr> <tr> <td>1 (20.02 = Level)</td> <td>1</td> <td>Start reverse</td> </tr> </tbody> </table>	State of source 1 (20.03)	State of source 2 (20.04)	Command	0	Any	Stop	0 -> 1 (20.02 = Edge)	0	Start forward	1 (20.02 = Level)	1	Start reverse	2			
State of source 1 (20.03)	State of source 2 (20.04)	Command																
0	Any	Stop																
0 -> 1 (20.02 = Edge)	0	Start forward																
1 (20.02 = Level)	1	Start reverse																
	In1 Start fwd; In2 Start rev	<p>The source selected by 20.03 Ext1 in1 source is the forward start signal; the source selected by 20.04 Ext1 in2 source is the reverse start signal. The state transitions of the source bits are interpreted as follows:</p> <table border="1"> <thead> <tr> <th>State of source 1 (20.03)</th> <th>State of source 2 (20.04)</th> <th>Command</th> </tr> </thead> <tbody> <tr> <td>0</td> <td>0</td> <td>Stop</td> </tr> <tr> <td>0 -> 1 (20.02 = Edge) 1 (20.02 = Level)</td> <td>0</td> <td>Start forward</td> </tr> <tr> <td>0</td> <td>0 -> 1 (20.02 = Edge) 1 (20.02 = Level)</td> <td>Start reverse</td> </tr> <tr> <td>1</td> <td>1</td> <td>Stop</td> </tr> </tbody> </table>	State of source 1 (20.03)	State of source 2 (20.04)	Command	0	0	Stop	0 -> 1 (20.02 = Edge) 1 (20.02 = Level)	0	Start forward	0	0 -> 1 (20.02 = Edge) 1 (20.02 = Level)	Start reverse	1	1	Stop	3
State of source 1 (20.03)	State of source 2 (20.04)	Command																
0	0	Stop																
0 -> 1 (20.02 = Edge) 1 (20.02 = Level)	0	Start forward																
0	0 -> 1 (20.02 = Edge) 1 (20.02 = Level)	Start reverse																
1	1	Stop																
	In1P Start; In2 Stop	<p>The sources of the start and stop commands are selected by parameters 20.03 Ext1 in1 source and 20.04 Ext1 in2 source. The state transitions of the source bits are interpreted as follows:</p> <table border="1"> <thead> <tr> <th>State of source 1 (20.03)</th> <th>State of source 2 (20.04)</th> <th>Command</th> </tr> </thead> <tbody> <tr> <td>0 -> 1</td> <td>1</td> <td>Start</td> </tr> <tr> <td>Any</td> <td>0</td> <td>Stop</td> </tr> </tbody> </table> <p>Notes:</p> <ul style="list-style-type: none"> • Run permissive and Start interlock signals can be put ON before or after the start pulse has been given. • Parameter 20.02 Ext1 start trigger type has an effect only at startup of the drive with this setting. If the start input is ON and 20.02 = Level (1) when the drive is powered up, the motor will start. 	State of source 1 (20.03)	State of source 2 (20.04)	Command	0 -> 1	1	Start	Any	0	Stop	4						
State of source 1 (20.03)	State of source 2 (20.04)	Command																
0 -> 1	1	Start																
Any	0	Stop																

No.	Name/Value	Description	Def/FbEq16																
	In1P Start; In2 Stop; In3 Dir	<p>The sources of the start and stop commands are selected by parameters 20.03 Ext1 in1 source and 20.04 Ext1 in2 source. The source selected by 20.05 Ext1 in3 source determines the direction. The state transitions of the source bits are interpreted as follows:</p> <table border="1" data-bbox="340 300 847 448"> <thead> <tr> <th data-bbox="340 300 465 363">State of source 1 (20.03)</th> <th data-bbox="465 300 591 363">State of source 2 (20.04)</th> <th data-bbox="591 300 716 363">State of source 3 (20.05)</th> <th data-bbox="716 300 847 363">Command</th> </tr> </thead> <tbody> <tr> <td data-bbox="340 363 465 392">0 -> 1</td> <td data-bbox="465 363 591 392">1</td> <td data-bbox="591 363 716 392">0</td> <td data-bbox="716 363 847 392">Start forward</td> </tr> <tr> <td data-bbox="340 392 465 421">0 -> 1</td> <td data-bbox="465 392 591 421">1</td> <td data-bbox="591 392 716 421">1</td> <td data-bbox="716 392 847 421">Start reverse</td> </tr> <tr> <td data-bbox="340 421 465 448">Any</td> <td data-bbox="465 421 591 448">0</td> <td data-bbox="591 421 716 448">Any</td> <td data-bbox="716 421 847 448">Stop</td> </tr> </tbody> </table> <p>Notes:</p> <ul style="list-style-type: none"> Run permissive and Start interlock signals can be put ON before or after the start pulse has been given. Parameter 20.02 Ext1 start trigger type has an effect only at startup of the drive with this setting. If the start input is ON and 20.02 = Level (1) when the drive is powered up, the motor will start. 	State of source 1 (20.03)	State of source 2 (20.04)	State of source 3 (20.05)	Command	0 -> 1	1	0	Start forward	0 -> 1	1	1	Start reverse	Any	0	Any	Stop	5
State of source 1 (20.03)	State of source 2 (20.04)	State of source 3 (20.05)	Command																
0 -> 1	1	0	Start forward																
0 -> 1	1	1	Start reverse																
Any	0	Any	Stop																
	In1P Start fwd; In2P Start rev; In3 Stop	<p>The sources of the start and stop commands are selected by parameters 20.03 Ext1 in1 source, 20.04 Ext1 in2 source and 20.05 Ext1 in3 source. The source selected by 20.05 Ext1 in3 source determines the stop. The state transitions of the source bits are interpreted as follows</p> <table border="1" data-bbox="340 756 847 904"> <thead> <tr> <th data-bbox="340 756 465 820">State of source 1 (20.03)</th> <th data-bbox="465 756 591 820">State of source 2 (20.04)</th> <th data-bbox="591 756 716 820">State of source 3 (20.05)</th> <th data-bbox="716 756 847 820">Command</th> </tr> </thead> <tbody> <tr> <td data-bbox="340 820 465 849">0 -> 1</td> <td data-bbox="465 820 591 849">Any</td> <td data-bbox="591 820 716 849">1</td> <td data-bbox="716 820 847 849">Start forward</td> </tr> <tr> <td data-bbox="340 849 465 877">Any</td> <td data-bbox="465 849 591 877">0 -> 1</td> <td data-bbox="591 849 716 877">1</td> <td data-bbox="716 849 847 877">Start reverse</td> </tr> <tr> <td data-bbox="340 877 465 904">Any</td> <td data-bbox="465 877 591 904">Any</td> <td data-bbox="591 877 716 904">0</td> <td data-bbox="716 877 847 904">Stop</td> </tr> </tbody> </table> <p>Notes:</p> <ul style="list-style-type: none"> Run permissive and Start interlock signals can be put ON before or after the start pulse has been given. Parameter 20.02 Ext1 start trigger type has no effect with this setting. 	State of source 1 (20.03)	State of source 2 (20.04)	State of source 3 (20.05)	Command	0 -> 1	Any	1	Start forward	Any	0 -> 1	1	Start reverse	Any	Any	0	Stop	6
State of source 1 (20.03)	State of source 2 (20.04)	State of source 3 (20.05)	Command																
0 -> 1	Any	1	Start forward																
Any	0 -> 1	1	Start reverse																
Any	Any	0	Stop																
	Reserved		7...10																
	Control panel	<p>The start and stop commands are taken from the control panel (or PC connected to the control panel connector).</p> <p>Note: This selection requires ACS-AP-I control panel that uses Start/Stop/Loc/Rem logic.</p>	11																
	Fieldbus A	<p>The start and stop commands are taken from fieldbus adapter A.</p> <p>Note: Set also 20.02 Ext1 start trigger type to <i>Level</i>.</p>	12																
	Reserved		13																
	Embedded fieldbus	<p>The start and stop commands are taken from the embedded fieldbus interface.</p> <p>Note: Set also 20.02 Ext1 start trigger type to <i>Level</i>.</p>	14																

No.	Name/Value	Description	Def/FbEq16								
20.02	<i>Ext1 start trigger type</i>	Defines whether the start signal for external control location EXT1 is edge-triggered or level-triggered. Note: If a pulse type start signal is selected, this parameter is only effective at drive startup. See the descriptions of the selections of parameter 20.01 Ext1 commands .	<i>Level</i>								
	Edge	The start signal is edge-triggered.	0								
	Level	The start signal is level-triggered.	1								
20.03	<i>Ext1 in1 source</i>	Selects source 1 for parameter 20.01 Ext1 commands .	<i>DI1</i>								
	Always off	0.	0								
	Always on	1.	1								
	DI1	Digital input DI1 (10.02 DI delayed status , bit 0).	2								
	DI2	Digital input DI2 (10.02 DI delayed status , bit 1).	3								
	DI3	Digital input DI3 (10.02 DI delayed status , bit 2).	4								
	DI4	Digital input DI4 (10.02 DI delayed status , bit 3).	5								
	DI5	Digital input DI5 (10.02 DI delayed status , bit 4).	6								
	DI6	Digital input DI6 (10.02 DI delayed status , bit 5).	7								
	Reserved		8...17								
	Timed function 1	Bit 0 of 34.01 Timed functions status (see page 410).	18								
	Timed function 2	Bit 1 of 34.01 Timed functions status (see page 410).	19								
	Timed function 3	Bit 2 of 34.01 Timed functions status (see page 410).	20								
	Reserved		21...23								
	Supervision 1	Bit 0 of 32.01 Supervision status (see page 403).	24								
	Supervision 2	Bit 1 of 32.01 Supervision status (see page 403).	25								
	Supervision 3	Bit 2 of 32.01 Supervision status (see page 403).	26								
	Reserved		27...39								
	Constant speed	Bit 7 of 06.19 Speed control status word (see page 302).	40								
	<i>Other [bit]</i>	Source selection (see Terms and abbreviations on page 285).	-								
20.04	<i>Ext1 in2 source</i>	Selects source 2 for parameter 20.01 Ext1 commands . For the available selections, see parameter 20.03 Ext1 in1 source .	<i>Always off</i>								
20.05	<i>Ext1 in3 source</i>	Selects source 3 for parameter 20.01 Ext1 commands . For the available selections, see parameter 20.03 Ext1 in1 source .	<i>Always off</i>								
20.06	<i>Ext2 commands</i>	Selects the source of start, stop and direction commands for external control location 2 (EXT2). See parameter 20.21 for the determination of the actual direction. See also parameters 20.07...20.10 .	<i>Not selected</i>								
	Not selected	No start or stop command sources selected.	0								
	In1 Start	The source of the start and stop commands is selected by parameter 20.08 Ext2 in1 source . The state transitions of the source bits are interpreted as follows: <table border="1" data-bbox="392 1369 739 1476"> <thead> <tr> <th>State of source 1 (20.08)</th> <th>Command</th> </tr> </thead> <tbody> <tr> <td>0 -> 1 (20.07 = Edge)</td> <td>Start</td> </tr> <tr> <td>1 (20.07 = Level)</td> <td>Stop</td> </tr> <tr> <td>0</td> <td>Stop</td> </tr> </tbody> </table>	State of source 1 (20.08)	Command	0 -> 1 (20.07 = Edge)	Start	1 (20.07 = Level)	Stop	0	Stop	1
State of source 1 (20.08)	Command										
0 -> 1 (20.07 = Edge)	Start										
1 (20.07 = Level)	Stop										
0	Stop										

No.	Name/Value	Description	Def/FbEq16															
	In1 Start; In2 Dir	<p>The source selected by 20.08 Ext2 in1 source is the start signal; the source selected by 20.09 Ext2 in2 source determines the direction. The state transitions of the source bits are interpreted as follows:</p> <table border="1"> <thead> <tr> <th>State of source 1 (20.08)</th> <th>State of source 2 (20.09)</th> <th>Command</th> </tr> </thead> <tbody> <tr> <td>0</td> <td>Any</td> <td>Stop</td> </tr> <tr> <td>0 -> 1 (20.07 = Edge)</td> <td>0</td> <td>Start forward</td> </tr> <tr> <td>1 (20.07 = Level)</td> <td>1</td> <td>Start reverse</td> </tr> </tbody> </table>	State of source 1 (20.08)	State of source 2 (20.09)	Command	0	Any	Stop	0 -> 1 (20.07 = Edge)	0	Start forward	1 (20.07 = Level)	1	Start reverse	2			
State of source 1 (20.08)	State of source 2 (20.09)	Command																
0	Any	Stop																
0 -> 1 (20.07 = Edge)	0	Start forward																
1 (20.07 = Level)	1	Start reverse																
	In1 Start fwd; In2 Start rev	<p>The source selected by 20.08 Ext2 in1 source is the forward start signal; the source selected by 20.09 Ext2 in2 source is the reverse start signal. The state transitions of the source bits are interpreted as follows:</p> <table border="1"> <thead> <tr> <th>State of source 1 (20.08)</th> <th>State of source 2 (20.09)</th> <th>Command</th> </tr> </thead> <tbody> <tr> <td>0</td> <td>0</td> <td>Stop</td> </tr> <tr> <td>0 -> 1 (20.07 = Edge) 1 (20.07 = Level)</td> <td>0</td> <td>Start forward</td> </tr> <tr> <td>0</td> <td>0 -> 1 (20.07 = Edge) 1 (20.07 = Level)</td> <td>Start reverse</td> </tr> <tr> <td>1</td> <td>1</td> <td>Stop</td> </tr> </tbody> </table>	State of source 1 (20.08)	State of source 2 (20.09)	Command	0	0	Stop	0 -> 1 (20.07 = Edge) 1 (20.07 = Level)	0	Start forward	0	0 -> 1 (20.07 = Edge) 1 (20.07 = Level)	Start reverse	1	1	Stop	3
State of source 1 (20.08)	State of source 2 (20.09)	Command																
0	0	Stop																
0 -> 1 (20.07 = Edge) 1 (20.07 = Level)	0	Start forward																
0	0 -> 1 (20.07 = Edge) 1 (20.07 = Level)	Start reverse																
1	1	Stop																
	In1P Start; In2 Stop	<p>The sources of the start and stop commands are selected by parameters 20.08 Ext2 in1 source and 20.09 Ext2 in2 source. The state transitions of the source bits are interpreted as follows:</p> <table border="1"> <thead> <tr> <th>State of source 1 (20.08)</th> <th>State of source 2 (20.09)</th> <th>Command</th> </tr> </thead> <tbody> <tr> <td>0 -> 1</td> <td>1</td> <td>Start</td> </tr> <tr> <td>Any</td> <td>0</td> <td>Stop</td> </tr> </tbody> </table> <p>Notes:</p> <ul style="list-style-type: none"> Run permissive and Start interlock signals can be put ON before or after the start pulse has been given. Parameter 20.07 Ext2 start trigger type has an effect only at startup of the drive with this setting. If the start input is ON and 20.07 = Level (1) when the drive is powered up, the motor will start. 	State of source 1 (20.08)	State of source 2 (20.09)	Command	0 -> 1	1	Start	Any	0	Stop	4						
State of source 1 (20.08)	State of source 2 (20.09)	Command																
0 -> 1	1	Start																
Any	0	Stop																

No.	Name/Value	Description	Def/FbEq16																
	In1P Start; In2 Stop; In3 Dir	<p>The sources of the start and stop commands are selected by parameters 20.08 Ext2 in1 source and 20.09 Ext2 in2 source. The source selected by 20.10 Ext2 in3 source determines the direction. The state transitions of the source bits are interpreted as follows:</p> <table border="1"> <thead> <tr> <th>State of source 1 (20.08)</th> <th>State of source 2 (20.09)</th> <th>State of source 3 (20.10)</th> <th>Command</th> </tr> </thead> <tbody> <tr> <td>0 -> 1</td> <td>1</td> <td>0</td> <td>Start forward</td> </tr> <tr> <td>0 -> 1</td> <td>1</td> <td>1</td> <td>Start reverse</td> </tr> <tr> <td>Any</td> <td>0</td> <td>Any</td> <td>Stop</td> </tr> </tbody> </table> <p>Notes:</p> <ul style="list-style-type: none"> Run permissive and Start interlock signals can be put ON before or after the start pulse has been given. Parameter 20.07 Ext2 start trigger type has an effect only at startup of the drive with this setting. If the start input is ON and 20.07 = Level (1) when the drive is powered up, the motor will start. 	State of source 1 (20.08)	State of source 2 (20.09)	State of source 3 (20.10)	Command	0 -> 1	1	0	Start forward	0 -> 1	1	1	Start reverse	Any	0	Any	Stop	5
State of source 1 (20.08)	State of source 2 (20.09)	State of source 3 (20.10)	Command																
0 -> 1	1	0	Start forward																
0 -> 1	1	1	Start reverse																
Any	0	Any	Stop																
	In1P Start fwd; In2P Start rev; In3 Stop	<p>The sources of the start and stop commands are selected by parameters 20.08 Ext2 in1 source, 20.09 Ext2 in2 source and 20.10 Ext2 in3 source. The source selected by 20.10 Ext2 in3 source determines the direction. The state transitions of the source bits are interpreted as follows:</p> <table border="1"> <thead> <tr> <th>State of source 1 (20.08)</th> <th>State of source 2 (20.09)</th> <th>State of source 3 (20.10)</th> <th>Command</th> </tr> </thead> <tbody> <tr> <td>0 -> 1</td> <td>Any</td> <td>1</td> <td>Start forward</td> </tr> <tr> <td>Any</td> <td>0 -> 1</td> <td>1</td> <td>Start reverse</td> </tr> <tr> <td>Any</td> <td>Any</td> <td>0</td> <td>Stop</td> </tr> </tbody> </table> <p>Notes:</p> <ul style="list-style-type: none"> Run permissive and Start interlock signals can be put ON before or after the start pulse has been given. Parameter 20.07 Ext2 start trigger type has no effect with this setting. 	State of source 1 (20.08)	State of source 2 (20.09)	State of source 3 (20.10)	Command	0 -> 1	Any	1	Start forward	Any	0 -> 1	1	Start reverse	Any	Any	0	Stop	6
State of source 1 (20.08)	State of source 2 (20.09)	State of source 3 (20.10)	Command																
0 -> 1	Any	1	Start forward																
Any	0 -> 1	1	Start reverse																
Any	Any	0	Stop																
	Reserved		7...10																
	Control panel	<p>The start and stop commands are taken from the control panel (or PC connected to the control panel connector).</p> <p>Note: This selection requires ACS-AP-I control panel that uses Start/Stop/Loc/Rem logic.</p>	11																
	Fieldbus A	<p>The start and stop commands are taken from fieldbus adapter A.</p> <p>Note: Set also 20.07 Ext2 start trigger type to Level.</p>	12																
	Reserved		13																
	Embedded fieldbus	<p>The start and stop commands are taken from the embedded fieldbus interface.</p> <p>Note: Set also 20.07 Ext2 start trigger type to Level.</p>	14																

No.	Name/Value	Description	Def/FbEq16
20.07	<i>Ext2 start trigger type</i>	Defines whether the start signal for external control location EXT2 is edge-triggered or level-triggered. Note: If a pulse type start signal is selected, this parameter is only effective at drive startup. See the descriptions of the selections of parameter <i>20.06 Ext2 commands</i> .	<i>Level</i>
	Edge	The start signal is edge-triggered.	0
	Level	The start signal is level-triggered.	1
20.08	<i>Ext2 in1 source</i>	Selects source 1 for parameter <i>20.06 Ext2 commands</i> . For the available selections, see parameter <i>20.03 Ext1 in1 source</i> .	<i>Always off</i>
20.09	<i>Ext2 in2 source</i>	Selects source 2 for parameter <i>20.06 Ext2 commands</i> . For the available selections, see parameter <i>20.03 Ext1 in1 source</i> .	<i>Always off</i>
20.10	<i>Ext2 in3 source</i>	Selects source 3 for parameter <i>20.06 Ext2 commands</i> . For the available selections, see parameter <i>20.03 Ext1 in1 source</i> .	<i>Always off</i>

No.	Name/Value	Description	Def/FbEq16
20.21	<i>Direction</i>	Reference direction lock. Defines the direction of the drive rather than the sign of the reference, except in some cases. In the table the actual drive rotation is shown as a function of parameter <i>20.21 Direction</i> and Direction command (from parameter <i>20.01 Ext1 commands</i> or <i>20.06 Ext2 commands</i>). See control chain diagram <i>Direction lock</i> (page 282)	<i>Forward</i>
		Direction command = Forward	Direction command = Reverse
	Par. <i>20.21 Direction</i> = <i>Forward</i>	Forward	Forward
	Par. <i>20.21 Direction</i> = <i>Reverse</i>	Reverse	Reverse
	Par. <i>20.21 Direction</i> = <i>Request</i>	Forward, but <ul style="list-style-type: none"> If reference from Constant, Floating point control (Motor potentiometer), PID, Safe speed, Last or Panel reference, reference used as is. If reference from the network, reference used as is. 	Reverse, but <ul style="list-style-type: none"> If reference from Constant or PID, reference used as is. If reference from the network, Panel, Analog input, Floating point control (Motor potentiometer), Safe speed or Last reference, reference multiplied by -1.
	Request	In external control the direction is selected by a direction command (parameter <i>20.01 Ext1 commands</i> or <i>20.06 Ext2 commands</i>). If the reference comes from Constant (constant speeds/frequencies), Floating point control (Motor potentiometer), PID, Speed ref safe, Last speed reference or Panel reference, the reference is used as is. If the reference comes from a fieldbus: <ul style="list-style-type: none"> if the direction command is forward, the reference is used as is if the direction command is reverse, the reference is multiplied by -1. 	0
	Forward	Motor rotates forward regardless of the sign of the external reference. (Negative reference values are replaced by zero. Positive reference values are used as is.)	1
	Reverse	Motor rotates reverse regardless of the sign of the external reference. (Negative reference values are replaced by zero. Positive reference values are multiplied by -1.)	2

No.	Name/Value	Description	Def/FbEq16												
20.30	<i>Enable signal warning function</i>	Selects enable signal warnings to be suppressed. This parameter can be used to prevent these warnings from flooding the event log. Whenever a bit of this parameter is set to 1, the corresponding warning is suppressed.	0000h												
<table border="1"> <thead> <tr> <th>Bit</th> <th>Name</th> <th>Description</th> </tr> </thead> <tbody> <tr> <td>0</td> <td>Run permissive</td> <td>1 = Warning <i>AFED Run permissive</i> is suppressed.</td> </tr> <tr> <td>1</td> <td>Start interlocks</td> <td>1 = Following warnings are suppressed: <ul style="list-style-type: none"> • <i>AFEE Start interlock 1</i> • <i>AFEF Start interlock 2</i> • <i>AFF0 Start interlock 3</i> • <i>AFF1 Start interlock 4</i> </td> </tr> <tr> <td>3...15</td> <td>Reserved</td> <td></td> </tr> </tbody> </table>				Bit	Name	Description	0	Run permissive	1 = Warning <i>AFED Run permissive</i> is suppressed.	1	Start interlocks	1 = Following warnings are suppressed: <ul style="list-style-type: none"> • <i>AFEE Start interlock 1</i> • <i>AFEF Start interlock 2</i> • <i>AFF0 Start interlock 3</i> • <i>AFF1 Start interlock 4</i> 	3...15	Reserved	
Bit	Name	Description													
0	Run permissive	1 = Warning <i>AFED Run permissive</i> is suppressed.													
1	Start interlocks	1 = Following warnings are suppressed: <ul style="list-style-type: none"> • <i>AFEE Start interlock 1</i> • <i>AFEF Start interlock 2</i> • <i>AFF0 Start interlock 3</i> • <i>AFF1 Start interlock 4</i> 													
3...15	Reserved														
	0000h...FFFFh	Word for disabling enable signal warnings.	1 = 1												
20.40	<i>Run permissive</i>	Selects the source of the Run permissive signal. Value 0 of the source deactivates the Run permissive and prevents running. Value 1 of the source activates the Run permissive and permits running.	<i>Not used</i>												
	Not used	0.	0												
	Not used	1.	1												
	DI1	Digital input DI1 (<i>10.02 DI delayed status</i> , bit 0).	2												
	DI2	Digital input DI2 (<i>10.02 DI delayed status</i> , bit 1).	3												
	DI3	Digital input DI3 (<i>10.02 DI delayed status</i> , bit 2).	4												
	DI4	Digital input DI4 (<i>10.02 DI delayed status</i> , bit 3).	5												
	DI5	Digital input DI5 (<i>10.02 DI delayed status</i> , bit 4).	6												
	DI6	Digital input DI6 (<i>10.02 DI delayed status</i> , bit 5).	7												
	-DI1	Digital input DI1 (<i>10.02 DI delayed status</i> , bit 0).	8												
	-DI2	Digital input DI2 (<i>10.02 DI delayed status</i> , bit 1).	9												
	-DI3	Digital input DI3 (<i>10.02 DI delayed status</i> , bit 2).	10												
	-DI4	Digital input DI4 (<i>10.02 DI delayed status</i> , bit 3).	11												
	-DI5	Digital input DI5 (<i>10.02 DI delayed status</i> , bit 4).	12												
	-DI6	Digital input DI6 (<i>10.02 DI delayed status</i> , bit 5).	13												
	Fieldbus adapter	Control word bit 3 received through the fieldbus interface.	14												
	Embedded fieldbus	ABB Drives profile: Control word bit 3 received through the embedded fieldbus interface DCU profile: Inverse of control word bit 6 received through the embedded fieldbus interface.	15												
	<i>Other [bit]</i>	Source selection (see <i>Terms and abbreviations</i> on page 285).	-												
20.41	<i>Start interlock 1</i>	Selects the source of the Start interlock 1 signal. Value 0 of the source deactivates the Start interlock 1 signal and inhibits starting. Value 1 of the source activates the Start interlock 1 signal and allows starting.	<i>Not used</i>												
	Not used	0.	0												
	Not used	1.	1												

No.	Name/Value	Description	Def/FbEq16
	DI1	Digital input DI1 (<i>10.02 DI delayed status</i> , bit 0).	2
	DI2	Digital input DI2 (<i>10.02 DI delayed status</i> , bit 1).	3
	DI3	Digital input DI3 (<i>10.02 DI delayed status</i> , bit 2).	4
	DI4	Digital input DI4 (<i>10.02 DI delayed status</i> , bit 3).	5
	DI5	Digital input DI5 (<i>10.02 DI delayed status</i> , bit 4).	6
	DI6	Digital input DI6 (<i>10.02 DI delayed status</i> , bit 5).	7
	-DI1	Digital input DI1 (<i>10.02 DI delayed status</i> , bit 0).	8
	-DI2	Digital input DI2 (<i>10.02 DI delayed status</i> , bit 1).	9
	-DI3	Digital input DI3 (<i>10.02 DI delayed status</i> , bit 2).	10
	-DI4	Digital input DI4 (<i>10.02 DI delayed status</i> , bit 3).	11
	-DI5	Digital input DI5 (<i>10.02 DI delayed status</i> , bit 4).	12
	-DI6	Digital input DI6 (<i>10.02 DI delayed status</i> , bit 5).	13
	Fieldbus adapter	This selection cannot be used to control Start interlock with ABB drives profile from the fieldbus adapter. Use <i>Other [bit]</i> and map to control word user bits. This selection is only available for <i>20.41 Start interlock 1</i> and <i>20.42 Start interlock 2</i> .	14
	Embedded fieldbus	Start interlock 1: DCU profile: Inverse of control word bit 18 received through the embedded fieldbus interface. Start interlock 2: Inverse of bit 19. This selection is only available for <i>20.41 Start interlock 1</i> and <i>20.42 Start interlock 2</i> .	15
	<i>Other [bit]</i>	Source selection (see <i>Terms and abbreviations</i> on page 285).	-
<i>20.42</i>	<i>Start interlock 2</i>	Selects the source of the Start interlock 2 signal. For the selections, see parameter <i>20.41 Start interlock 1</i> .	<i>Not used</i>
<i>20.43</i>	<i>Start interlock 3</i>	Selects the source of the Start interlock 3 signal. Start interlock 3 is not supported over the Fieldbus adapter or Embedded fieldbus. For the other selections than 14 and 15, see parameter <i>20.41 Start interlock 1</i> .	<i>Not used</i>
<i>20.44</i>	<i>Start interlock 4</i>	Selects the source of the Start interlock 4 signal. Start interlock 4 is not supported over the Fieldbus adapter or Embedded fieldbus. For the other selections than 14 and 15, see parameter <i>20.41 Start interlock 1</i> .	<i>Not used</i>
<i>20.45</i>	<i>Start interlock stop mode</i>	Follows motor stop mode selection, see parameter <i>21.03 Stop mode</i> .	<i>Not used</i>
	Not used	Not in use.	0
	Coast	The motor coasts to a stop.	1
	Ramp	Stop along the active deceleration ramp.	2
<i>20.46</i>	<i>Run permissive text</i>	Alternative alarm texts for the run permissive. There is also label text (free text) for the run permissive. The control panel display will display the text when the run permissive becomes unsatisfied. You edit the label text in Menu > Primary settings > Start, stop, reference > Interlocks/Permissives > Label text .	<i>Run permissive</i>
	Run permissive		0
	Reserved		1

No.	Name/Value	Description	Def/FbEq16
	Valve opening		2
	Pre-lube cycle		3
	Interlock open		5
20.47	<i>Start interlock 1 text</i>	Alternative alarm texts for the start interlock 1. There is also label text (free text) for each start interlock. The control panel display will display that specific text when the interlock becomes unsatisfied. You edit the label text in Menu > Primary settings > Start, stop, reference > Interlocks/Permissives > Label text.	<i>Start interlock 1</i>
	Start interlock 1		0
	Vibration switch		1
	Reserved		2...3
	Overpressure		4
	Vibration trip		5
	Reserved		6...7
	Low suction		8
	Low pressure		9
	Reserved		10
	Pressure relief		11
	Motor disconnect open		12
	Safety option		14
	Interlock open		15
20.48	<i>Start interlock 2 text</i>	Alternative alarm texts for the start interlock 2. See parameter 20.47 Start interlock 1 text .	<i>Start interlock 2</i>
	Start interlock 2	For other selections, see parameter 20.47 Start interlock 1 text .	0
20.49	<i>Start interlock 3 text</i>	Alternative alarm texts for the start interlock 3. See parameter 20.47 Start interlock 1 text .	<i>Start interlock 3</i>
	Start interlock 3	For other selections, see parameter 20.47 Start interlock 1 text .	0
20.50	<i>Start interlock 4 text</i>	Alternative alarm texts for the start interlock 4. See parameter 20.47 Start interlock 1 text .	<i>Start interlock 4</i>
	Start interlock 4	For other selections, see parameter 20.47 Start interlock 1 text .	0
20.51	<i>Start interlock condition</i>	Selects the condition for start interlock function. This parameter determines if the start command is needed before start interlock warnings are displayed.	<i>Start command ignored</i>
	Start command ignored	Start interlock warnings are displayed if the interlocks are missing.	0
	Start command required	Start command must be present before the start interlock warnings are displayed if the interlocks are missing.	1

No.	Name/Value	Description	Def/FbEq16
21 Start/stop mode		Start and stop modes; emergency stop mode and signal source selection; DC magnetization settings.	
21.01	<i>Start mode</i>	<p>Selects the motor start function for the vector motor control mode, ie, when 99.04 Motor control mode is set to Vector.</p> <p>Notes:</p> <ul style="list-style-type: none"> The start function for the scalar motor control mode is selected by parameter 21.19 Scalar start mode. Starting into a rotating motor is not possible when DC magnetizing is selected (Fast or Const time). With permanent magnet motors, Automatic start mode must be used. This parameter cannot be changed while the drive is running. <p>See also section Start methods – DC magnetization (page 150).</p>	<i>Automatic</i>
	Fast	The drive pre-magnetizes the motor before start. The pre-magnetizing time is determined automatically, being typically 200 ms to 2 s depending on motor size. This mode should be selected if a high break-away torque is required.	0
	Const time	<p>The drive pre-magnetizes the motor before start. The pre-magnetizing time is defined by parameter 21.02 Magnetization time. This mode should be selected if constant pre-magnetizing time is required (for example, if the motor start must be synchronized with the release of a mechanical brake). This setting also guarantees the highest possible break-away torque when the pre-magnetizing time is set long enough.</p> <p> WARNING! The drive will start after the set magnetizing time has passed even if motor magnetization is not completed. In applications where a full break-away torque is essential, ensure that the constant magnetizing time is long enough to allow generation of full magnetization and torque.</p>	1
	Automatic	Automatic start guarantees optimal motor start in most cases. It includes the flying start function (starting into a rotating motor) and the automatic restart function. The drive motor control program identifies the flux as well as the mechanical state of the motor and starts the motor instantly under all conditions.	2

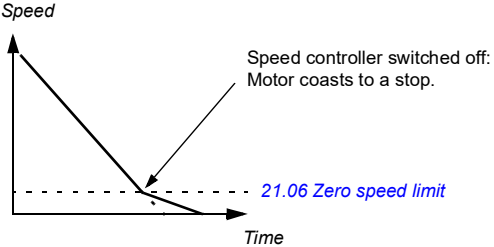
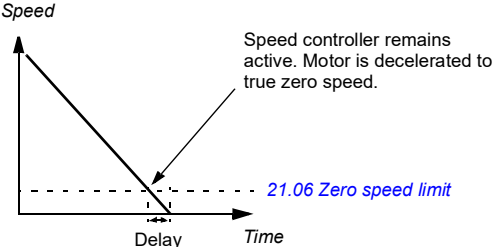

No.	Name/Value	Description	Def/FbEq16										
21.02	<i>Magnetization time</i>	<p>Defines the pre-magnetization time when</p> <ul style="list-style-type: none"> parameter <i>21.01 Start mode</i> is set to <i>Const time</i> (in vector motor control mode), or parameter <i>21.19 Scalar start mode</i> is set to <i>Const time</i> (in scalar motor control mode). <p>After the start command, the drive automatically premagnetizes the motor for the set time. To ensure full magnetizing, set this parameter to the same value as, or higher than, the rotor time constant. If not known, use the rule-of-thumb value given in the table below:</p> <table border="1"> <thead> <tr> <th>Motor rated power</th> <th>Constant magnetizing time</th> </tr> </thead> <tbody> <tr> <td>< 1 kW</td> <td>≥ 50 to 100 ms</td> </tr> <tr> <td>1 to 10 kW</td> <td>≥ 100 to 200 ms</td> </tr> <tr> <td>10 to 200 kW</td> <td>≥ 200 to 1000 ms</td> </tr> <tr> <td>200 to 1000 kW</td> <td>≥ 1000 to 2000 ms</td> </tr> </tbody> </table> <p>Note: This parameter cannot be changed while the drive is running.</p>	Motor rated power	Constant magnetizing time	< 1 kW	≥ 50 to 100 ms	1 to 10 kW	≥ 100 to 200 ms	10 to 200 kW	≥ 200 to 1000 ms	200 to 1000 kW	≥ 1000 to 2000 ms	500 ms
Motor rated power	Constant magnetizing time												
< 1 kW	≥ 50 to 100 ms												
1 to 10 kW	≥ 100 to 200 ms												
10 to 200 kW	≥ 200 to 1000 ms												
200 to 1000 kW	≥ 1000 to 2000 ms												
	0...10000 ms	Constant DC magnetizing time.	1 = 1 ms										
21.03	<i>Stop mode</i>	<p>Selects the way the motor is stopped when a stop command is received.</p> <p>Additional braking is possible by selecting flux braking (see parameter <i>97.05 Flux braking</i>).</p>	<i>Ramp</i>										
	Coast	<p>Stop by switching off the output semiconductors of the drive. The motor coasts to a stop.</p> <p> WARNING! If a mechanical brake is used, ensure it is safe to stop the drive by coasting.</p>	0										
	Ramp	<p>Stop along the active deceleration ramp. See parameter group <i>23 Speed reference ramp</i> on page <i>370</i> or <i>28 Frequency reference chain</i> on page <i>377</i>.</p>	1										
	Torque limit	<p>Stop according to torque limits (parameters <i>30.19</i> and <i>30.20</i>). This mode is only possible in vector motor control mode.</p>	2										
21.04	<i>Emergency stop mode</i>	<p>Selects the way the motor is stopped when an emergency stop command is received.</p> <p>The source of the emergency stop signal is selected by parameter <i>21.05 Emergency stop source</i>.</p>	<i>Ramp stop (Off1)</i>										
	Ramp stop (Off1)	<p>With the drive running:</p> <ul style="list-style-type: none"> 1 = Normal operation. 0 = Normal stop along the standard deceleration ramp defined for the particular reference type. After the drive has stopped, it can be restarted by removing the emergency stop signal and switching the start signal from 0 to 1. <p>With the drive stopped:</p> <ul style="list-style-type: none"> 1 = Starting allowed. 0 = Starting not allowed. 	0										

No.	Name/Value	Description	Def/FbEq16
	Coast stop (Off2)	With the drive running: <ul style="list-style-type: none"> • 1 = Normal operation. • 0 = Stop by coasting. The drive can be restarted by restoring the start interlock signal and switching the start signal from 0 to 1. With the drive stopped: <ul style="list-style-type: none"> • 1 = Starting allowed. • 0 = Starting not allowed. 	1
	Eme ramp stop (Off3)	With the drive running: <ul style="list-style-type: none"> • 1 = Normal operation • 0 = Stop by ramping along emergency stop ramp defined by parameter 23.23 Emergency stop time. After the drive has stopped, it can be restarted by removing the emergency stop signal and switching the start signal from 0 to 1. With the drive stopped: <ul style="list-style-type: none"> • 1 = Starting allowed • 0 = Starting not allowed 	2
21.05	Emergency stop source	Selects the source of the emergency stop signal. The stop mode is selected by parameter 21.04 Emergency stop mode . 0 = Emergency stop active 1 = Normal operation Note: This parameter cannot be changed while the drive is running.	<i>Inactive (true)</i>
	Active (false)	0.	0
	Inactive (true)	1.	1
	Reserved		2
	DI1	Digital input DI1 (10.02 DI delayed status , bit 0).	3
	DI2	Digital input DI2 (10.02 DI delayed status , bit 1).	4
	DI3	Digital input DI3 (10.02 DI delayed status , bit 2).	5
	DI4	Digital input DI4 (10.02 DI delayed status , bit 3).	6
	DI5	Digital input DI5 (10.02 DI delayed status , bit 4).	7
	DI6	Digital input DI6 (10.02 DI delayed status , bit 5).	8
	Other [bit]	Source selection (see Terms and abbreviations on page 285).	-
21.06	Zero speed limit	Defines the zero speed limit. The motor is stopped along a speed ramp (when ramped stop is selected or emergency stop time is used) until the defined zero speed limit is reached. After the zero speed delay, the motor coasts to a stop.	30.00 rpm
	0.00...30000.00 rpm	Zero speed limit.	See par. 46.01

No.	Name/Value	Description	Def/FbEq16
21.07	<i>Zero speed delay</i>	<p>Defines the delay for the zero speed delay function. The function is useful in applications where a smooth and quick restarting is essential. During the delay, the drive knows the rotor position accurately.</p> <p><u>Without zero speed delay:</u> The drive receives a stop command and decelerates along a ramp. When actual motor speed falls below the value of parameter <i>21.06 Zero speed limit</i>, inverter modulation is stopped and the motor coasts to a standstill.</p>  <p><u>With zero speed delay:</u> The drive receives a stop command and decelerates along a ramp. When actual motor speed falls below the value of parameter <i>21.06 Zero speed limit</i>, the zero speed delay function activates. During the delay the function keeps the speed controller live: the inverter modulates, motor is magnetized and the drive is ready for a quick restart.</p> 	0 ms
	0...30000 ms	Zero speed delay.	1 = 1 ms

No.	Name/Value	Description	Def/FbEq16															
21.08	<i>DC current control</i>	<p>Activates/deactivates the DC hold and post-magnetization functions. See section <i>Start methods – DC magnetization</i> (page 150).</p> <p>Note: DC magnetization causes the motor to heat up. In applications where long DC magnetization times are required, externally ventilated motors should be used. If the DC magnetization period is long, DC magnetization cannot prevent the motor shaft from rotating if a constant load is applied to the motor.</p>	0000b															
<table border="1"> <thead> <tr> <th>Bit</th> <th>Name</th> <th>Value</th> </tr> </thead> <tbody> <tr> <td>0</td> <td>DC hold</td> <td> <p>1 = Enable DC hold. See section <i>DC hold</i> (page 151)</p> <p>Note: The DC hold function has no effect if the start signal is switched off.</p> </td> </tr> <tr> <td>1</td> <td>Post magnetization</td> <td> <p>1 = Enable post-magnetization. See section <i>Settings</i> (page 151).</p> <p>Note: Post-magnetization is only available when ramping is the selected stop mode (see parameter <i>21.03 Stop mode</i>).</p> </td> </tr> <tr> <td>2</td> <td>DC brake</td> <td> <p>1 = Enables DC injection braking after modulation has stopped.</p> <p>Notes:</p> <ul style="list-style-type: none"> To enable DC brake, parameter <i>21.03 Stop mode</i> has to be set to <i>Coast</i>. DC braking current can be set with parameter <i>21.10 DC current reference</i>. DC braking time can be set with parameter <i>21.11 Post magnetization time</i>. </td> </tr> <tr> <td>3...15</td> <td>Reserved</td> <td></td> </tr> </tbody> </table>				Bit	Name	Value	0	DC hold	<p>1 = Enable DC hold. See section <i>DC hold</i> (page 151)</p> <p>Note: The DC hold function has no effect if the start signal is switched off.</p>	1	Post magnetization	<p>1 = Enable post-magnetization. See section <i>Settings</i> (page 151).</p> <p>Note: Post-magnetization is only available when ramping is the selected stop mode (see parameter <i>21.03 Stop mode</i>).</p>	2	DC brake	<p>1 = Enables DC injection braking after modulation has stopped.</p> <p>Notes:</p> <ul style="list-style-type: none"> To enable DC brake, parameter <i>21.03 Stop mode</i> has to be set to <i>Coast</i>. DC braking current can be set with parameter <i>21.10 DC current reference</i>. DC braking time can be set with parameter <i>21.11 Post magnetization time</i>. 	3...15	Reserved	
Bit	Name	Value																
0	DC hold	<p>1 = Enable DC hold. See section <i>DC hold</i> (page 151)</p> <p>Note: The DC hold function has no effect if the start signal is switched off.</p>																
1	Post magnetization	<p>1 = Enable post-magnetization. See section <i>Settings</i> (page 151).</p> <p>Note: Post-magnetization is only available when ramping is the selected stop mode (see parameter <i>21.03 Stop mode</i>).</p>																
2	DC brake	<p>1 = Enables DC injection braking after modulation has stopped.</p> <p>Notes:</p> <ul style="list-style-type: none"> To enable DC brake, parameter <i>21.03 Stop mode</i> has to be set to <i>Coast</i>. DC braking current can be set with parameter <i>21.10 DC current reference</i>. DC braking time can be set with parameter <i>21.11 Post magnetization time</i>. 																
3...15	Reserved																	
	0000h...0011h	DC magnetization selection.	1 = 1															
21.09	<i>DC hold speed</i>	Defines the DC hold speed in speed control mode. See parameter <i>21.08 DC current control</i> , and section <i>DC hold</i> (page 151).	5.00 rpm															
	0.00...1000.00 rpm	DC hold speed.	See par. <i>46.01</i>															
21.10	<i>DC current reference</i>	Defines the DC hold current in percent of the motor nominal current. See parameter <i>21.08 DC current control</i> , and section <i>Start methods – DC magnetization</i> (page 150). After 100 s post-magnetization time, the maximum magnetization current is limited to the magnetization current corresponding to the actual flux reference.	30.0%															
	0.0...100.0%	DC hold current.	1 = 1%															
21.11	<i>Post magnetization time</i>	Defines the length of time for which post-magnetization is active after stopping the motor. The magnetization current is defined by parameter <i>21.10 DC current reference</i> . See parameter <i>21.08 DC current control</i> .	0 s															
	0...3000 s	Post-magnetization time.	1 = 1 s															
21.13	<i>Autophasing mode</i>	<p>Selects the way autophasing is performed. See section <i>Autophasing</i> on page 147.</p> <p>Notes:</p> <ul style="list-style-type: none"> This parameter can only be used for PM motors. This parameter cannot be changed while the drive is running. 	<i>Turning</i>															
	Turning	<p>Injects DC current to the motor to align the angle to a known position.</p> <p>Note: The motor may turn when it is started as the shaft is aligned with the remanence flux.</p>	0															

No.	Name/Value	Description	Def/FbEq16
	Turning 2	Rotates the motor to align the angle to a known position. This mode gives the most accurate autophasing result. Note: This mode will cause the motor to rotate.	5
21.14	<i>Pre-heating input source</i>	Selects the source for controlling pre-heating for the motor. The status of the pre-heating is shown as bit 2 of <i>06.21 Drive status word 3</i> . Notes: <ul style="list-style-type: none"> The heating function requires that STO is not triggered. The heating function requires that the drive is not faulted. 	Off
	Off	0. Pre-heating is always deactivated.	0
	On	1. Pre-heating is always activated when the drive is stopped.	1
	DI1	Digital input DI1 (<i>10.02 DI delayed status</i> , bit 0).	2
	DI2	Digital input DI2 (<i>10.02 DI delayed status</i> , bit 1).	3
	DI3	Digital input DI3 (<i>10.02 DI delayed status</i> , bit 2).	4
	DI4	Digital input DI4 (<i>10.02 DI delayed status</i> , bit 3).	5
	DI5	Digital input DI5 (<i>10.02 DI delayed status</i> , bit 4).	6
	DI6	Digital input DI6 (<i>10.02 DI delayed status</i> , bit 5).	7
	Supervision 1	Bit 0 of <i>32.01 Supervision status</i> (see page 403).	8
	Supervision 2	Bit 1 of <i>32.01 Supervision status</i> (see page 403).	9
	Supervision 3	Bit 2 of <i>32.01 Supervision status</i> (see page 403).	10
	Timed function 1	Bit 0 of <i>34.01 Timed functions status</i> (see page 410).	11
	Timed function 2	Bit 1 of <i>34.01 Timed functions status</i> (see page 410).	12
	Timed function 3	Bit 2 of <i>34.01 Timed functions status</i> (see page 410).	13
	MCW user bit 0	Bit 12 of <i>06.01 Main control word</i> (see page 298).	16
	MCW user bit 1	Bit 13 of <i>06.01 Main control word</i> (see page 298).	17
	MCW user bit 2	Bit 14 of <i>06.01 Main control word</i> (see page 298).	18
	MCW user bit 3	Bit 15 of <i>06.01 Main control word</i> (see page 298).	19
	<i>Other [bit]</i>	Source selection (see <i>Terms and abbreviations</i> on page 285).	-
21.15	<i>Pre-heating time delay</i>	Time delay before pre-heating starts after the drive is stopped.	60 s
	10...3000 s	Pre-heating time delay.	1 = 1 s
21.16	<i>Pre-heating current</i>	Defines the DC current used to heat the motor. The value is in percent of the nominal motor current.	0.0%
	0.0...30.0%	Pre-heating current.	1 = 1%



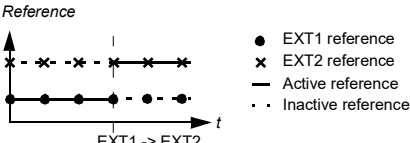

No.	Name/Value	Description	Def/FbEq16
21.18	<i>Auto restart time</i>	<p>The motor can be automatically started after a short supply power failure using the automatic restart function. See section Automatic restart (page 168)</p> <p>When this parameter is set to 0.0 seconds, automatic restarting is disabled. Otherwise, the parameter defines the maximum duration of the power failure after which restarting is attempted. Note that this time also includes the DC precharging delay. See also parameter 21.34 Force auto restart.</p> <p>This parameter has effect only if parameter 95.04 Control board supply is set to External 24V.</p> <p> WARNING! Before you activate the function, make sure that no dangerous situations can occur. The function restarts the drive automatically and continues operation after a supply break.</p>	10.0 s
	0.0 s	Automatic restarting disabled.	0
	0.1...10.0 s	Maximum power failure duration.	10 = 1 s
21.19	<i>Scalar start mode</i>	<p>Selects the motor start function for the scalar motor control mode, ie, when 99.04 Motor control mode is set to Scalar.</p> <p>Notes:</p> <ul style="list-style-type: none"> • The start function for the vector motor control mode is selected by parameter 21.01 Start mode. • With permanent magnet motors, Automatic start mode must be used. • This parameter cannot be changed while the drive is running. <p>See also section Start methods – DC magnetization (page 150).</p>	<i>Normal</i>
	Normal	Immediate start from zero speed.	0
	Const time	<p>The drive pre-magnetizes the motor before start. The pre-magnetizing time is defined by parameter 21.02 Magnetization time. This mode should be selected if constant pre-magnetizing time is required (for example, if the motor start must be synchronized with the release of a mechanical brake). This setting also guarantees the highest possible break-away torque when the pre-magnetizing time is set long enough.</p> <p>Note: This mode cannot be used to start into a rotating motor.</p> <p> WARNING! The drive will start after the set pre-magnetizing time has passed even if motor magnetization is not completed. In applications where a full break-away torque is essential, ensure that the constant magnetizing time is long enough to allow generation of full magnetization and torque.</p>	1
	Automatic	<p>The drive automatically selects the correct output frequency to start a rotating motor. This is useful for flying starts: if the motor is already rotating, the drive will start smoothly at the current frequency.</p> <p>Note: Cannot be used in multimotor systems.</p>	2

No.	Name/Value	Description	Def/FbEq16
	Torque boost	<p>The drive pre-magnetizes the motor before the start. The pre-magnetizing time is defined by parameter 21.02 Magnetization time.</p> <p>Torque boost is applied at start. Torque boost is stopped when output frequency exceeds 40% of nominal frequency or when it is equal to the reference value. See parameter 21.26 Torque boost current.</p> <p>This mode should selected if a high break-away torque is required.</p> <p>Note: This mode cannot be used to start into a rotating motor.</p> <p> WARNING! The drive will start after the set pre-magnetizing time has passed even if motor magnetization is not completed. In applications where a full break-away torque is essential, ensure that the constant magnetizing time is long enough to allow generation of full magnetization and torque.</p>	3
	Automatic+boost	<p>Automatic start with torque boost.</p> <p>Automatic start is performed first and the motor is magnetized. If the speed is found to be zero, torque boost is applied.</p>	4
	Flying start	<p>The drive automatically selects the correct output frequency to start a rotating motor. If the motor is already rotating, drive will start smoothly at the current frequency. – The mode will start the motor with vector control and switch to scalar control on the fly when the motor speed has been found.</p> <p>Compared to the Automatic start mode, Flying start detects the motor speed faster. Flying start requires more accurate information about motor model. Therefore standstill ID run is done automatically when the drive is started for the first time after selecting Flying start. Motor plate values should be accurate. Wrong plate values may decrease the starting performance</p>	5
	Flying start+boost	<p>Flying start with torque boost.</p> <p>Flying start is performed first and the motor is magnetized. If the speed is found to be zero, torque boost is applied.</p>	6
21.21	DC hold frequency	<p>Defines the DC hold frequency, which is used instead of parameter 21.09 DC hold speed when the motor is in scalar frequency mode. See parameter 21.08 DC current control, and section DC hold (page 151).</p>	5.00 Hz
	0.00...1000.00 Hz	DC hold frequency.	1 = 1 Hz
21.22	Start delay	<p>Defines the start delay. After the conditions for start have been fulfilled, the drive waits until the delay has elapsed and then starts the motor. During the delay, warning AFE9 Start delay is shown.</p> <p>Start delay can be used with all start modes.</p>	0.00 s
	0.00...60.00 s	Start delay	1 = 1 s
21.23	Smooth start	<p>Selects the forced current vector rotation mode at low speeds. When the smooth start mode is selected, the rate of acceleration is limited by the acceleration and deceleration ramp times. If the process driven by the permanent magnet synchronous motor has high inertia, slow ramp times are recommended.</p> <p>Can be used for permanent magnet synchronous motors only.</p>	Disabled
	Disabled	Disabled.	0

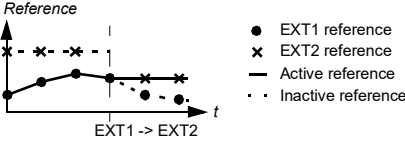
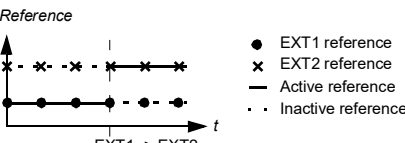
No.	Name/Value	Description	Def/FbEq16
	Enabled always	Enabled always.	1
	Start only	Enabled when starting the motor.	2
21.24	<i>Smooth start current</i>	Current used in the current vector rotation at low speeds. Increase the smooth start current if the application requires motor shaft swinging needs to be minimized. Note that accurate torque control is not possible in the current vector rotation mode. Can be used for permanent magnet synchronous motors only.	50.0%
	10.0...200.0%	Value in percent of the nominal motor current.	1 = 1%
21.25	<i>Smooth start speed</i>	Output frequency up to which the current vector rotation is used. See parameter <i>21.19 Scalar start mode</i> . Can be used for permanent magnet synchronous motors only.	10.0%
	2.0...100.0%	Value as a percentage of the nominal motor frequency.	1 = 1%
21.26	<i>Torque boost current</i>	Defines the maximum supplied current to motor when (<i>21.19 Scalar start mode</i> is set to <i>Torque boost</i> (see page 360). Parameter value is in percent of the motor nominal current. Nominal value of the parameter is 100.0%. Torque boost is only applied at start, ending when output frequency exceeds 40% of nominal frequency or when output frequency is equal to reference. Can be used in scalar mode only.	100.0%
	15.0...300.0%	Value in percent of the nominal motor current.	1 = 1%
21.27	<i>Torque boost time</i>	Defines the minimum and maximum torque boost time. If torque boost time is less than 40% of frequency acceleration time (see parameter <i>28.72</i>), then torque boost time is set at 40% of frequency acceleration time.	20 s
	0.0...60.0 s	Nominal motor time.	1 = 1 s
21.34	<i>Force auto restart</i>	Forces automatic restart. The parameter is applicable only if parameter <i>95.04 Control board supply</i> is set to <i>External 24V</i> .	<i>Enable</i>
	Disable	Force auto restart disabled. Parameter <i>21.18 Auto restart time</i> is in effect if its value is more than 0.0 s.	0
	Enable	Force auto restart enabled. Parameter <i>21.18 Auto restart time</i> is ignored. The drive never trips on the undervoltage fault and the start signal is on forever. When the DC voltage is restored, the normal operation continues.	1
21.35	<i>Preheating power</i>	Defines the power used to heat the motor.	0.00 kW
	0.00 ... 10.00 kW	Preheating power.	100 = 1 kW
21.36	<i>Preheating unit</i>	Defines if preheating is specified as current or power.	<i>Current</i>
	Current	Preheating specified as current.	0
	Power	Preheating specified as power.	1

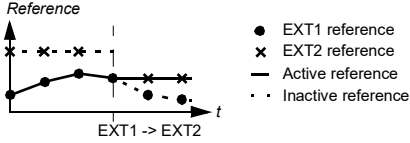
No.	Name/Value	Description	Def/FbEq16
22	Speed reference selection	Speed reference selection; Motor potentiometer settings. See control chain diagrams Speed reference source selection II (page 270)... Speed controller (page 274).	
22.01	<i>Speed ref unlimited</i>	Displays the output of the speed reference selection block. See control chain diagram Speed reference source selection II on page 270. This parameter is read-only.	-
	-30000.00... 30000.00 rpm	Value of the selected speed reference.	See par. 46.01
22.11	<i>Ext1 speed ref1</i>	Selects EXT1 speed reference source 1. A digital source selected by 19.11 Ext1/Ext2 selection can be used to switch between EXT1 reference and the corresponding EXT2 reference defined by parameter 22.18 Ext2 speed ref1 .	<i>A11 scaled</i>
	Zero	None.	0
	AI1 scaled	12.12 AI1 scaled value (see page 321).	1
	AI2 scaled	12.22 AI2 scaled value (see page 323).	2
	Reserved		3
	FB A ref1	03.05 FB A reference 1 (see page 292).	4
	FB A ref2	03.06 FB A reference 2 (see page 292).	5
	Reserved		6...7
	EFB ref1	03.09 EFB reference 1 (see page 293).	8
	EFB ref2	03.10 EFB reference 2 (see page 293).	9
	Reserved		10...14
	Motor potentiometer	22.80 Motor potentiometer ref act (output of the Motor potentiometer).	15
	PID	40.01 Process PID output actual (output of the process PID controller).	16
	Frequency input	11.38 Freq in 1 actual value (when DI5 is used as a frequency input).	17
	Control panel (ref saved)	Control panel reference (03.01 Panel reference , see page 292) saved by the control system for the location where the control returns is used as the reference. 	18

No.	Name/Value	Description	Def/FbEq16
	Control panel (ref copied)	Control panel reference (03.01 Panel reference , see page 292) for the previous control location is used as the reference when the control location changes if the references for the two locations are of the same type (eg frequency/speed/torque/PID); otherwise, the actual signal is used as the new reference. <i>Reference</i>  <ul style="list-style-type: none"> ● EXT1 reference × EXT2 reference — Active reference · · Inactive reference 	19
	Level control	Parameter 76.07 LC speed ref (output of the Level control function).	30
	<i>Other</i>	Source selection (see Terms and abbreviations on page 285).	-
22.18	Ext2 speed ref1	Selects EXT2 speed reference source 1.	Zero
	Zero	None.	0
	AI1 scaled	12.12 AI1 scaled value (see page 321).	1
	AI2 scaled	12.22 AI2 scaled value (see page 323).	2
	Reserved		3
	FB A ref1	03.05 FB A reference 1 (see page 292).	4
	FB A ref2	03.06 FB A reference 2 (see page 292).	5
	Reserved		6...7
	EFB ref1	03.09 EFB reference 1 (see page 293).	8
	EFB ref2	03.10 EFB reference 2 (see page 293).	9
	Reserved		10...14
	Motor potentiometer	22.80 Motor potentiometer ref act (output of the Motor potentiometer).	15
	PID	40.01 Process PID output actual (output of the process PID controller).	16
	Frequency input	11.38 Freq in 1 actual value (when DI5 is used as a frequency input).	17
	Control panel (ref saved)	Control panel reference (03.01 Panel reference , see page 292) saved by the control system for the location where the control returns is used as the reference. <i>Reference</i>  <ul style="list-style-type: none"> ● EXT1 reference × EXT2 reference — Active reference · · Inactive reference 	18

<p>No. Name/Value</p> <p>Control panel (ref copied)</p>	<p>Description</p> <p>Control panel reference (03.01 Panel reference, see page 292) for the previous control location is used as the reference when the control location changes if the references for the two locations are of the same type (eg frequency/speed/torque/PID); otherwise, the actual signal is used as the new reference.</p> 	<p>Def/FbEq16</p> <p>19</p>												
<p>Level control</p>	<p>Parameter 76.07 LC speed ref (output of the Level control function).</p>	<p>30</p>												
<p>Other</p>	<p>Source selection (see Terms and abbreviations on page 285).</p>	<p>-</p>												
<p>22.21 Constant speed function</p>	<p>Determines how constant speeds are selected, and whether the rotation direction signal is considered or not when applying a constant speed.</p>	<p>0000b</p>												
<table border="1"> <thead> <tr> <th data-bbox="162 657 237 683">Bit</th> <th data-bbox="237 657 375 683">Name</th> <th data-bbox="375 657 972 683">Information</th> </tr> </thead> <tbody> <tr> <td data-bbox="162 683 237 826">0</td> <td data-bbox="237 683 375 826">Constant speed mode</td> <td data-bbox="375 683 972 826"> <p>1 = Packed: 7 constant speeds are selectable using the three sources defined by parameters 22.22, 22.23 and 22.24.</p> <p>0 = Separate: Constant speeds 1, 2 and 3 are separately activated by the sources defined by parameters 22.22, 22.23 and 22.24 respectively. In case of conflict, the constant speed with the smaller number takes priority.</p> </td> </tr> <tr> <td data-bbox="162 826 237 1074">1</td> <td data-bbox="237 826 375 1074">Direction enable</td> <td data-bbox="375 826 972 1074"> <p>1 = Start dir: To determine running direction for a constant speed, the sign of the constant speed setting (parameters 22.26...22.32) is multiplied by the direction signal (forward: +1, reverse: -1). This effectively allows the drive to have 14 (7 forward, 7 reverse) constant speeds if all values in 22.26...22.32 are positive.</p> <p> WARNING: If the direction signal is reverse and the active constant speed is negative, the drive will run in the forward direction.</p> <p>0 = According to Par: The running direction for the constant speed is determined by the sign of the constant speed setting (parameters 22.26...22.32).</p> </td> </tr> <tr> <td data-bbox="162 1074 237 1102">2...15</td> <td data-bbox="237 1074 375 1102">Reserved</td> <td data-bbox="375 1074 972 1102"></td> </tr> </tbody> </table>			Bit	Name	Information	0	Constant speed mode	<p>1 = Packed: 7 constant speeds are selectable using the three sources defined by parameters 22.22, 22.23 and 22.24.</p> <p>0 = Separate: Constant speeds 1, 2 and 3 are separately activated by the sources defined by parameters 22.22, 22.23 and 22.24 respectively. In case of conflict, the constant speed with the smaller number takes priority.</p>	1	Direction enable	<p>1 = Start dir: To determine running direction for a constant speed, the sign of the constant speed setting (parameters 22.26...22.32) is multiplied by the direction signal (forward: +1, reverse: -1). This effectively allows the drive to have 14 (7 forward, 7 reverse) constant speeds if all values in 22.26...22.32 are positive.</p> <p> WARNING: If the direction signal is reverse and the active constant speed is negative, the drive will run in the forward direction.</p> <p>0 = According to Par: The running direction for the constant speed is determined by the sign of the constant speed setting (parameters 22.26...22.32).</p>	2...15	Reserved	
Bit	Name	Information												
0	Constant speed mode	<p>1 = Packed: 7 constant speeds are selectable using the three sources defined by parameters 22.22, 22.23 and 22.24.</p> <p>0 = Separate: Constant speeds 1, 2 and 3 are separately activated by the sources defined by parameters 22.22, 22.23 and 22.24 respectively. In case of conflict, the constant speed with the smaller number takes priority.</p>												
1	Direction enable	<p>1 = Start dir: To determine running direction for a constant speed, the sign of the constant speed setting (parameters 22.26...22.32) is multiplied by the direction signal (forward: +1, reverse: -1). This effectively allows the drive to have 14 (7 forward, 7 reverse) constant speeds if all values in 22.26...22.32 are positive.</p> <p> WARNING: If the direction signal is reverse and the active constant speed is negative, the drive will run in the forward direction.</p> <p>0 = According to Par: The running direction for the constant speed is determined by the sign of the constant speed setting (parameters 22.26...22.32).</p>												
2...15	Reserved													
<p>0000h...FFFFh</p>	<p>Constant speed configuration word.</p>	<p>1 = 1</p>												

No.	Name/Value	Description	Def/FbEq16																																				
22.22	<i>Constant speed sel1</i>	When bit 0 of parameter <i>22.21 Constant speed function</i> is 0 (Separate), selects a source that activates constant speed 1. When bit 0 of parameter <i>22.21 Constant speed function</i> is 1 (Packed), this parameter and parameters <i>22.23 Constant speed sel2</i> and <i>22.24 Constant speed sel3</i> select three sources whose states activate constant speeds as follows:	<i>DI3</i>																																				
<table border="1"> <thead> <tr> <th>Source defined by par. 22.22</th> <th>Source defined by par. 22.23</th> <th>Source defined by par. 22.24</th> <th>Constant speed active</th> </tr> </thead> <tbody> <tr> <td>0</td> <td>0</td> <td>0</td> <td>None</td> </tr> <tr> <td>1</td> <td>0</td> <td>0</td> <td>Constant speed 1</td> </tr> <tr> <td>0</td> <td>1</td> <td>0</td> <td>Constant speed 2</td> </tr> <tr> <td>1</td> <td>1</td> <td>0</td> <td>Constant speed 3</td> </tr> <tr> <td>0</td> <td>0</td> <td>1</td> <td>Constant speed 4</td> </tr> <tr> <td>1</td> <td>0</td> <td>1</td> <td>Constant speed 5</td> </tr> <tr> <td>0</td> <td>1</td> <td>1</td> <td>Constant speed 6</td> </tr> <tr> <td>1</td> <td>1</td> <td>1</td> <td>Constant speed 7</td> </tr> </tbody> </table>				Source defined by par. 22.22	Source defined by par. 22.23	Source defined by par. 22.24	Constant speed active	0	0	0	None	1	0	0	Constant speed 1	0	1	0	Constant speed 2	1	1	0	Constant speed 3	0	0	1	Constant speed 4	1	0	1	Constant speed 5	0	1	1	Constant speed 6	1	1	1	Constant speed 7
Source defined by par. 22.22	Source defined by par. 22.23	Source defined by par. 22.24	Constant speed active																																				
0	0	0	None																																				
1	0	0	Constant speed 1																																				
0	1	0	Constant speed 2																																				
1	1	0	Constant speed 3																																				
0	0	1	Constant speed 4																																				
1	0	1	Constant speed 5																																				
0	1	1	Constant speed 6																																				
1	1	1	Constant speed 7																																				
	Always off	0.	0																																				
	Always on	1.	1																																				
	DI1	Digital input DI1 (<i>10.02 DI delayed status</i> , bit 0).	2																																				
	DI2	Digital input DI2 (<i>10.02 DI delayed status</i> , bit 1).	3																																				
	DI3	Digital input DI3 (<i>10.02 DI delayed status</i> , bit 2).	4																																				
	DI4	Digital input DI4 (<i>10.02 DI delayed status</i> , bit 3).	5																																				
	DI5	Digital input DI5 (<i>10.02 DI delayed status</i> , bit 4).	6																																				
	DI6	Digital input DI6 (<i>10.02 DI delayed status</i> , bit 5).	7																																				
	Reserved		8...17																																				
	Timed function 1	Bit 0 of <i>34.01 Timed functions status</i> (see page 410).	18																																				
	Timed function 2	Bit 1 of <i>34.01 Timed functions status</i> (see page 410).	19																																				
	Timed function 3	Bit 2 of <i>34.01 Timed functions status</i> (see page 410).	20																																				
	Reserved		21...23																																				
	Supervision 1	Bit 0 of <i>32.01 Supervision status</i> (see page 403).	24																																				
	Supervision 2	Bit 1 of <i>32.01 Supervision status</i> (see page 403).	25																																				
	Supervision 3	Bit 2 of <i>32.01 Supervision status</i> (see page 403).	26																																				
	<i>Other [bit]</i>	Source selection (see <i>Terms and abbreviations</i> on page 285).	-																																				
22.23	<i>Constant speed sel2</i>	When bit 0 of parameter <i>22.21 Constant speed function</i> is 0 (Separate), selects a source that activates constant speed 2. When bit 0 of parameter <i>22.21 Constant speed function</i> is 1 (Packed), this parameter and parameters <i>22.22 Constant speed sel1</i> and <i>22.24 Constant speed sel3</i> select three sources that are used to activate constant speeds. See table at parameter <i>22.22 Constant speed sel1</i> . For the selections, see parameter <i>22.22 Constant speed sel1</i> .	<i>Always off</i>																																				

No.	Name/Value	Description	Def/FbEq16
22.24	Constant speed sel3	When bit 0 of parameter 22.21 Constant speed function is 0 (Separate), selects a source that activates constant speed 3. When bit 0 of parameter 22.21 Constant speed function is 1 (Packed), this parameter and parameters 22.22 Constant speed sel1 and 22.23 Constant speed sel2 select three sources that are used to activate constant speeds. See table at parameter 22.22 Constant speed sel1 . For the selections, see parameter 22.22 Constant speed sel1 .	<i>Always off</i>
22.25	Constant speed sel4	When bit 0 of parameter 22.21 Constant speed function is 0 (Separate), selects a source that activates constant speed 4. For the selections, see parameter 22.22 Constant speed sel1 .	<i>Always off</i>
22.26	Constant speed 1	Defines constant speed 1 (the speed the motor will turn when constant speed 1 is selected).	300.00 rpm; 360.00 rpm (95.20 b0)
	-30000.00... 30000.00 rpm	Constant speed 1.	See par. 46.01
22.27	Constant speed 2	Defines constant speed 2.	600.00 rpm; 720.00 rpm (95.20 b0)
	-30000.00... 30000.00 rpm	Constant speed 2.	See par. 46.01
22.28	Constant speed 3	Defines constant speed 3.	900.00 rpm; 1080.00 rpm (95.20 b0)
	-30000.00... 30000.00 rpm	Constant speed 3.	See par. 46.01
22.29	Constant speed 4	Defines constant speed 4.	1200.00 rpm; 1440.00 rpm (95.20 b0)
	-30000.00... 30000.00 rpm	Constant speed 4.	See par. 46.01
22.30	Constant speed 5	Defines constant speed 5.	1500.00 rpm; 1800.00 rpm (95.20 b0)
	-30000.00... 30000.00 rpm	Constant speed 5.	See par. 46.01
22.31	Constant speed 6	Defines constant speed 6.	2400.00 rpm; 2880.00 rpm (95.20 b0)
	-30000.00... 30000.00 rpm	Constant speed 6.	See par. 46.01
22.32	Constant speed 7	Defines constant speed 7.	3000.00 rpm; 3600.00 rpm (95.20 b0)
	-30000.00... 30000.00 rpm	Constant speed 7.	See par. 46.01

No.	Name/Value	Description	Def/FbEq16														
22.41	<i>Speed ref safe</i>	Defines a safe speed reference value that is used with supervision functions such as <ul style="list-style-type: none"> • 12.03 AI supervision function • 49.05 Communication loss action • 50.02 FBA A comm loss func • 80.17 Maximum flow protection • 80.18 Minimum flow protection. 	0.00 rpm														
	-30000.00... 30000.00 rpm	Safe speed reference.	See par. 46.01														
22.46	<i>Constant speed sel5</i>	When bit 0 of parameter 22.21 Constant speed function is 0 (Separate), selects a source that activates constant speed 5. For the selections, see parameter 22.22 Constant speed sel1 .	<i>Always off</i>														
22.47	<i>Constant speed sel6</i>	When bit 0 of parameter 22.21 Constant speed function is 0 (Separate), selects a source that activates constant speed 6. For the selections, see parameter 22.22 Constant speed sel1 .	<i>Always off</i>														
22.51	<i>Critical speed function</i>	Enables/disables the critical speeds function. Also determines whether the specified ranges are effective in both rotating directions or not. See also section Critical speeds/frequencies (page 132).	0000b														
<table border="1"> <thead> <tr> <th>Bit</th> <th>Name</th> <th>Information</th> </tr> </thead> <tbody> <tr> <td rowspan="2">0</td> <td rowspan="2">Enable</td> <td>1 = Enable: Critical speeds enabled.</td> </tr> <tr> <td>0 = Disable: Critical speeds disabled.</td> </tr> <tr> <td rowspan="2">1</td> <td rowspan="2">Sign mode</td> <td>1 = Signed: The signs of parameters 22.52...22.57 are taken into account.</td> </tr> <tr> <td>0 = Absolute: Parameters 22.52...22.57 are handled as absolute values. Each range is effective in both directions of rotation.</td> </tr> <tr> <td>2...15</td> <td>Reserved</td> <td></td> </tr> </tbody> </table>				Bit	Name	Information	0	Enable	1 = Enable: Critical speeds enabled.	0 = Disable: Critical speeds disabled.	1	Sign mode	1 = Signed: The signs of parameters 22.52...22.57 are taken into account.	0 = Absolute: Parameters 22.52...22.57 are handled as absolute values. Each range is effective in both directions of rotation.	2...15	Reserved	
Bit	Name	Information															
0	Enable	1 = Enable: Critical speeds enabled.															
		0 = Disable: Critical speeds disabled.															
1	Sign mode	1 = Signed: The signs of parameters 22.52...22.57 are taken into account.															
		0 = Absolute: Parameters 22.52...22.57 are handled as absolute values. Each range is effective in both directions of rotation.															
2...15	Reserved																
	0000h...FFFFh	Critical speeds configuration word.	1 = 1														
22.52	<i>Critical speed 1 low</i>	Defines the low limit for critical speed range 1. Note: This value must be less than or equal to the value of 22.53 Critical speed 1 high .	0.00 rpm														
	-30000.00... 30000.00 rpm	Low limit for critical speed 1.	See par. 46.01														
22.53	<i>Critical speed 1 high</i>	Defines the high limit for critical speed range 1. Note: This value must be greater than or equal to the value of 22.52 Critical speed 1 low .	0.00 rpm														
	-30000.00... 30000.00 rpm	High limit for critical speed 1.	See par. 46.01														
22.54	<i>Critical speed 2 low</i>	Defines the low limit for critical speed range 2. Note: This value must be less than or equal to the value of 22.55 Critical speed 2 high .	0.00 rpm														
	-30000.00... 30000.00 rpm	Low limit for critical speed 2.	See par. 46.01														
22.55	<i>Critical speed 2 high</i>	Defines the high limit for critical speed range 2. Note: This value must be greater than or equal to the value of 22.54 Critical speed 2 low .	0.00 rpm														
	-30000.00... 30000.00 rpm	High limit for critical speed 2.	See par. 46.01														

No.	Name/Value	Description	Def/FbEq16
22.56	<i>Critical speed 3 low</i>	Defines the low limit for critical speed range 3. Note: This value must be less than or equal to the value of 22.57 Critical speed 3 high .	0.00 rpm
	-30000.00... 30000.00 rpm	Low limit for critical speed 3.	See par. 46.01
22.57	<i>Critical speed 3 high</i>	Defines the high limit for critical speed range 3. Note: This value must be greater than or equal to the value of 22.56 Critical speed 3 low .	0.00 rpm
	-30000.00... 30000.00 rpm	High limit for critical speed 3.	See par. 46.01
22.71	<i>Motor potentiometer function</i>	Activates and selects the mode of the Motor potentiometer.	<i>Disabled</i>
	Disabled	Motor potentiometer is disabled and the Motor potentiometer counter value set to 0.	0
	Enabled (init at stop /power-up)	When enabled, the Motor potentiometer counter first adopts the value defined by parameter 22.72 Motor potentiometer initial value . The value can then be adjusted from the up and down sources defined by parameters 22.73 Motor potentiometer up source and 22.74 Motor potentiometer down source . A stop or a power cycle will reset the counter to the initial value (22.72).	1
	Enabled (resume always)	As <i>Enabled (init at stop /power-up)</i> , but the Motor potentiometer counter is retained over a power cycle.	2
	Enabled (init to actual)	Whenever another reference source is selected, the value of the Motor potentiometer counter follows that reference. After the source of reference returns to the Motor potentiometer counter, its value can again be changed by the up and down sources (defined by 22.73 and 22.74).	3
	<u>Enabled (resume/init to Actual)</u>	<u>As <i>Enabled (init to actual)</i>, but the motor potentiometer ref act value is retained over power cycle.</u>	4
22.72	<i>Motor potentiometer initial value</i>	Defines an initial value (starting point) for the Motor potentiometer counter. See the selections of parameter 22.71 Motor potentiometer function .	0.00
	-32768.00... 32767.00	Initial value for the counter.	1 = 1
22.73	<i>Motor potentiometer up source</i>	Selects the source of Motor potentiometer counter up signal. 0 = No change 1 = Increase Motor potentiometer counter value. (If both the up and down sources are on, the potentiometer value will not change.) Note: Motor potentiometer function up/down source control speed or frequency from zero to maximum speed or frequency. The running direction can be changed with parameter 20.04 Ext1 in2 source . See the figure in section Motor potentiometer on page 162.	<i>Not used</i>
	Not used	0.	0
	Not used	1.	1
	DI1	Digital input DI1 (10.02 DI delayed status , bit 0).	2

No.	Name/Value	Description	Def/FbEq16
	DI2	Digital input DI2 (<i>10.02 DI delayed status</i> , bit 1).	3
	DI3	Digital input DI3 (<i>10.02 DI delayed status</i> , bit 2).	4
	DI4	Digital input DI4 (<i>10.02 DI delayed status</i> , bit 3).	5
	DI5	Digital input DI5 (<i>10.02 DI delayed status</i> , bit 4).	6
	DI6	Digital input DI6 (<i>10.02 DI delayed status</i> , bit 5).	7
	Reserved		8...17
	Timed function 1	Bit 0 of <i>34.01 Timed functions status</i> (see page 410).	18
	Timed function 2	Bit 1 of <i>34.01 Timed functions status</i> (see page 410).	19
	Timed function 3	Bit 2 of <i>34.01 Timed functions status</i> (see page 410).	20
	Reserved		21...23
	Supervision 1	Bit 0 of <i>32.01 Supervision status</i> (see page 403).	24
	Supervision 2	Bit 1 of <i>32.01 Supervision status</i> (see page 403).	25
	Supervision 3	Bit 2 of <i>32.01 Supervision status</i> (see page 403).	26
	<i>Other [bit]</i>	Source selection (see <i>Terms and abbreviations</i> on page 285).	-
<i>22.74</i>	<i>Motor potentiometer down source</i>	Selects the source of Motor potentiometer counter down signal. 0 = No change 1 = Decrease Motor potentiometer counter value. (If both the up and down sources are on, the counter value will not change.) Note: Motor potentiometer function up/down source control speed or frequency from zero to maximum speed or frequency. The running direction can be changed with parameter <i>20.04 Ext1 in2 source</i> . See the figure in section <i>Motor potentiometer</i> on page 162. For the selections, see parameter <i>22.73 Motor potentiometer up source</i> .	<i>Not used</i>
<i>22.75</i>	<i>Motor potentiometer ramp time</i>	Defines the change rate of the Motor potentiometer counter. This parameter specifies the time required for the Motor potentiometer to change from minimum (<i>22.76</i>) to maximum (<i>22.77</i>). The same change rate applies in both directions.	40.0 s
	0.0...3600.0 s	Counter change time.	1 = 1 s
<i>22.76</i>	<i>Motor potentiometer min value</i>	Defines the minimum value of the Motor potentiometer counter. Note: If vector control mode is used, value of this parameter must be changed.	-50.00
	-32768.00... 32767.00	Counter minimum.	1 = 1
<i>22.77</i>	<i>Motor potentiometer max value</i>	Defines the maximum value of the Motor potentiometer counter. Note: If vector control mode is used, value of this parameter must be changed.	50.00
	-32768.00... 32767.00	Counter maximum.	1 = 1
<i>22.80</i>	<i>Motor potentiometer ref act</i>	The output of the Motor potentiometer function. (The meter is configured using parameters <i>22.71...22.74</i> .) This parameter is read-only.	-
	-32768.00... 32767.00	Value of the Motor potentiometer counter.	1 = 1

No.	Name/Value	Description	Def/FbEq16
22.86	<i>Speed reference act 6</i>	Displays the value of the speed reference (EXT1 or EXT2) that has been selected by 19.11 Ext1/Ext2 selection . See diagram at 22.11 Ext1 speed ref1 or control chain diagram Speed reference source selection II on page 270. This parameter is read-only.	-
	-30000.00... 30000.00 rpm	Speed reference after additive 2.	See par. 46.01
22.87	<i>Speed reference act 7</i>	Displays the value of speed reference before application of critical speeds. See the control chain diagram on page 270. The value is received from 22.86 Speed reference act 6 unless overridden by <ul style="list-style-type: none"> any constant speed network control reference (see page 19) control panel reference safe speed reference. This parameter is read-only.	-
	-30000.00... 30000.00 rpm	Speed reference before application of critical speeds.	See par. 46.01
23 Speed reference ramp		Speed reference ramp settings (programming of the acceleration and deceleration rates for the drive). See control chain diagram Speed reference source selection II on page 270.	
23.01	<i>Speed ref ramp input</i>	Displays the used speed reference (in rpm) before it enters the ramping and shaping functions. See control chain diagram Speed reference source selection II on page 270. This parameter is read-only.	-
	-30000.00... 30000.00 rpm	Speed reference before ramping and shaping.	See par. 46.01
23.02	<i>Speed ref ramp output</i>	Displays the ramped and shaped speed reference in rpm. See control chain diagram Speed reference source selection II on page 270. This parameter is read-only.	-
	-30000.00... 30000.00 rpm	Speed reference after ramping and shaping.	See par. 46.01
23.12	<i>Acceleration time 1</i>	Defines acceleration time 1 as the time required for the speed to change from zero to the speed defined by parameter 46.01 Speed scaling (not to parameter 30.12 Maximum speed). If the speed reference increases faster than the set acceleration rate, the motor speed will follow the acceleration rate. If the speed reference increases slower than the set acceleration rate, the motor speed will follow the reference. If the acceleration time is set too short, the drive will automatically prolong the acceleration in order not to exceed the drive torque limits.	5.000 s
	0.000...1800.000 s	Acceleration time 1.	10 = 1 s

No.	Name/Value	Description	Def/FbEq16
23.13	<i>Deceleration time 1</i>	Defines deceleration time 1 as the time required for the speed to change from the speed defined by parameter 46.01 Speed scaling (not from parameter 30.12 Maximum speed) to zero. If the speed reference decreases slower than the set deceleration rate, the motor speed will follow the reference. If the reference changes faster than the set deceleration rate, the motor speed will follow the deceleration rate. If the deceleration rate is set too short, the drive will automatically prolong the deceleration in order not to exceed drive torque limits (or not to exceed a safe DC link voltage). If there is any doubt about the deceleration time being too short, ensure that DC overvoltage control is on (parameter 30.30 Overvoltage control). Note: If a short deceleration time is needed for a high inertia application, the drive should be equipped with braking equipment such as a brake chopper and brake resistor.	5.000 s
	0.000...1800.000 s	Deceleration time 1.	10 = 1 s
23.23	<i>Emergency stop time</i>	Defines the time inside which the drive is stopped if an emergency stop Off3 is activated (ie. the time required for the speed to change from the speed value defined by parameter 46.01 Speed scaling or 46.02 Frequency scaling to zero). Emergency stop mode and activation source are selected by parameters 21.04 Emergency stop mode and 21.05 Emergency stop source respectively. Emergency stop can also be activated through fieldbus. Notes: <ul style="list-style-type: none">Emergency stop Off1 uses the standard deceleration ramp as defined by parameters 23.12...23.13.The same parameter value is also used in frequency control mode (ramp parameters 28.72...28.73).	3.000 s
	0.000...1800.000 s	Emergency stop Off3 deceleration time.	10 = 1 s
23.32	<i>Shape time 1</i>	Defines the shape of acceleration ramp at the beginning of acceleration.	0.000 s
	0.000...1800.000 s	Shape time 1.	10 = 1 s
24 Speed reference conditioning		Speed error calculation; speed error window control configuration; speed error step. See control chain diagram Speed error calculation on page 272 .	
24.01	<i>Used speed reference</i>	Displays the ramped and corrected speed reference (before speed error calculation). See control chain diagram Speed error calculation on page 272 . This parameter is read-only.	-
	-30000.00... 30000.00 rpm	Speed reference used for speed error calculation.	See par. 46.01
24.02	<i>Used speed feedback</i>	Displays the speed feedback used for speed error calculation. See control chain diagram Speed error calculation on page 272 . This parameter is read-only.	-
	-30000.00... 30000.00 rpm	Speed feedback used for speed error calculation.	See par. 46.01

No.	Name/Value	Description	Def/FbEq16
24.03	<i>Speed error filtered</i>	Displays the filtered speed error. See control chain diagram Speed error calculation on page 272. This parameter is read-only.	-
	-30000.00... 30000.00 rpm	Filtered speed error.	See par. 46.01
24.04	<i>Speed error inverted</i>	Displays the inverted (unfiltered) speed error. See control chain diagram Speed error calculation on page 272. This parameter is read-only.	-
	-30000.0... 30000.0 rpm	Inverted speed error.	See par. 46.01
24.11	<i>Speed correction</i>	Defines a speed reference correction, ie, a value added to the existing reference between ramping and limitation. This is useful to trim the speed if necessary, for example, to adjust draw between sections of a paper machine. See control chain diagram Speed error calculation on page 272.	0.00 rpm
	-10000.00... 10000.00 rpm	Speed reference correction.	See par. 46.01
24.12	<i>Speed error filter time</i>	Defines the time constant of the speed error low-pass filter. If the used speed reference changes rapidly, the possible interferences in the speed measurement can be filtered with the speed error filter. Reducing the ripple with this filter may cause speed controller tuning problems. A long filter time constant and fast acceleration time contradict one another. A very long filter time results in unstable control.	0 ms
	0...10000 ms	Speed error filtering time constant. 0 = filtering disabled.	1 = 1 ms
25 Speed control		Speed controller settings. See control chain diagram Speed error calculation on page 272.	
25.01	<i>Torque reference speed control</i>	Displays the speed controller output that is transferred to the torque controller. See control chain diagram Speed error calculation on page 272. This parameter is read-only.	-
	-1600.0...1600.0%	Limited speed controller output torque.	See par. 46.03

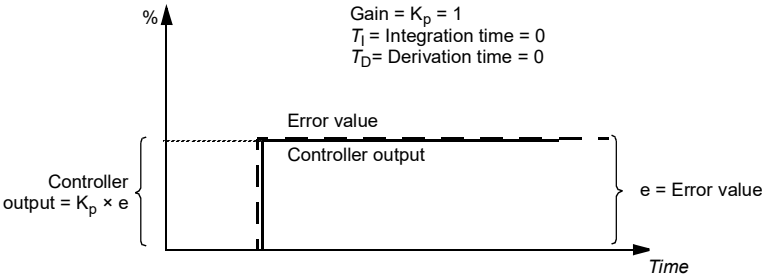
No.	Name/Value	Description	Def/FbEq16
25.02	<i>Speed proportional gain</i>	<p>Defines the proportional gain (K_p) of the speed controller. Too high a gain may cause speed oscillation. The figure below shows the speed controller output after an error step when the error remains constant.</p>  <p>Gain = $K_p = 1$ T_I = Integration time = 0 T_D = Derivation time = 0</p> <p>Controller output = $K_p \times e$</p> <p>e = Error value</p> <p>If gain is set to 1, a 10% change in error value (reference - actual value) causes the speed controller output to change by 10%, ie, the output value is input \times gain.</p>	5.00
0.00...250.00		Proportional gain for speed controller.	100 = 1

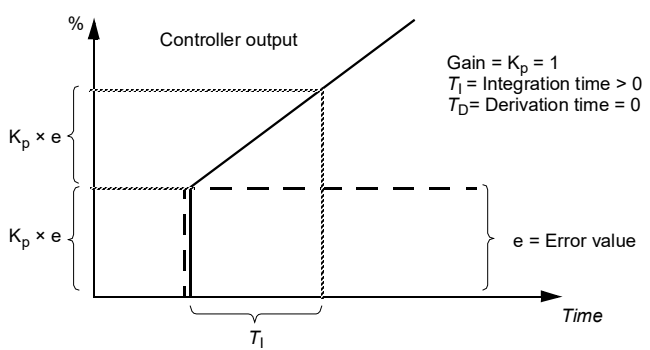

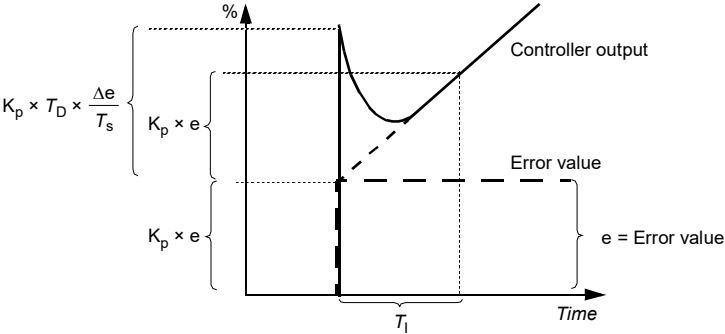

No.	Name/Value	Description	Def/FbEq16
25.03	<i>Speed integration time</i>	<p>Defines the integration time of the speed controller. The integration time defines the rate at which the controller output changes when the error value is constant and the proportional gain of the speed controller is 1. The shorter the integration time, the faster the continuous error value is corrected. This time constant must be set to the same order of magnitude as the time constant (time to respond) of the actual mechanical system being controlled, otherwise instability will result.</p> <p>Setting the integration time to zero disables the I-part of the controller. This is useful to do when tuning the proportional gain; adjust the proportional gain first, then return the integration time.</p> <p>Anti-windup (the integrator just integrates up to 100%) stops the integrator if the controller output is limited.</p> <p>The figure below shows the speed controller output after an error step when the error remains constant.</p> 	2.50 s
0.00...1000.00 s		Integration time for speed controller.	10 = 1 s

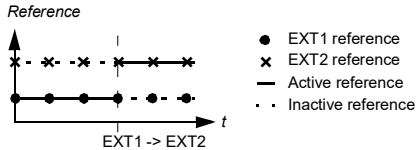
No.	Name/Value	Description	Def/FbEq16
25.04	<i>Speed derivation time</i>	<p>Defines the derivation time of the speed controller. Derivative action boosts the controller output if the error value changes. The longer the derivation time, the more the speed controller output is boosted during the change. If the derivation time is set to zero, the controller works as a PI controller, otherwise as a PID controller. The derivation makes the control more responsive for disturbances. For simple applications, derivative time is not normally required and should be left at zero.</p> <p>The speed error derivative must be filtered with a low pass filter to eliminate disturbances.</p> <p>The figure below shows the speed controller output after an error step when the error remains constant.</p>  <p>Gain = $K_p = 1$ $T_I =$ Integration time > 0 $T_D =$ Derivation time > 0 $T_s =$ Sample time period = 250 μs $\Delta e =$ Error value change between two samples</p>	0.000 s
	0.000...10.000 s	Derivation time for speed controller.	1000 = 1 s
25.05	<i>Derivation filter time</i>	Defines the derivation filter time constant. See parameter 25.04 Speed derivation time .	8 ms
	0...10000 ms	Derivation filter time constant.	1 = 1 ms
25.15	<i>Proportional gain em stop</i>	Defines the proportional gain for the speed controller when an emergency stop is active. See parameter 25.02 Speed proportional gain .	10.00
	1.00...250.00	Proportional gain upon an emergency stop.	100 = 1
25.33	<i>Speed controller auto tune</i>	Activates (or selects a source that activates) the speed controller auto tune function. See section Before activating the autotune routine on page 164.	Off
	Off	Not activated.	0
	On	Activated.	1
25.34	<i>Auto tune control preset</i>	Defines a control preset for the speed controller auto tune function. The setting affects the way the torque reference will respond to a speed reference step.	Normal
	Smooth	Slow yet robust response.	0
	Normal	Normal response.	1

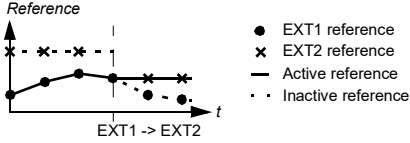
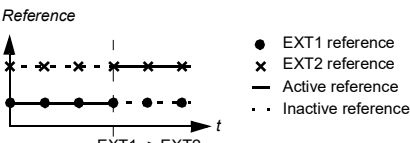
No.	Name/Value	Description	Def/FbEq16
	Tight	Fast response which can produce high gain value.	2
25.37	<i>Mechanical time constant</i>	Mechanical time constant of the drive and the machinery as determined by the speed controller autotune function. The value can be adjusted manually.	0.00 s
	0.00 ... 1000.00 s	Mechanical time constant.	10 = 1 s
25.38	<i>Auto tune torque step</i>	Defines an added torque value used by the auto tune function. This value is scaled to the motor nominal torque. Note: The torque used by the auto tune function can also be limited by the torque limits (in parameter group 30 Limits) and the nominal motor torque.	10.00%
	0.00 ... 20.00%	Torque step.	100 = 1%
25.39	<i>Auto tune speed step</i>	Defines a speed value added to the initial speed for the auto tune function. The initial speed (speed used when auto tune is activated) plus the value of this parameter is the calculated maximum speed used by the auto tune routine. The maximum speed can also be limited by the speed limits (in parameter group 30 Limits) and nominal motor speed. The value is scaled to the motor nominal speed. Note: The motor will exceed the calculated maximum speed slightly at the end of each acceleration stage.	10.00%
	0.00 ... 20.00%	Speed step.	100 = 1%
25.40	<i>Auto tune repeat times</i>	Determines how many acceleration/deceleration cycles are performed during the auto tune routine. Increasing the value will improve the accuracy of the auto tune function, and allow the use of smaller torque or speed step values	5
	0 ... 10	Number of steps for auto tune.	1 = 1
25.53	<i>Torque prop reference</i>	Displays the output of the proportional (P) part of the speed controller. See control chain diagram Speed error calculation on page 272 . This parameter is read-only.	-
	-30000.0... 30000.0%	P-part output of speed controller.	See par. 46.03
25.54	<i>Torque integral reference</i>	Displays the output of the integral (I) part of the speed controller. See control chain diagram Speed error calculation on page 272 . This parameter is read-only.	-
	-30000.0... 30000.0%	I-part output of speed controller.	See par. 46.03
25.55	<i>Torque deriv reference</i>	Displays the output of the derivative (D) part of the speed controller. See control chain diagram Speed error calculation on page 272 . This parameter is read-only.	-
	-30000.0... 30000.0%	D-part output of speed controller.	See par. 46.03

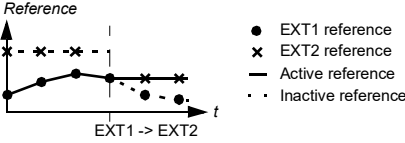
No.	Name/Value	Description	Def/FbEq16
28 Frequency reference chain		Settings for the frequency reference chain. See the control chain diagrams on pages 268 and 269.	
28.01	<i>Frequency ref ramp input</i>	Displays the used frequency reference before ramping. See the control chain diagrams <i>Frequency reference selection</i> on page 268 and <i>Frequency reference modification</i> on page 269. This parameter is read-only.	-
	-500.00...500.00 Hz	Frequency reference before ramping.	See par. 46.02
28.02	<i>Frequency ref ramp output</i>	Displays the final frequency reference (after selection, limitation and ramping). See control chain diagram on page 268. This parameter is read-only.	-
	-500.00...500.00 Hz	Final frequency reference.	See par. 46.02
28.11	<i>Ext1 frequency ref1</i>	Selects EXT1 frequency reference source 1.	<i>A11 scaled</i>
	Zero	None.	0
	A11 scaled	<i>12.12 A11 scaled value</i> (see page 321).	1
	A12 scaled	<i>12.22 A12 scaled value</i> (see page 323).	2
	Reserved		3
	FB A ref1	<i>03.05 FB A reference 1</i> (see page 292).	4
	FB A ref2	<i>03.06 FB A reference 2</i> (see page 292).	5
	Reserved		6...7
	EFB ref1	<i>03.09 EFB reference 1</i> (see page 293).	8
	EFB ref2	<i>03.10 EFB reference 2</i> (see page 293).	9
	Reserved		10...14
	Motor potentiometer	<i>22.80 Motor potentiometer ref act</i> (output of the Motor potentiometer).	15
	PID	<i>40.01 Process PID output actual</i> (output of the process PID controller).	16
	Frequency input	<i>11.38 Freq in 1 actual value</i> (when DI5 is used as a frequency input).	17
	Control panel (ref saved)	Control panel reference (<i>03.01 Panel reference</i> , see page 292) saved by the control system for the location where the control returns is used as the reference.  <p>The diagram shows a reference signal over time (t). It starts with an active reference (solid line) from EXT1. At a certain point, it switches to an active reference (solid line) from EXT2. Inactive references (dashed lines) are shown for both EXT1 and EXT2 during the transition. A legend indicates: ● EXT1 reference, × EXT2 reference, — Active reference, ··· Inactive reference.</p>	18

No.	Name/Value	Description	Def/FbEq16
	Control panel (ref copied)	Control panel reference (03.01 Panel reference , see page 292) for the previous control location is used as the reference when the control location changes if the references for the two locations are of the same type (eg frequency/speed/torque/PID); otherwise, the actual signal is used as the new reference. 	19
	Level control	Parameter 76.07 LC speed ref (output of the Level control function).	30
	<i>Other</i>	Source selection (see Terms and abbreviations on page 285).	-
28.15	<i>Ext2 frequency ref1</i>	Selects EXT2 frequency reference source 1.	<i>Zero</i>
	Zero	None.	0
	AI1 scaled	12.12 AI1 scaled value (see page 321).	1
	AI2 scaled	12.22 AI2 scaled value (see page 323).	2
	Reserved		3
	FB A ref1	03.05 FB A reference 1 (see page 292).	4
	FB A ref2	03.06 FB A reference 2 (see page 292).	5
	Reserved		6...7
	EFB ref1	03.09 EFB reference 1 (see page 293).	8
	EFB ref2	03.10 EFB reference 2 (see page 293).	9
	Reserved		10...14
	Motor potentiometer	22.80 Motor potentiometer ref act (output of the Motor potentiometer).	15
	PID	40.01 Process PID output actual (output of the process PID controller).	16
	Frequency input	11.38 Freq in 1 actual value (when DI5 is used as a frequency input).	17
	Control panel (ref saved)	Control panel reference (03.01 Panel reference , see page 292) saved by the control system for the location where the control returns is used as the reference. 	18

No.	Name/Value	Description	Def/FbEq16												
	Control panel (ref copied)	Control panel reference (03.01 Panel reference , see page 292) for the previous control location is used as the reference when the control location changes if the references for the two locations are of the same type (eg frequency/speed/torque/PID); otherwise, the actual signal is used as the new reference.  <p style="text-align: center;">Reference</p> <p style="text-align: center;">EXT1 -> EXT2</p> <ul style="list-style-type: none"> ● EXT1 reference × EXT2 reference — Active reference · · Inactive reference 	19												
	Level control	Parameter 76.07 LC speed ref (output of the Level control function).	30												
	<i>Other</i>	Source selection (see Terms and abbreviations on page 285).	-												
28.21	Constant frequency function	Determines how constant frequencies are selected, and whether the rotation direction signal is considered or not when applying a constant frequency.	0000b												
		<table border="1" style="width: 100%; border-collapse: collapse;"> <thead> <tr> <th>Bit</th> <th>Name</th> <th>Information</th> </tr> </thead> <tbody> <tr> <td>0</td> <td>Const freq mode</td> <td> <p>1 = Packed: 7 constant frequencies are selectable using the three sources defined by parameters 28.22, 28.23 and 28.24.</p> <p>0 = Separate: Constant frequencies 1, 2 and 3 are separately activated by the sources defined by parameters 28.22, 28.23 and 28.24 respectively. In case of conflict, the constant frequency with the smaller number takes priority.</p> </td> </tr> <tr> <td>1</td> <td>Direction enable</td> <td> <p>1 = Start dir: To determine running direction for a constant speed, the sign of the constant speed setting (parameters 22.26...22.32) is multiplied by the direction signal (forward: +1, reverse: -1). This effectively allows the drive to have 14 (7 forward, 7 reverse) constant speeds if all values in 22.26...22.32 are positive.</p> <p> WARNING: If the direction signal is reverse and the active constant speed is negative, the drive will run in the forward direction.</p> <p>0 = According to Par: The running direction for the constant speed is determined by the sign of the constant speed setting (parameters 22.26...22.32).</p> </td> </tr> <tr> <td>2...15</td> <td>Reserved</td> <td></td> </tr> </tbody> </table>	Bit	Name	Information	0	Const freq mode	<p>1 = Packed: 7 constant frequencies are selectable using the three sources defined by parameters 28.22, 28.23 and 28.24.</p> <p>0 = Separate: Constant frequencies 1, 2 and 3 are separately activated by the sources defined by parameters 28.22, 28.23 and 28.24 respectively. In case of conflict, the constant frequency with the smaller number takes priority.</p>	1	Direction enable	<p>1 = Start dir: To determine running direction for a constant speed, the sign of the constant speed setting (parameters 22.26...22.32) is multiplied by the direction signal (forward: +1, reverse: -1). This effectively allows the drive to have 14 (7 forward, 7 reverse) constant speeds if all values in 22.26...22.32 are positive.</p> <p> WARNING: If the direction signal is reverse and the active constant speed is negative, the drive will run in the forward direction.</p> <p>0 = According to Par: The running direction for the constant speed is determined by the sign of the constant speed setting (parameters 22.26...22.32).</p>	2...15	Reserved		
Bit	Name	Information													
0	Const freq mode	<p>1 = Packed: 7 constant frequencies are selectable using the three sources defined by parameters 28.22, 28.23 and 28.24.</p> <p>0 = Separate: Constant frequencies 1, 2 and 3 are separately activated by the sources defined by parameters 28.22, 28.23 and 28.24 respectively. In case of conflict, the constant frequency with the smaller number takes priority.</p>													
1	Direction enable	<p>1 = Start dir: To determine running direction for a constant speed, the sign of the constant speed setting (parameters 22.26...22.32) is multiplied by the direction signal (forward: +1, reverse: -1). This effectively allows the drive to have 14 (7 forward, 7 reverse) constant speeds if all values in 22.26...22.32 are positive.</p> <p> WARNING: If the direction signal is reverse and the active constant speed is negative, the drive will run in the forward direction.</p> <p>0 = According to Par: The running direction for the constant speed is determined by the sign of the constant speed setting (parameters 22.26...22.32).</p>													
2...15	Reserved														
	0000h...FFFFh	Constant frequency configuration word.	1 = 1												

No.	Name/Value	Description	Def/FbEq16																																				
28.22	<i>Constant frequency sel1</i>	When bit 0 of parameter 28.21 Constant frequency function is 0 (Separate), selects a source that activates constant frequency 1. When bit 0 of parameter 28.21 Constant frequency function is 1 (Packed), this parameter and parameters 28.23 Constant frequency sel2 and 28.24 Constant frequency sel3 select three sources whose states activate constant frequencies as follows:	<i>DI3</i>																																				
<table border="1"> <thead> <tr> <th>Source defined by par. 28.22</th> <th>Source defined by par. 28.23</th> <th>Source defined by par. 28.24</th> <th>Constant frequency active</th> </tr> </thead> <tbody> <tr> <td>0</td> <td>0</td> <td>0</td> <td>None</td> </tr> <tr> <td>1</td> <td>0</td> <td>0</td> <td>Constant frequency 1</td> </tr> <tr> <td>0</td> <td>1</td> <td>0</td> <td>Constant frequency 2</td> </tr> <tr> <td>1</td> <td>1</td> <td>0</td> <td>Constant frequency 3</td> </tr> <tr> <td>0</td> <td>0</td> <td>1</td> <td>Constant frequency 4</td> </tr> <tr> <td>1</td> <td>0</td> <td>1</td> <td>Constant frequency 5</td> </tr> <tr> <td>0</td> <td>1</td> <td>1</td> <td>Constant frequency 6</td> </tr> <tr> <td>1</td> <td>1</td> <td>1</td> <td>Constant frequency 7</td> </tr> </tbody> </table>				Source defined by par. 28.22	Source defined by par. 28.23	Source defined by par. 28.24	Constant frequency active	0	0	0	None	1	0	0	Constant frequency 1	0	1	0	Constant frequency 2	1	1	0	Constant frequency 3	0	0	1	Constant frequency 4	1	0	1	Constant frequency 5	0	1	1	Constant frequency 6	1	1	1	Constant frequency 7
Source defined by par. 28.22	Source defined by par. 28.23	Source defined by par. 28.24	Constant frequency active																																				
0	0	0	None																																				
1	0	0	Constant frequency 1																																				
0	1	0	Constant frequency 2																																				
1	1	0	Constant frequency 3																																				
0	0	1	Constant frequency 4																																				
1	0	1	Constant frequency 5																																				
0	1	1	Constant frequency 6																																				
1	1	1	Constant frequency 7																																				
	Always off	0.	0																																				
	Always on	1.	1																																				
	DI1	Digital input DI1 (10.02 DI delayed status , bit 0).	2																																				
	DI2	Digital input DI2 (10.02 DI delayed status , bit 1).	3																																				
	DI3	Digital input DI3 (10.02 DI delayed status , bit 2).	4																																				
	DI4	Digital input DI4 (10.02 DI delayed status , bit 3).	5																																				
	DI5	Digital input DI5 (10.02 DI delayed status , bit 4).	6																																				
	DI6	Digital input DI6 (10.02 DI delayed status , bit 5).	7																																				
	Reserved		8...17																																				
	Timed function 1	Bit 0 of 34.01 Timed functions status (see page 410).	18																																				
	Timed function 2	Bit 1 of 34.01 Timed functions status (see page 410).	19																																				
	Timed function 3	Bit 2 of 34.01 Timed functions status (see page 410).	20																																				
	Reserved		21...23																																				
	Supervision 1	Bit 0 of 32.01 Supervision status (see page 403).	24																																				
	Supervision 2	Bit 1 of 32.01 Supervision status (see page 403).	25																																				
	Supervision 3	Bit 2 of 32.01 Supervision status (see page 403).	26																																				
	<i>Other [bit]</i>	Source selection (see Terms and abbreviations on page 285).	-																																				
28.23	<i>Constant frequency sel2</i>	When bit 0 of parameter 28.21 Constant frequency function is 0 (Separate), selects a source that activates constant frequency 2. When bit 0 of parameter 28.21 Constant frequency function is 1 (Packed), this parameter and parameters 28.22 Constant frequency sel1 and 28.24 Constant frequency sel3 select three sources that are used to activate constant frequencies. See table at parameter 28.22 Constant frequency sel1 . For the selections, see parameter 28.22 Constant frequency sel1 .	<i>Always off</i>																																				

No.	Name/Value	Description	Def/FbEq16
28.24	<i>Constant frequency sel3</i>	When bit 0 of parameter <i>28.21 Constant frequency function</i> is 0 (Separate), selects a source that activates constant frequency 3. When bit 0 of parameter <i>28.21 Constant frequency function</i> is 1 (Packed), this parameter and parameters <i>28.22 Constant frequency sel1</i> and <i>28.23 Constant frequency sel2</i> select three sources that are used to activate constant frequencies. See table at parameter <i>28.22 Constant frequency sel1</i> . For the selections, see parameter <i>28.22 Constant frequency sel1</i> .	<i>Always off</i>
28.25	<i>Constant frequency sel4</i>	When bit 0 of parameter <i>28.21 Constant frequency function</i> is 0 (Separate), selects a source that activates constant frequency 4. For the selections, see parameter <i>28.22 Constant frequency sel1</i> .	<i>Always off</i>
28.26	<i>Constant frequency 1</i>	Defines constant frequency 1 (the frequency the motor will turn when constant frequency 1 is selected).	5.00 Hz; 6.00 Hz (95.20 b0)
	-500.00...500.00 Hz	Constant frequency 1.	See par. 46.02
28.27	<i>Constant frequency 2</i>	Defines constant frequency 2.	10.00 Hz; 12.00 Hz (95.20 b0)
	-500.00...500.00 Hz	Constant frequency 2.	See par. 46.02
28.28	<i>Constant frequency 3</i>	Defines constant frequency 3.	15.00 Hz; 18.00 Hz (95.20 b0)
	-500.00...500.00 Hz	Constant frequency 3.	See par. 46.02
28.29	<i>Constant frequency 4</i>	Defines constant frequency 4.	20.00 Hz; 24.00 Hz (95.20 b0)
	-500.00...500.00 Hz	Constant frequency 4.	See par. 46.02
28.30	<i>Constant frequency 5</i>	Defines constant frequency 5.	25.00 Hz; 30.00 Hz (95.20 b0)
	-500.00...500.00 Hz	Constant frequency 5.	See par. 46.02
28.31	<i>Constant frequency 6</i>	Defines constant frequency 6.	40.00 Hz; 48.00 Hz (95.20 b0)
	-500.00...500.00 Hz	Constant frequency 6.	See par. 46.02
28.32	<i>Constant frequency 7</i>	Defines constant frequency 7.	50.00 Hz; 60.00 Hz (95.20 b0)
	-500.00...500.00 Hz	Constant frequency 7.	See par. 46.02

No.	Name/Value	Description	Def/FbEq16											
28.41	<i>Frequency ref safe</i>	Defines a safe frequency reference value that is used with supervision functions such as <ul style="list-style-type: none"> • 12.03 AI supervision function • 49.05 Communication loss action • 50.02 FBA A comm loss func. • 80.17 Maximum flow protection • 80.18 Minimum flow protection. 	0.00 Hz											
	-500.00...500.00 Hz	Safe frequency reference.	See par. 46.02											
28.46	<i>Constant frequency sel5</i>	When bit 0 of parameter 28.21 Constant frequency function is 0 (Separate), selects a source that activates constant frequency 4. For the selections, see parameter 28.22 Constant frequency sel1 .	<i>Always off</i>											
28.47	<i>Constant frequency sel6</i>	When bit 0 of parameter 28.21 Constant frequency function is 0 (Separate), selects a source that activates constant frequency 4. For the selections, see parameter 28.22 Constant frequency sel1 .	<i>Always off</i>											
28.51	<i>Critical frequency function</i>	Enables/disables the critical frequencies function. Also determines whether the specified ranges are effective in both rotating directions or not. See also section Critical speeds/frequencies (page 132).	0000b											
<table border="1"> <thead> <tr> <th>Bit</th> <th>Name</th> <th>Information</th> </tr> </thead> <tbody> <tr> <td rowspan="2">0</td> <td rowspan="2">Crit freq</td> <td>1 = Enable: Critical frequencies enabled.</td> </tr> <tr> <td>0 = Disable: Critical frequencies disabled.</td> </tr> <tr> <td rowspan="2">1</td> <td rowspan="2">Sign mode</td> <td>1 = According to par: The signs of parameters 28.52...28.57 are taken into account.</td> </tr> <tr> <td>0 = Absolute: Parameters 28.52...28.57 are handled as absolute values. Each range is effective in both directions of rotation.</td> </tr> </tbody> </table>				Bit	Name	Information	0	Crit freq	1 = Enable: Critical frequencies enabled.	0 = Disable: Critical frequencies disabled.	1	Sign mode	1 = According to par: The signs of parameters 28.52...28.57 are taken into account.	0 = Absolute: Parameters 28.52...28.57 are handled as absolute values. Each range is effective in both directions of rotation.
Bit	Name	Information												
0	Crit freq	1 = Enable: Critical frequencies enabled.												
		0 = Disable: Critical frequencies disabled.												
1	Sign mode	1 = According to par: The signs of parameters 28.52...28.57 are taken into account.												
		0 = Absolute: Parameters 28.52...28.57 are handled as absolute values. Each range is effective in both directions of rotation.												
	0000h...FFFFh	Critical frequencies configuration word.	1 = 1											
28.52	<i>Critical frequency 1 low</i>	Defines the low limit for critical frequency 1. Note: This value must be less than or equal to the value of 28.53 Critical frequency 1 high .	0.00 Hz											
	-500.00...500.00 Hz	Low limit for critical frequency 1.	See par. 46.02											
28.53	<i>Critical frequency 1 high</i>	Defines the high limit for critical frequency 1. Note: This value must be greater than or equal to the value of 28.52 Critical frequency 1 low .	0.00 Hz											
	-500.00...500.00 Hz	High limit for critical frequency 1.	See par. 46.02											
28.54	<i>Critical frequency 2 low</i>	Defines the low limit for critical frequency 2. Note: This value must be less than or equal to the value of 28.55 Critical frequency 2 high .	0.00 Hz											
	-500.00...500.00 Hz	Low limit for critical frequency 2.	See par. 46.02											

No.	Name/Value	Description	Def/FbEq16
28.55	<i>Critical frequency 2 high</i>	Defines the high limit for critical frequency 2. Note: This value must be greater than or equal to the value of 28.54 Critical frequency 2 low .	0.00 Hz
	-500.00...500.00 Hz	High limit for critical frequency 2.	See par. 46.02
28.56	<i>Critical frequency 3 low</i>	Defines the low limit for critical frequency 3. Note: This value must be less than or equal to the value of 28.57 Critical frequency 3 high .	0.00 Hz
	-500.00...500.00 Hz	Low limit for critical frequency 3.	See par. 46.02
28.57	<i>Critical frequency 3 high</i>	Defines the high limit for critical frequency 3. Note: This value must be greater than or equal to the value of 28.56 Critical frequency 3 low .	0.00 Hz
	-500.00...500.00 Hz	High limit for critical frequency 3.	See par. 46.02
28.72	<i>Freq acceleration time 1</i>	Defines acceleration time 1 as the time required for the frequency to change from zero to the frequency defined by parameter 46.02 Frequency scaling . After this frequency has been reached, the acceleration continues with the same rate to the value defined by parameter 30.14 Maximum frequency . If the reference increases faster than the set acceleration rate, the motor will follow the acceleration rate. If the reference increases slower than the set acceleration rate, the motor frequency will follow the reference. If the acceleration time is set too short, the drive will automatically prolong the acceleration in order not to exceed the drive torque limits.	5.000 s
	0.000...1800.000 s	Acceleration time 1.	10 = 1 s
28.73	<i>Freq deceleration time 1</i>	Defines deceleration time 1 as the time required for the frequency to change from the frequency defined by parameter 46.02 Frequency scaling (not from parameter 30.14 Maximum frequency) to zero. If there is any doubt about the deceleration time being too short, ensure that DC overvoltage control (30.30 Overvoltage control) is on. Note: If a short deceleration time is needed for a high inertia application, the drive should be equipped with braking equipment such as a brake chopper and brake resistor.	5.000 s
	0.000...1800.000 s	Deceleration time 1.	10 = 1 s
28.76	<i>Freq ramp in zero source</i>	Selects a source that forces the frequency reference to zero. 0 = Force frequency reference to zero 1 = Normal operation	<i>Inactive</i>
	Active	0.	0
	Inactive	1.	1
	DI1	Digital input DI1 (10.02 DI delayed status , bit 0).	2
	DI2	Digital input DI2 (10.02 DI delayed status , bit 1).	3
	DI3	Digital input DI3 (10.02 DI delayed status , bit 2).	4
	DI4	Digital input DI4 (10.02 DI delayed status , bit 3).	5
	DI5	Digital input DI5 (10.02 DI delayed status , bit 4).	6
	DI6	Digital input DI6 (10.02 DI delayed status , bit 5).	7
	<i>Other [bit]</i>	Source selection (see Terms and abbreviations on page 285).	-

No.	Name/Value	Description	Def/FbEq16
28.82	<i>Shape time 1</i>	Defines the shape of acceleration ramp at the beginning of acceleration.	0.000 s
	0.000...1800.000 s	Shape time 1.	10 = 1 s
28.92	<i>Frequency ref act 3</i>	Displays the frequency reference after selection (<i>19.11 Ext1/Ext2 selection</i>). See control chain diagram <i>Frequency reference selection</i> on page 268. This parameter is read-only.	-
	-500.00...500.00 Hz	Frequency reference after selection.	See par. <i>46.02</i>
28.96	<i>Frequency ref act 7</i>	Displays the frequency reference after application of constant frequencies, control panel reference, etc. See control chain diagram <i>Frequency reference selection</i> on page 268. This parameter is read-only.	-
	-500.00...500.00 Hz	Frequency reference 7.	See par. <i>46.02</i>
28.97	<i>Frequency ref unlimited</i>	Displays the frequency reference after application of critical frequencies, but before ramping and limiting. See control chain diagram <i>Frequency reference modification</i> on page 269. This parameter is read-only.	-
	-500.00...500.00 Hz	Frequency reference before ramping and limiting.	See par. <i>46.02</i>

30 Limits

Drive operation limits.

30.01 Limit word 1Displays limit word 1.
This parameter is read-only.

Bit	Name	Description
0	Torq lim	1 = Drive torque is being limited by the motor control (undervoltage control, current control, load angle control or pull-out control), or by the torque limits defined by parameters.
1...4	Reserved	
5	Tlim max speed	1 = Torque reference is being limited by the rush control because of maximum speed limit (<i>30.12 Maximum speed</i>)
6	Tlim min speed	1 = Torque reference is being limited by the rush control because of minimum speed limit (<i>30.11 Minimum speed</i>)
7	Max speed ref lim	1 = Speed reference is being limited by <i>30.12 Maximum speed</i>
8	Min speed ref lim	1 = Speed reference is being limited by <i>30.11 Minimum speed</i>
9	Max freq ref lim	1 = Frequency reference is being limited by <i>30.14 Maximum frequency</i>
10	Min freq ref lim	1 = Frequency reference is being limited by <i>30.13 Minimum frequency</i>
11...15	Reserved	



0000h...FFFFh

Limit word 1.

1 = 1

No.	Name/Value	Description	Def/FbEq16																																																			
30.02	<i>Torque limit status</i>	Displays the torque controller limitation status word. This parameter is read-only.	-																																																			
<table border="1"> <thead> <tr> <th>Bit</th> <th>Name</th> <th>Description</th> </tr> </thead> <tbody> <tr> <td>0</td> <td>Undervoltage</td> <td>*1 = Intermediate DC circuit undervoltage</td> </tr> <tr> <td>1</td> <td>Overvoltage</td> <td>*1 = Intermediate DC circuit overvoltage</td> </tr> <tr> <td>2</td> <td>Minimum torque</td> <td>*1 = Torque is being limited by 30.19 Minimum torque 1, 30.26 Power motoring limit or 30.27 Power generating limit</td> </tr> <tr> <td>3</td> <td>Maximum torque</td> <td>*1 = Torque is being limited by 30.20 Maximum torque 1, 30.26 Power motoring limit or 30.27 Power generating limit</td> </tr> <tr> <td>4</td> <td>Internal current</td> <td>1 = An inverter current limit (identified by bits 8...11) is active</td> </tr> <tr> <td>5</td> <td>Load angle</td> <td>(With permanent magnet motors and reluctance motors only) 1 = Load angle limit is active, ie, the motor cannot produce any more torque</td> </tr> <tr> <td>6</td> <td>Motor pullout</td> <td>(With asynchronous motors only) Motor pull-out limit is active, ie, the motor cannot produce any more torque</td> </tr> <tr> <td>7</td> <td colspan="2">Reserved</td> </tr> <tr> <td>8</td> <td>Thermal</td> <td>1 = Input current is being limited by the main circuit thermal limit</td> </tr> <tr> <td>9</td> <td>Max current</td> <td>*1 = Maximum output current (I_{MAX}) is being limited</td> </tr> <tr> <td>10</td> <td>User current</td> <td>*1 = Output current is being limited by 30.17 Maximum current</td> </tr> <tr> <td>11</td> <td>Thermal IGBT</td> <td>*1 = Output current is being limited by a calculated thermal current value</td> </tr> <tr> <td>12</td> <td>IGBT overtemperature</td> <td>*1 = Output current is being limited because of estimated IGBT temperature</td> </tr> <tr> <td>13</td> <td>IGBT overload</td> <td>*1 = Output current is being limited because of IGBT junction to case temperature</td> </tr> <tr> <td>14...15</td> <td colspan="2">Reserved</td> </tr> <tr> <td colspan="3">*Only one out of bits 0...3, and one out of bits 9...11 can be on simultaneously. The bit typically indicates the limit that is exceeded first.</td> </tr> </tbody> </table>				Bit	Name	Description	0	Undervoltage	*1 = Intermediate DC circuit undervoltage	1	Overvoltage	*1 = Intermediate DC circuit overvoltage	2	Minimum torque	*1 = Torque is being limited by 30.19 Minimum torque 1 , 30.26 Power motoring limit or 30.27 Power generating limit	3	Maximum torque	*1 = Torque is being limited by 30.20 Maximum torque 1 , 30.26 Power motoring limit or 30.27 Power generating limit	4	Internal current	1 = An inverter current limit (identified by bits 8...11) is active	5	Load angle	(With permanent magnet motors and reluctance motors only) 1 = Load angle limit is active, ie, the motor cannot produce any more torque	6	Motor pullout	(With asynchronous motors only) Motor pull-out limit is active, ie, the motor cannot produce any more torque	7	Reserved		8	Thermal	1 = Input current is being limited by the main circuit thermal limit	9	Max current	*1 = Maximum output current (I_{MAX}) is being limited	10	User current	*1 = Output current is being limited by 30.17 Maximum current	11	Thermal IGBT	*1 = Output current is being limited by a calculated thermal current value	12	IGBT overtemperature	*1 = Output current is being limited because of estimated IGBT temperature	13	IGBT overload	*1 = Output current is being limited because of IGBT junction to case temperature	14...15	Reserved		*Only one out of bits 0...3, and one out of bits 9...11 can be on simultaneously. The bit typically indicates the limit that is exceeded first.		
Bit	Name	Description																																																				
0	Undervoltage	*1 = Intermediate DC circuit undervoltage																																																				
1	Overvoltage	*1 = Intermediate DC circuit overvoltage																																																				
2	Minimum torque	*1 = Torque is being limited by 30.19 Minimum torque 1 , 30.26 Power motoring limit or 30.27 Power generating limit																																																				
3	Maximum torque	*1 = Torque is being limited by 30.20 Maximum torque 1 , 30.26 Power motoring limit or 30.27 Power generating limit																																																				
4	Internal current	1 = An inverter current limit (identified by bits 8...11) is active																																																				
5	Load angle	(With permanent magnet motors and reluctance motors only) 1 = Load angle limit is active, ie, the motor cannot produce any more torque																																																				
6	Motor pullout	(With asynchronous motors only) Motor pull-out limit is active, ie, the motor cannot produce any more torque																																																				
7	Reserved																																																					
8	Thermal	1 = Input current is being limited by the main circuit thermal limit																																																				
9	Max current	*1 = Maximum output current (I_{MAX}) is being limited																																																				
10	User current	*1 = Output current is being limited by 30.17 Maximum current																																																				
11	Thermal IGBT	*1 = Output current is being limited by a calculated thermal current value																																																				
12	IGBT overtemperature	*1 = Output current is being limited because of estimated IGBT temperature																																																				
13	IGBT overload	*1 = Output current is being limited because of IGBT junction to case temperature																																																				
14...15	Reserved																																																					
*Only one out of bits 0...3, and one out of bits 9...11 can be on simultaneously. The bit typically indicates the limit that is exceeded first.																																																						
0000h...FFFFh	Torque limitation status word.		1 = 1																																																			

No.	Name/Value	Description	Def/FbEq16
30.11	<i>Minimum speed</i>	<p>Defines together with 30.12 Maximum speed the allowed speed range. See the figure below.</p> <p>A positive or zero minimum speed value defines two ranges, one positive and one negative.</p> <p>A negative minimum speed value defines one range.</p> <p>WARNING! The absolute value of 30.11 Minimum speed must not be higher than the absolute value of 30.12 Maximum speed.</p> <p>WARNING! In speed control mode only. In frequency control mode, use frequency limits (30.13 and 30.14).</p>	0.00 rpm
<div style="display: flex; justify-content: space-around;"> <div data-bbox="157 421 508 628"> </div> <div data-bbox="564 421 945 628"> </div> <div data-bbox="564 644 945 836"> </div> </div>			
	-30000.00... 30000.00 rpm	Minimum allowed speed.	See par. 46.01
30.12	<i>Maximum speed</i>	<p>Defines together with 30.11 Minimum speed the allowed speed range. See parameter 30.11 Minimum speed.</p> <p>Note: This parameter does not affect the speed acceleration and deceleration ramp times. See parameter 46.01 Speed scaling.</p>	1500.00 rpm; 1800.00 rpm (95.20 b0)
	-30000.00... 30000.00 rpm	Maximum speed.	See par. 46.01

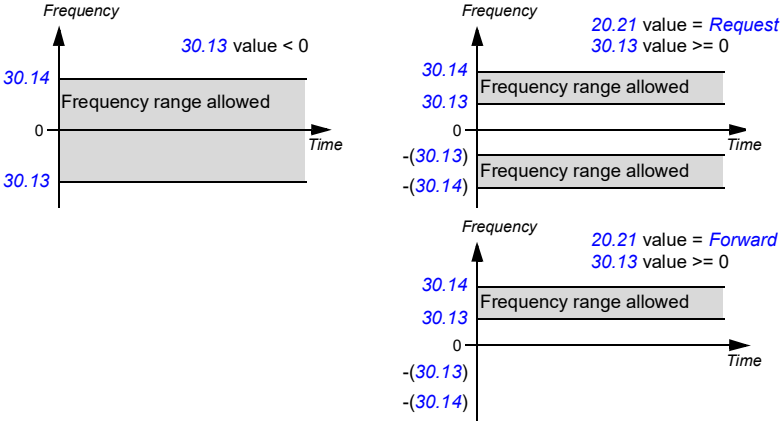
No.	Name/Value	Description	Def/FbEq16
30.13	<i>Minimum frequency</i>	<p>Defines together with 30.14 Maximum frequency the allowed frequency range. See the figure.</p> <p>A positive or zero minimum frequency value defines two ranges, one positive and one negative.</p> <p> WARNING! The absolute value of 30.13 Minimum frequency must not be higher than the absolute value of 30.14 Maximum frequency.</p> <p> WARNING! in frequency control mode only.</p> 	0.00 Hz
	-500.00...500.00 Hz	Minimum frequency.	See par. 46.02
30.14	<i>Maximum frequency</i>	<p>Defines together with 30.13 Minimum frequency the allowed frequency range. See parameter 30.13 Minimum frequency.</p> <p>Note: This parameter does not affect the frequency acceleration and deceleration ramp times. See parameter 46.02 Frequency scaling.</p>	50.00 Hz; 60.00 Hz (95.20 b0)
	-500.00...500.00 Hz	Maximum frequency.	See par. 46.02
30.17	<i>Maximum current</i>	<p>Defines the maximum allowed motor current. This depends on the drive type; it is automatically determined on the basis of the rating.</p> <p>The system sets the default value to 90% of the rated current so you can increase the parameter value by 10% if needed (not valid for ACQ580-01-12A7-4 drive type).</p>	0.00 A
	0.00...30000.00 A	Maximum motor current.	1 = 1 A
30.19	<i>Minimum torque 1</i>	<p>Defines a minimum torque limit for the drive (in percent of nominal motor torque). Note: If your application, like a pump or a fan, requires that the motor must rotate in one direction only, use speed/ frequency limit (30.11 Minimum speed/30.13 Minimum frequency) to achieve this. Do not set parameter 30.19 Minimum torque 1 or 30.27 Power generating limit to 0%, as the drive is then not able to stop correctly.</p>	-300.0%
	-1600.0...0.0%	Minimum torque limit 1.	See par. 46.03

No.	Name/Value	Description	Def/FbEq16
30.20	<i>Maximum torque 1</i>	<ul style="list-style-type: none"> Defines a maximum torque limit for the drive (in percent of nominal motor torque). 	300.0%
	0.0...1600.0%	Maximum torque 1.	See par. 46.03
30.26	<i>Power motoring limit</i>	Defines the maximum allowed power fed by the inverter to the motor in percent of nominal motor power.	300.00%
	0.00...600.00%	Maximum motoring power.	1 = 1%
30.27	<i>Power generating limit</i>	<p>Defines the maximum allowed power fed by the motor to the inverter in percent of nominal motor power.</p> <p>Note: If your application, like a pump or a fan, requires that the motor must rotate in one direction only, use speed/frequency limit (30.11 Minimum speed/30.13 Minimum frequency), or direction limit (20.21 Direction) to achieve this. Do not set parameter 30.19 Minimum torque 1 or 30.27 Power generating limit to 0%, as the drive is then not able to stop correctly.</p>	-300.00%
	-600.00...0.00%	Maximum generating power.	1 = 1%
30.30	<i>Overvoltage control</i>	<p>Enables the overvoltage control of the intermediate DC link. Fast braking of a high inertia load causes the voltage to rise to the overvoltage control limit. To prevent the DC voltage from exceeding the limit, the overvoltage controller automatically decreases the braking torque.</p> <p>Note: If the drive is equipped with a brake chopper and resistor, or a regenerative supply unit, the controller must be disabled.</p>	<i>Enable</i>
	Disable	Overvoltage control disabled.	0
	Enable	Overvoltage control enabled.	1
30.31	<i>Undervoltage control</i>	<p>Enables the undervoltage control of the intermediate DC link. If the DC voltage drops due to input power cut off, the undervoltage controller will automatically decrease the motor torque in order to keep the voltage above the lower limit. By decreasing the motor torque, the inertia of the load will cause regeneration back to the drive, keeping the DC link charged and preventing an undervoltage trip until the motor coasts to a stop. This will act as a power-loss ride-through functionality in systems with high inertia, such as a centrifuge or a fan.</p>	<i>Enable</i>
	Disable	Undervoltage control disabled.	0
	Enable	Undervoltage control enabled.	1
30.35	<i>Thermal current limitation</i>	Enables/disables temperature-based output current limitation. The limitation should only be disabled if required by the application.	<i>Enable</i>
	Disable	Thermal current limitation disabled.	0
	Enable	Thermal current limitation enabled.	1

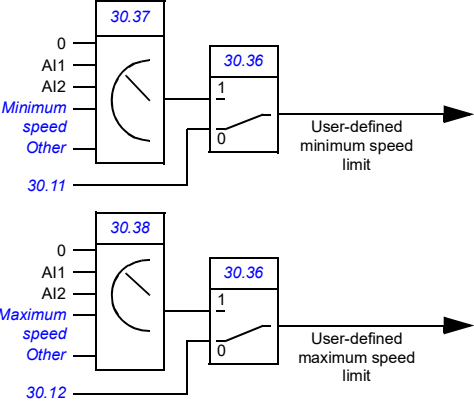
No.	Name/Value	Description	Def/FbEq16
30.36	<i>Speed limit selection</i>	<p>Selects a source that switches between two different predefined adjustable speed limit sets.</p> <p>0 = minimum speed limit defined by 30.11 and maximum speed limit defined by 30.12 are active</p> <p>1 = minimum speed limit selected by 30.37 and maximum speed limit defined by 30.38 are active.</p> <p>The user can define two sets of speed limits, and switch between the sets using a binary source such as a digital input.</p> <p>The first set of limits is defined by parameters 30.11 <i>Minimum speed</i> and 30.12 <i>Maximum speed</i>. The second set has selector parameters for both the minimum (30.37) and maximum (30.38) limits that allows the use of a selectable analog source (such as an analog input).</p> 	<i>Not selected</i>
	Not selected	Adjustable speed limits are disabled. (Minimum speed limit defined by 30.11 <i>Minimum speed</i> and maximum speed limit defined by 30.12 <i>Maximum speed</i> are active).	0
	Selected	Adjustable speed limits are enabled. (Minimum speed limit defined by 30.37 <i>Minimum speed source</i> and maximum speed limit defined by 30.38 <i>Maximum speed source</i> are active).	1
	Ext1 active	Adjustable speed limits are enabled if EXT1 is active.	2
	Ext2 active	Adjustable speed limits are enabled if EXT2 is active.	3
	Reserved		4
	DI1	Digital input DI1 (10.02 <i>DI delayed status</i> , bit 0).	5
	DI2	Digital input DI2 (10.02 <i>DI delayed status</i> , bit 1).	6
	DI3	Digital input DI3 (10.02 <i>DI delayed status</i> , bit 2).	7
	DI4	Digital input DI4 (10.02 <i>DI delayed status</i> , bit 3).	8
	DI5	Digital input DI5 (10.02 <i>DI delayed status</i> , bit 4).	9
	DI6	Digital input DI6 (10.02 <i>DI delayed status</i> , bit 5).	10
	Reserved		11
	<i>Other [bit]</i>	Source selection (see <i>Terms and abbreviations</i> on page 285).	-

No.	Name/Value	Description	Def/FbEq16
30.37	<i>Minimum speed source</i>	Defines the source of a minimum speed limit for the drive when the source is selected by 30.36 Speed limit selection . Note: In vector motor control mode only. In scalar motor control mode, use frequency limits 30.13 and 30.14 .	<i>Minimum speed</i>
	Zero	None.	0
	AI1 scaled	12.12 AI1 scaled value (see page 321).	1
	AI2 scaled	12.22 AI2 scaled value (see page 323).	2
	Reserved		3...10
	Minimum speed	30.11 Minimum speed .	11
	<i>Other</i>	Source selection (see Terms and abbreviations on page 285).	-
30.38	<i>Maximum speed source</i>	Defines the source of a maximum speed limit for the drive when the source is selected by 30.36 Speed limit selection . Note: In vector motor control mode only. In scalar motor control mode, use frequency limits 30.13 and 30.14 .	<i>Maximum speed</i>
	Zero	None.	0
	AI1 scaled	12.12 AI1 scaled value (see page 321).	1
	AI2 scaled	12.22 AI2 scaled value (see page 323).	2
	Reserved		3...11
	Maximum speed	30.12 Maximum speed .	12
	<i>Other</i>	Source selection (see Terms and abbreviations on page 285).	-
30.101	<i>LSU limit word 1</i>	(<i>Only visible for ACQ580-31 and ACQ580-34</i>). Displays limit word 1 of the supply unit. This parameter is read-only.	-

Bit	Name	Description
0	P user ref max	1 = Power reference is being limited by supply control program parameters
1	P user ref min	
2	P user max	1 = Power is being limited by parameter 30.149
3	Reserved	
4	P cooling overtemp	1 = Power reference is being limited because of coolant overtemperature
5	P power unit overtemp	1 = Power reference is being limited because of supply unit overtemperature
6...15	Reserved	

0000h...FFFFh	Supply unit limit word 1.	1 = 1
---------------	---------------------------	-------

No.	Name/Value	Description	Def/FbEq16																																																
30.102	LSU limit word 2	(Only visible for ACQ580-31 and ACQ580-34). Displays limit word 2 of the supply unit. This parameter is read-only.	-																																																
<table border="1"> <thead> <tr> <th>Bit</th> <th>Name</th> <th>Description</th> </tr> </thead> <tbody> <tr> <td>0</td> <td>Q user ref max</td> <td>1 = Reactive power reference is being limited</td> </tr> <tr> <td>1</td> <td>Q user ref min</td> <td></td> </tr> <tr> <td>2</td> <td>Q cooling overtemp</td> <td>1 = Reactive power reference is being limited because of coolant overtemperature</td> </tr> <tr> <td>3</td> <td>Reserved</td> <td></td> </tr> <tr> <td>4</td> <td>AC overvoltage</td> <td>1 = AC overvoltage protection</td> </tr> <tr> <td>5...6</td> <td>Reserved</td> <td></td> </tr> <tr> <td>7</td> <td>AC diff max</td> <td>1 = (When AC voltage-type reactive power reference is being used)</td> </tr> <tr> <td>8</td> <td>AC diff min</td> <td>Input of AC control is being limited</td> </tr> <tr> <td>9...15</td> <td>Reserved</td> <td></td> </tr> </tbody> </table>				Bit	Name	Description	0	Q user ref max	1 = Reactive power reference is being limited	1	Q user ref min		2	Q cooling overtemp	1 = Reactive power reference is being limited because of coolant overtemperature	3	Reserved		4	AC overvoltage	1 = AC overvoltage protection	5...6	Reserved		7	AC diff max	1 = (When AC voltage-type reactive power reference is being used)	8	AC diff min	Input of AC control is being limited	9...15	Reserved																			
Bit	Name	Description																																																	
0	Q user ref max	1 = Reactive power reference is being limited																																																	
1	Q user ref min																																																		
2	Q cooling overtemp	1 = Reactive power reference is being limited because of coolant overtemperature																																																	
3	Reserved																																																		
4	AC overvoltage	1 = AC overvoltage protection																																																	
5...6	Reserved																																																		
7	AC diff max	1 = (When AC voltage-type reactive power reference is being used)																																																	
8	AC diff min	Input of AC control is being limited																																																	
9...15	Reserved																																																		
	0000h...FFFFh	Supply unit limit word 2.	1 = 1																																																
30.103	LSU limit word 3	(Only visible for ACQ580-31 and ACQ580-34). Displays limit word 3 of the supply unit. This parameter is read-only.	-																																																
<table border="1"> <thead> <tr> <th>Bit</th> <th>Name</th> <th>Description</th> </tr> </thead> <tbody> <tr> <td>0</td> <td>Undervoltage limit</td> <td>1 = Power is being limited by the undervoltage controller</td> </tr> <tr> <td>1</td> <td>Overvoltage limit</td> <td>1 = Power is being limited by the overvoltage controller</td> </tr> <tr> <td>2</td> <td>Motoring power</td> <td>1 = Power is being limited by temperature or user power limits (see parameter 30.149)</td> </tr> <tr> <td>3</td> <td>Reserved</td> <td></td> </tr> <tr> <td>4</td> <td>Active current limit</td> <td>1 = Active current is being limited. For details, see bits 6...9 and 14...15.</td> </tr> <tr> <td>5</td> <td>Reactive current limit</td> <td>1 = Reactive current is being limited. For details, see bits 12...13.</td> </tr> <tr> <td>6</td> <td>Thermal limit</td> <td>1 = Active current is being limited by internal main circuit thermal limit</td> </tr> <tr> <td>7</td> <td>SOA limit</td> <td>1 = Active current is being limited by internal safe operation area limit</td> </tr> <tr> <td>8</td> <td>User current limit</td> <td>1 = Active current is being limited by current limit set by supply control program parameters</td> </tr> <tr> <td>9</td> <td>Thermal IGBT</td> <td>1 = Active current is being limited based on internal maximum thermal IGBT stress limit</td> </tr> <tr> <td>10...11</td> <td>Reserved</td> <td></td> </tr> <tr> <td>12</td> <td>Q act neg</td> <td>1 = Negative reactive current is being limited by maximum total current</td> </tr> <tr> <td>13</td> <td>Q act pos</td> <td>1 = Positive reactive current is being limited by maximum total current</td> </tr> <tr> <td>14</td> <td>P act neg</td> <td>1 = Negative active current is being limited by maximum total current</td> </tr> <tr> <td>15</td> <td>P act pos</td> <td>1 = Positive reactive current is being limited by maximum total current</td> </tr> </tbody> </table>				Bit	Name	Description	0	Undervoltage limit	1 = Power is being limited by the undervoltage controller	1	Overvoltage limit	1 = Power is being limited by the overvoltage controller	2	Motoring power	1 = Power is being limited by temperature or user power limits (see parameter 30.149)	3	Reserved		4	Active current limit	1 = Active current is being limited. For details, see bits 6...9 and 14...15.	5	Reactive current limit	1 = Reactive current is being limited. For details, see bits 12...13.	6	Thermal limit	1 = Active current is being limited by internal main circuit thermal limit	7	SOA limit	1 = Active current is being limited by internal safe operation area limit	8	User current limit	1 = Active current is being limited by current limit set by supply control program parameters	9	Thermal IGBT	1 = Active current is being limited based on internal maximum thermal IGBT stress limit	10...11	Reserved		12	Q act neg	1 = Negative reactive current is being limited by maximum total current	13	Q act pos	1 = Positive reactive current is being limited by maximum total current	14	P act neg	1 = Negative active current is being limited by maximum total current	15	P act pos	1 = Positive reactive current is being limited by maximum total current
Bit	Name	Description																																																	
0	Undervoltage limit	1 = Power is being limited by the undervoltage controller																																																	
1	Overvoltage limit	1 = Power is being limited by the overvoltage controller																																																	
2	Motoring power	1 = Power is being limited by temperature or user power limits (see parameter 30.149)																																																	
3	Reserved																																																		
4	Active current limit	1 = Active current is being limited. For details, see bits 6...9 and 14...15.																																																	
5	Reactive current limit	1 = Reactive current is being limited. For details, see bits 12...13.																																																	
6	Thermal limit	1 = Active current is being limited by internal main circuit thermal limit																																																	
7	SOA limit	1 = Active current is being limited by internal safe operation area limit																																																	
8	User current limit	1 = Active current is being limited by current limit set by supply control program parameters																																																	
9	Thermal IGBT	1 = Active current is being limited based on internal maximum thermal IGBT stress limit																																																	
10...11	Reserved																																																		
12	Q act neg	1 = Negative reactive current is being limited by maximum total current																																																	
13	Q act pos	1 = Positive reactive current is being limited by maximum total current																																																	
14	P act neg	1 = Negative active current is being limited by maximum total current																																																	
15	P act pos	1 = Positive reactive current is being limited by maximum total current																																																	
	0000h...FFFFh	Supply unit limit word 3.	1 = 1																																																

No.	Name/Value	Description	Def/FbEq16																		
30.104	<i>LSU limit word 4</i>	(Only visible for ACQ580-31 and ACQ580-34). Displays limit word 4 of the supply unit. This parameter is read-only.	-																		
<table border="1"> <thead> <tr> <th>Bit</th> <th>Name</th> <th>Description</th> </tr> </thead> <tbody> <tr> <td>0</td> <td>Udc ref max</td> <td>1 = DC reference is being limited by supply control program parameters</td> </tr> <tr> <td>1</td> <td>Udc ref min</td> <td></td> </tr> <tr> <td>2</td> <td>User I max</td> <td>1 = Current is being limited by supply control program parameters</td> </tr> <tr> <td>3</td> <td>Temp I max</td> <td>1 = Current is being limited based on temperature</td> </tr> <tr> <td>4...15</td> <td>Reserved</td> <td></td> </tr> </tbody> </table>				Bit	Name	Description	0	Udc ref max	1 = DC reference is being limited by supply control program parameters	1	Udc ref min		2	User I max	1 = Current is being limited by supply control program parameters	3	Temp I max	1 = Current is being limited based on temperature	4...15	Reserved	
Bit	Name	Description																			
0	Udc ref max	1 = DC reference is being limited by supply control program parameters																			
1	Udc ref min																				
2	User I max	1 = Current is being limited by supply control program parameters																			
3	Temp I max	1 = Current is being limited based on temperature																			
4...15	Reserved																				
	0000h...FFFFh	Supply unit limit word 4.	1 = 1																		
30.149	<i>LSU maximum power limit</i>	(Only visible for ACQ580-31 and ACQ580-34). Defines a maximum power limit for the supply unit.	130.0%																		
	0.0 ... 200.0%	Maximum power limit for supply unit.	1 = 1%																		

31 Fault functions		Configuration of external events; selection of behavior of the drive upon fault situations.	
31.01	<i>External event 1 source</i>	Defines the source of external event 1. See also parameter <i>31.02 External event 1 type</i> . 0 = Trigger event 1 = Normal operation	<i>Inactive (true)</i>
	Active (false)	0.	0
	Inactive (true)	1.	1
	Reserved		2
	DI1	Digital input DI1 (<i>10.02 DI delayed status</i> , bit 0).	3
	DI2	Digital input DI2 (<i>10.02 DI delayed status</i> , bit 1).	4
	DI3	Digital input DI3 (<i>10.02 DI delayed status</i> , bit 2).	5
	DI4	Digital input DI4 (<i>10.02 DI delayed status</i> , bit 3).	6
	DI5	Digital input DI5 (<i>10.02 DI delayed status</i> , bit 4).	7
	DI6	Digital input DI6 (<i>10.02 DI delayed status</i> , bit 5).	8
	<i>Other [bit]</i>	Source selection (see <i>Terms and abbreviations</i> on page 285).	-
31.02	<i>External event 1 type</i>	Selects the type of external event 1.	<i>Fault</i>
	Fault	The external event generates a fault.	0
	Warning	The external event generates a warning.	1
31.03	<i>External event 2 source</i>	Defines the source of external event 2. See also parameter <i>31.04 External event 2 type</i> . For the selections, see parameter <i>31.01 External event 1 source</i> .	<i>Inactive (true)</i>
31.04	<i>External event 2 type</i>	Selects the type of external event 2.	<i>Fault</i>
	Fault	The external event generates a fault.	0
	Warning	The external event generates a warning.	1

No.	Name/Value	Description	Def/FbEq16
31.05	External event 3 source	Defines the source of external event 3. See also parameter 31.06 External event 3 type . For the selections, see parameter 31.01 External event 1 source .	<i>Inactive (true)</i>
31.06	External event 3 type	Selects the type of external event 3.	<i>Fault</i>
	Fault	The external event generates a fault.	0
	Warning	The external event generates a warning.	1
31.07	External event 4 source	Defines the source of external event 4. See also parameter 31.08 External event 4 type . For the selections, see parameter 31.01 External event 1 source .	<i>Inactive (true)</i>
31.08	External event 4 type	Selects the type of external event 4.	<i>Fault</i>
	Fault	The external event generates a fault.	0
	Warning	The external event generates a warning.	1
31.09	External event 5 source	Defines the source of external event 5. See also parameter 31.10 External event 5 type . For the selections, see parameter 31.01 External event 1 source .	<i>Inactive (true)</i>
31.10	External event 5 type	Selects the type of external event 5.	<i>Fault</i>
	Fault	The external event generates a fault.	0
	Warning	The external event generates a warning.	1
31.11	Fault reset selection	Selects the source of an external fault reset signal. The signal resets the drive after a fault trip if the cause of the fault no longer exists. 0 -> 1 = Reset Notes: <ul style="list-style-type: none"> When the start and stop command is through digital inputs (parameter 20.01 Ext1 commands or 20.06 Ext2 commands) or from local control, and you want to use fault reset from the fieldbus, selection FBA A MCW bit 7 or EFB MCW bit 7 can be used. Whenever the drive is in external control through fieldbus (start and stop command and reference are received through fieldbus), the fault can be reset from the fieldbus regardless of the selection of this parameter. 	<i>Not used</i>
	Not used	0.	0
	Not used	1.	1
	DI1	Digital input DI1 (10.02 DI delayed status , bit 0).	2
	DI2	Digital input DI2 (10.02 DI delayed status , bit 1).	3
	DI3	Digital input DI3 (10.02 DI delayed status , bit 2).	4
	DI4	Digital input DI4 (10.02 DI delayed status , bit 3).	5
	DI5	Digital input DI5 (10.02 DI delayed status , bit 4).	6
	DI6	Digital input DI6 (10.02 DI delayed status , bit 5).	7
	Reserved		8...17
	Timed function 1	Bit 0 of 34.01 Timed functions status (see page 410).	18
	Timed function 2	Bit 1 of 34.01 Timed functions status (see page 410).	19

No.	Name/Value	Description	Def/FbEq16																								
	Timed function 3	Bit 2 of 34.01 Timed functions status (see page 410).	20																								
	Reserved		21...23																								
	Supervision 1	Bit 0 of 32.01 Supervision status (see page 403).	24																								
	Supervision 2	Bit 1 of 32.01 Supervision status (see page 403).	25																								
	Supervision 3	Bit 2 of 32.01 Supervision status (see page 403).	26																								
	Reserved		27...29																								
	FBA MCW bit 7	Control word bit 7 received through fieldbus interface A.	30																								
	Reserved		31																								
	EFB MCW bit 7	Control word bit 7 received through the embedded fieldbus interface.	32																								
	<i>Other [bit]</i>	Source selection (see Terms and abbreviations on page 285).	-																								
31.12	<i>Autoreset selection</i>	<p>Selects faults that are automatically reset. The parameter is a 16-bit word with each bit corresponding to a fault type. Whenever a bit is set to 1, the corresponding fault is automatically reset.</p> <p> WARNING! Before you activate the function, make sure that no dangerous situations can occur. The function restarts the drive automatically and continues operation after a fault.</p> <p>The bits of this binary number correspond to the following faults:</p>	0000h																								
		<table border="1"> <thead> <tr> <th>Bit</th> <th>Fault</th> </tr> </thead> <tbody> <tr> <td>0</td> <td>Overcurrent</td> </tr> <tr> <td>1</td> <td>Overvoltage</td> </tr> <tr> <td>2</td> <td>Undervoltage</td> </tr> <tr> <td>3</td> <td>AI supervision fault</td> </tr> <tr> <td>4...9</td> <td>Reserved</td> </tr> <tr> <td>10</td> <td>Selectable fault (see parameter 31.13 Selectable fault)</td> </tr> <tr> <td>11</td> <td>External fault 1 (from source selected by parameter 31.01 External event 1 source)</td> </tr> <tr> <td>12</td> <td>External fault 2 (from source selected by parameter 31.03 External event 2 source)</td> </tr> <tr> <td>13</td> <td>External fault 3 (from source selected by parameter 31.05 External event 3 source)</td> </tr> <tr> <td>14</td> <td>External fault 4 (from source selected by parameter 31.07 External event 4 source)</td> </tr> <tr> <td>15</td> <td>External fault 5 (from source selected by parameter 31.09 External event 5 source)</td> </tr> </tbody> </table>	Bit	Fault	0	Overcurrent	1	Overvoltage	2	Undervoltage	3	AI supervision fault	4...9	Reserved	10	Selectable fault (see parameter 31.13 Selectable fault)	11	External fault 1 (from source selected by parameter 31.01 External event 1 source)	12	External fault 2 (from source selected by parameter 31.03 External event 2 source)	13	External fault 3 (from source selected by parameter 31.05 External event 3 source)	14	External fault 4 (from source selected by parameter 31.07 External event 4 source)	15	External fault 5 (from source selected by parameter 31.09 External event 5 source)	
Bit	Fault																										
0	Overcurrent																										
1	Overvoltage																										
2	Undervoltage																										
3	AI supervision fault																										
4...9	Reserved																										
10	Selectable fault (see parameter 31.13 Selectable fault)																										
11	External fault 1 (from source selected by parameter 31.01 External event 1 source)																										
12	External fault 2 (from source selected by parameter 31.03 External event 2 source)																										
13	External fault 3 (from source selected by parameter 31.05 External event 3 source)																										
14	External fault 4 (from source selected by parameter 31.07 External event 4 source)																										
15	External fault 5 (from source selected by parameter 31.09 External event 5 source)																										
	0000h...FFFFh	Automatic reset configuration word.	1 = 1																								
31.13	<i>Selectable fault</i>	Defines the fault that can be automatically reset using parameter 31.12 Autoreset selection , bit 10. Faults are listed in chapter Fault tracing (page 190).	0000h																								
	0000h...FFFFh	Fault code.	1 = 1																								
31.14	<i>Number of trials</i>	Defines the maximum number of automatic resets that the drive is allowed to attempt within the time specified by 31.15 Total trials time . If the fault persists, subsequent reset attempts will be made at intervals defined by 31.16 Delay time . The faults to be automatically reset are defined by 31.12 Autoreset selection .	0																								
	0...5	Number of automatic resets.	1 = 1																								

No.	Name/Value	Description	Def/FbEq16
31.15	Total trials time	Defines a time window for automatic fault resets. The maximum number of attempts made during any period of this length is defined by 31.14 Number of trials . Note: If the fault condition remains and cannot be reset, each reset attempt will generate an event and start a new time window. In practice, if the specified number of resets (31.14) at specified intervals (31.16) take longer than the value of 31.15 , the drive will continue to attempt resetting the fault until the cause is eventually removed.	30.0 s
	1.0...600.0 s	Time for automatic resets.	10 = 1 s
31.16	Delay time	Defines the time that the drive will wait after a fault before attempting an automatic reset. See parameter 31.12 Autoreset selection .	0.0 s
	0.0...120.0 s	Autoreset delay.	10 = 1 s
31.19	Motor phase loss	Selects how the drive reacts when a motor phase loss is detected. In scalar motor control mode: <ul style="list-style-type: none"> The supervision activates above 10% of the motor nominal frequency. If any of the phase currents stays very small for a certain time limit, the output phase loss fault is given. If the motor nominal current is below 1/6 of the drive nominal current or there is no motor connected, ABB recommends to disable the motor output phase loss function. 	<i>Fault</i>
	No action	No action taken.	0
	Fault	Drive trips on fault 3381 Output phase loss .	1
31.21	Supply phase loss	Selects how the drive reacts when a supply phase loss is detected.	<i>Fault</i>
	No action	No action taken.	0
	Fault	Drive trips on fault 3130 Input phase loss .	1

No.	Name/Value	Description	Def/FbEq16																								
31.22	<i>STO indication run/stop</i>	<p>Selects which indications are given when one or both Safe torque off (STO) signals are switched off or lost. The indications also depend on whether the drive is running or stopped when this occurs.</p> <p>The tables at each selection below show the indications generated with that particular setting.</p> <p>Notes:</p> <ul style="list-style-type: none"> This parameter does not affect the operation of the STO function itself. The STO function will operate regardless of the setting of this parameter: a running drive will stop upon removal of one or both STO signals, and will not start until both STO signals are restored and all faults reset. The loss of only one STO signal always generates a fault as it is interpreted as a malfunction. With the CPTC-02 ATEX-certified thermistor protection module, follow the instructions given in the <i>CPTC-02 ATEX-certified thermistor protection module, Ex II (2) GD (+L537+Q971) user's manual (3AXD5000030058 [English])</i>. <p>For more information on the STO, see chapter <i>The Safe torque off function</i> in the <i>Hardware manual</i> of the drive.</p>	<i>Fault/Fault</i>																								
	Fault/Fault	<table border="1" data-bbox="339 675 850 922"> <thead> <tr> <th colspan="2">Inputs</th> <th rowspan="2">Indication (running or stopped)</th> </tr> <tr> <th>IN1</th> <th>IN2</th> </tr> </thead> <tbody> <tr> <td>0</td> <td>0</td> <td>Fault <i>5091 Safe torque off</i></td> </tr> <tr> <td>0</td> <td>1</td> <td>Faults <i>5091 Safe torque off</i> and <i>FA81 Safe torque off 1</i></td> </tr> <tr> <td>1</td> <td>0</td> <td>Faults <i>5091 Safe torque off</i> and <i>FA82 Safe torque off 2</i></td> </tr> <tr> <td>1</td> <td>1</td> <td>(Normal operation)</td> </tr> </tbody> </table>	Inputs		Indication (running or stopped)	IN1	IN2	0	0	Fault <i>5091 Safe torque off</i>	0	1	Faults <i>5091 Safe torque off</i> and <i>FA81 Safe torque off 1</i>	1	0	Faults <i>5091 Safe torque off</i> and <i>FA82 Safe torque off 2</i>	1	1	(Normal operation)	0							
Inputs		Indication (running or stopped)																									
IN1	IN2																										
0	0	Fault <i>5091 Safe torque off</i>																									
0	1	Faults <i>5091 Safe torque off</i> and <i>FA81 Safe torque off 1</i>																									
1	0	Faults <i>5091 Safe torque off</i> and <i>FA82 Safe torque off 2</i>																									
1	1	(Normal operation)																									
	Fault/Warning	<table border="1" data-bbox="339 994 850 1305"> <thead> <tr> <th colspan="2">Inputs</th> <th colspan="2">Indication</th> </tr> <tr> <th>IN1</th> <th>IN2</th> <th>Running</th> <th>Stopped</th> </tr> </thead> <tbody> <tr> <td>0</td> <td>0</td> <td>Fault <i>5091 Safe torque off</i></td> <td>Warning <i>A5A0 Safe torque off</i></td> </tr> <tr> <td>0</td> <td>1</td> <td>Faults <i>5091 Safe torque off</i> and <i>FA81 Safe torque off 1</i></td> <td>Warning <i>A5A0 Safe torque off</i> and fault <i>FA81 Safe torque off 1</i></td> </tr> <tr> <td>1</td> <td>0</td> <td>Faults <i>5091 Safe torque off</i> and <i>FA82 Safe torque off 2</i></td> <td>Warning <i>A5A0 Safe torque off</i> and fault <i>FA82 Safe torque off 2</i></td> </tr> <tr> <td>1</td> <td>1</td> <td colspan="2">(Normal operation)</td> </tr> </tbody> </table>	Inputs		Indication		IN1	IN2	Running	Stopped	0	0	Fault <i>5091 Safe torque off</i>	Warning <i>A5A0 Safe torque off</i>	0	1	Faults <i>5091 Safe torque off</i> and <i>FA81 Safe torque off 1</i>	Warning <i>A5A0 Safe torque off</i> and fault <i>FA81 Safe torque off 1</i>	1	0	Faults <i>5091 Safe torque off</i> and <i>FA82 Safe torque off 2</i>	Warning <i>A5A0 Safe torque off</i> and fault <i>FA82 Safe torque off 2</i>	1	1	(Normal operation)		1
Inputs		Indication																									
IN1	IN2	Running	Stopped																								
0	0	Fault <i>5091 Safe torque off</i>	Warning <i>A5A0 Safe torque off</i>																								
0	1	Faults <i>5091 Safe torque off</i> and <i>FA81 Safe torque off 1</i>	Warning <i>A5A0 Safe torque off</i> and fault <i>FA81 Safe torque off 1</i>																								
1	0	Faults <i>5091 Safe torque off</i> and <i>FA82 Safe torque off 2</i>	Warning <i>A5A0 Safe torque off</i> and fault <i>FA82 Safe torque off 2</i>																								
1	1	(Normal operation)																									

No.	Name/Value	Description	Def/FbEq16																								
	Fault/Event	<table border="1"> <thead> <tr> <th colspan="2">Inputs</th> <th colspan="2">Indication</th> </tr> <tr> <th>IN1</th> <th>IN2</th> <th>Running</th> <th>Stopped</th> </tr> </thead> <tbody> <tr> <td>0</td> <td>0</td> <td>Fault <i>5091 Safe torque off</i></td> <td>Event <i>B5A0 STO event</i></td> </tr> <tr> <td>0</td> <td>1</td> <td>Faults <i>5091 Safe torque off</i> and <i>FA81 Safe torque off 1</i></td> <td>Event <i>B5A0 STO event</i> and fault <i>FA81 Safe torque off 1</i></td> </tr> <tr> <td>1</td> <td>0</td> <td>Faults <i>5091 Safe torque off</i> and <i>FA82 Safe torque off 2</i></td> <td>Event <i>B5A0 STO event</i> and fault <i>FA82 Safe torque off 2</i></td> </tr> <tr> <td>1</td> <td>1</td> <td colspan="2">(Normal operation)</td> </tr> </tbody> </table>	Inputs		Indication		IN1	IN2	Running	Stopped	0	0	Fault <i>5091 Safe torque off</i>	Event <i>B5A0 STO event</i>	0	1	Faults <i>5091 Safe torque off</i> and <i>FA81 Safe torque off 1</i>	Event <i>B5A0 STO event</i> and fault <i>FA81 Safe torque off 1</i>	1	0	Faults <i>5091 Safe torque off</i> and <i>FA82 Safe torque off 2</i>	Event <i>B5A0 STO event</i> and fault <i>FA82 Safe torque off 2</i>	1	1	(Normal operation)		2
Inputs		Indication																									
IN1	IN2	Running	Stopped																								
0	0	Fault <i>5091 Safe torque off</i>	Event <i>B5A0 STO event</i>																								
0	1	Faults <i>5091 Safe torque off</i> and <i>FA81 Safe torque off 1</i>	Event <i>B5A0 STO event</i> and fault <i>FA81 Safe torque off 1</i>																								
1	0	Faults <i>5091 Safe torque off</i> and <i>FA82 Safe torque off 2</i>	Event <i>B5A0 STO event</i> and fault <i>FA82 Safe torque off 2</i>																								
1	1	(Normal operation)																									
	Warning/Warning	<table border="1"> <thead> <tr> <th colspan="2">Inputs</th> <th rowspan="2">Indication (running or stopped)</th> </tr> <tr> <th>IN1</th> <th>IN2</th> </tr> </thead> <tbody> <tr> <td>0</td> <td>0</td> <td>Warning <i>A5A0 Safe torque off</i></td> </tr> <tr> <td>0</td> <td>1</td> <td>Warning <i>A5A0 Safe torque off</i> and fault <i>FA81 Safe torque off 1</i></td> </tr> <tr> <td>1</td> <td>0</td> <td>Warning <i>A5A0 Safe torque off</i> and fault <i>FA82 Safe torque off 2</i></td> </tr> <tr> <td>1</td> <td>1</td> <td>(Normal operation)</td> </tr> </tbody> </table>	Inputs		Indication (running or stopped)	IN1	IN2	0	0	Warning <i>A5A0 Safe torque off</i>	0	1	Warning <i>A5A0 Safe torque off</i> and fault <i>FA81 Safe torque off 1</i>	1	0	Warning <i>A5A0 Safe torque off</i> and fault <i>FA82 Safe torque off 2</i>	1	1	(Normal operation)	3							
Inputs		Indication (running or stopped)																									
IN1	IN2																										
0	0	Warning <i>A5A0 Safe torque off</i>																									
0	1	Warning <i>A5A0 Safe torque off</i> and fault <i>FA81 Safe torque off 1</i>																									
1	0	Warning <i>A5A0 Safe torque off</i> and fault <i>FA82 Safe torque off 2</i>																									
1	1	(Normal operation)																									
	Event/Event	<table border="1"> <thead> <tr> <th colspan="2">Inputs</th> <th rowspan="2">Indication (running or stopped)</th> </tr> <tr> <th>IN1</th> <th>IN2</th> </tr> </thead> <tbody> <tr> <td>0</td> <td>0</td> <td>Event <i>B5A0 STO event</i></td> </tr> <tr> <td>0</td> <td>1</td> <td>Event <i>B5A0 STO event</i> and fault <i>FA81 Safe torque off 1</i></td> </tr> <tr> <td>1</td> <td>0</td> <td>Event <i>B5A0 STO event</i> and fault <i>FA82 Safe torque off 2</i></td> </tr> <tr> <td>1</td> <td>1</td> <td>(Normal operation)</td> </tr> </tbody> </table>	Inputs		Indication (running or stopped)	IN1	IN2	0	0	Event <i>B5A0 STO event</i>	0	1	Event <i>B5A0 STO event</i> and fault <i>FA81 Safe torque off 1</i>	1	0	Event <i>B5A0 STO event</i> and fault <i>FA82 Safe torque off 2</i>	1	1	(Normal operation)	4							
Inputs		Indication (running or stopped)																									
IN1	IN2																										
0	0	Event <i>B5A0 STO event</i>																									
0	1	Event <i>B5A0 STO event</i> and fault <i>FA81 Safe torque off 1</i>																									
1	0	Event <i>B5A0 STO event</i> and fault <i>FA82 Safe torque off 2</i>																									
1	1	(Normal operation)																									
	No indication/No indication	<table border="1"> <thead> <tr> <th colspan="2">Inputs</th> <th rowspan="2">Indication (running or stopped)</th> </tr> <tr> <th>IN1</th> <th>IN2</th> </tr> </thead> <tbody> <tr> <td>0</td> <td>0</td> <td>None</td> </tr> <tr> <td>0</td> <td>1</td> <td>Fault <i>FA81 Safe torque off 1</i></td> </tr> <tr> <td>1</td> <td>0</td> <td>Fault <i>FA82 Safe torque off 2</i></td> </tr> <tr> <td>1</td> <td>1</td> <td>(Normal operation)</td> </tr> </tbody> </table>	Inputs		Indication (running or stopped)	IN1	IN2	0	0	None	0	1	Fault <i>FA81 Safe torque off 1</i>	1	0	Fault <i>FA82 Safe torque off 2</i>	1	1	(Normal operation)	5							
Inputs		Indication (running or stopped)																									
IN1	IN2																										
0	0	None																									
0	1	Fault <i>FA81 Safe torque off 1</i>																									
1	0	Fault <i>FA82 Safe torque off 2</i>																									
1	1	(Normal operation)																									
31.23	<i>Wiring or earth fault</i>	<p>Selects how the drive reacts to incorrect input power and motor cable connection (ie. input power cable is connected to drive motor connection).</p> <p>Note: For ACQ580-31 and ACQ580-34 the default value is <i>No action</i>.</p>	<i>Fault</i>																								
	No action	No action taken.	0																								
	Fault	Drive trips on fault <i>3181 Wiring or earth fault</i> .	1																								

No.	Name/Value	Description	Def/FbEq16
31.24	<i>Stall function</i>	Selects how the drive reacts to a motor stall condition. A stall condition is defined as follows: <ul style="list-style-type: none"> • The drive exceeds the stall current limit (31.25 Stall current limit), and • the output frequency is below the level set by parameter 31.27 Stall frequency limit or the motor speed is below the level set by parameter 31.26 Stall speed limit, and • the conditions above have been true longer than the time set by parameter 31.28 Stall time. 	<i>No action</i>
	No action	None (stall supervision disabled).	0
	Warning	Drive generates warning A780 Motor stall .	1
	Fault	Drive trips on fault 7121 Motor stall .	2
31.25	<i>Stall current limit</i>	Stall current limit in percent of the nominal current of the motor. See parameter 31.24 Stall function .	200.0%
	0.0...1600.0%	Stall current limit.	10 = 1%
31.26	<i>Stall speed limit</i>	Stall speed limit in rpm. See parameter 31.24 Stall function .	150.00 rpm; 180.00 rpm (95.20 b0)
	0.00...10000.00 rpm	Stall speed limit.	See par. 46.01
31.27	<i>Stall frequency limit</i>	Stall frequency limit. See parameter 31.24 Stall function . Note: Setting the limit below 10 Hz is not recommended.	15.00 Hz; 18.00 Hz (95.20 b0)
	0.00...1000.00 Hz	Stall frequency limit.	See par. 46.02
31.28	<i>Stall time</i>	Stall time. See parameter 31.24 Stall function .	20 s
	0...3600 s	Stall time.	1 = 1 s

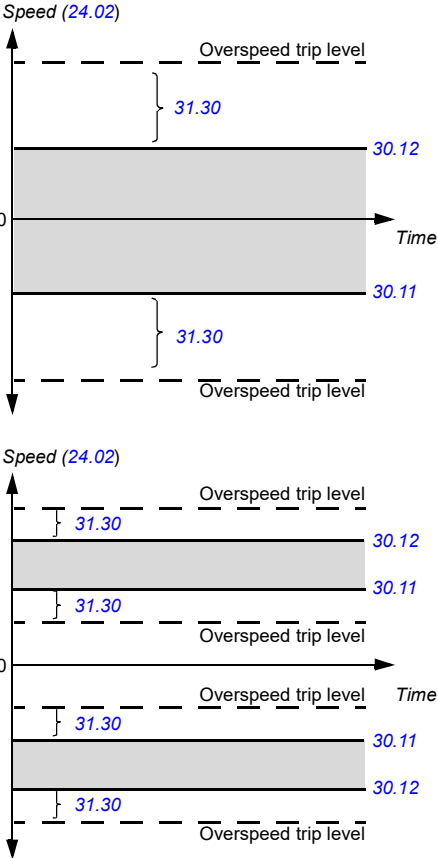
No.	Name/Value	Description	Def/FbEq16
31.30	Overspeed trip margin	<p>Defines, together with 30.11 Minimum speed and 30.12 Maximum speed, the maximum allowed speed of the motor (overspeed protection). If the speed (24.02 Used speed feedback) exceeds the speed limit defined by parameter 30.11 or 30.12 by more than the value of this parameter, the drive trips on the 7310 Overspeed fault.</p> <p>WARNING! This function only supervises the speed in vector motor control mode. The function is not effective in scalar motor control mode.</p> <p>Example: If the maximum speed is 1420 rpm and speed trip margin is 300 rpm, the drive trips at 1720 rpm.</p>  <p>The figure contains two graphs. Both graphs have 'Speed (24.02)' on the vertical axis and 'Time' on the horizontal axis. The origin is marked '0'. The top graph shows a shaded horizontal bar between two levels labeled '30.11' (bottom) and '30.12' (top). A dashed horizontal line above the bar is labeled 'Overspeed trip level'. A vertical bracket between the '30.12' level and the 'Overspeed trip level' is labeled '31.30'. The bottom graph shows a shaded horizontal bar between two levels labeled '30.11' (top) and '30.12' (bottom). A dashed horizontal line below the bar is labeled 'Overspeed trip level'. A vertical bracket between the '30.11' level and the 'Overspeed trip level' is labeled '31.30'.</p>	500.00 rpm
	0.00...10000.00 rpm	Overspeed trip margin.	See par. 46.01

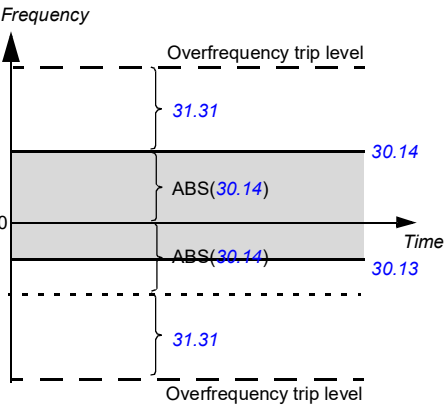
No.	Name/Value	Description	Def/FbEq16
31.31	<i>Frequency trip margin</i>	<p>Defines, together with 30.13 Minimum frequency and 30.14 Maximum frequency, the maximum allowed frequency of the motor (overfrequency protection). The absolute value of this overfrequency trip level is calculated by adding the value of this parameter to the higher of the absolute values of 30.13 Minimum frequency and 30.14 Maximum frequency.</p> <p>If the output frequency (01.06 Output frequency) exceeds the overfrequency trip level (ie. the absolute value of the output frequency exceeds the absolute value of the overfrequency trip level), the drive trips on fault 73F0 Overfrequency.</p> <p>WARNING! This function only supervises the frequency in scalar motor control mode.</p> <p> Frequency</p>  <p>The graph shows Frequency on the vertical axis and Time on the horizontal axis. A dashed horizontal line at the top represents the 'Overfrequency trip level'. A solid horizontal line below it is labeled '30.14'. A shaded rectangular area between the '30.14' line and a lower solid line labeled 'ABS(30.14)' represents the allowed frequency range. Below the 'ABS(30.14)' line is another solid line labeled '30.13'. A dashed horizontal line at the bottom represents the 'Overfrequency trip level' for the lower range. A bracket labeled '31.31' indicates the margin between the top 'Overfrequency trip level' and the '30.14' line. The origin is marked '0'.</p>	15.00 Hz
	0.00...10000.00 Hz	Overfrequency trip margin.	1 = 1 Hz
31.32	<i>Emergency ramp supervision</i>	<p>Parameters 31.32 Emergency ramp supervision and 31.33 Emergency ramp supervision delay, together with the derivative of 24.02 Used speed feedback, provide a supervision function for emergency stop modes Off1 and Off3.</p> <p>The supervision is based on either</p> <ul style="list-style-type: none"> observing the time within which the motor stops, or comparing the actual and expected deceleration rates. <p>If this parameter is set to 0%, the maximum stop time is directly set in parameter 31.33. Otherwise, 31.32 defines the maximum allowed deviation from the expected deceleration rate, which is calculated from parameters 23.12...23.13 (Off1) or 23.23 Emergency stop time (Off3). If the actual deceleration rate (24.02) deviates too much from the expected rate, the drive trips on fault 73B0 Emergency ramp failed, sets bit 8 of 06.17 Drive status word 2, and coasts to a stop.</p> <p>If 31.32 is set to 0% and 31.33 is set to 0 s, the emergency stop ramp supervision is disabled.</p> <p>See also parameter 21.04 Emergency stop mode.</p>	0%
	0...300%	Maximum deviation from expected deceleration rate.	

No.	Name/Value	Description	Def/FbEq16
31.33	<i>Emergency ramp supervision delay</i>	<p>If parameter 31.32 Emergency ramp supervision is set to 0%, this parameter defines the maximum time an emergency stop (mode Off1 or Off3) is allowed to take. If the motor has not stopped when the time elapses, the drive trips on fault 73B0 Emergency ramp failed, sets bit 8 of 06.17 Drive status word 2, and coasts to a stop.</p> <p>If 31.32 is set to a value other than 0%, this parameter defines a delay between the receipt of the emergency stop command and the activation of the supervision. It is recommended to specify a short delay to allow the speed change rate to stabilize.</p>	0 s
	0... 100 s	Maximum ramp-down time, or supervision activation delay.	1 = 1 s
31.35	<i>Main fan fault function</i>	<p>Selects how the drive reacts when a main cooling fan speed problem is detected. For frame sizes R6 or larger only. An event is triggered according to the value of this parameter (fault, warning or no action)</p> <ul style="list-style-type: none"> • if the rotation speed signal from the fan is lower than the measured fan maximum speed (determined during the fan ID run) • if the measured fan maximum speed is lower than the predefined minimum value. 	<i>Fault</i>
	Fault	Drive trips on fault 5080 Fan	0
	Warning	Drive generates warning A581 Fan .	1
	No action	No action taken.	2
31.36	<i>Aux fan fault function</i>	<p>Selects how the drive reacts when an auxiliary fan problem is detected.</p> <p>Certain drive types (especially those protected to IP55) have an auxiliary fan built into the front cover as standard. If it is necessary to operate the drive without the front cover (for example, during commissioning), you can set the parameter to value <i>No action</i> within two minutes from power-up to temporarily suppress the fault or warning. Return the value to <i>Fault</i> or <i>Warning</i> afterwards.</p> <p>On frame sizes R1...R5, the auxiliary fan is attached to connector X10 and on frame sizes R6 and larger to connector X16.</p>	<i>Fault</i>
	Fault	The drive trips on fault 5081 Auxiliary fan broken . The fault is suppressed for two minutes after power-up.	0
	Warning	The drive generates warning A582 Auxiliary fan missing . The warning is suppressed for two minutes after power-up.	1
	No action	No action taken.	2

No.	Name/Value	Description	Def/FbEq16																					
31.40	<i>Disable warning messages</i>	Selects warnings to be suppressed. This parameter is a 16-bit word with each bit corresponding to a warning. Whenever a bit is set to 1, the corresponding warning is suppressed.	0000h																					
<table border="1"> <thead> <tr> <th>Bit</th> <th>Name</th> <th>Description</th> </tr> </thead> <tbody> <tr> <td>0</td> <td>Reserved</td> <td></td> </tr> <tr> <td>1</td> <td>DC link undervoltage</td> <td>1 = Warning <i>A3A2 DC link undervoltage</i> is suppressed.</td> </tr> <tr> <td>2...4</td> <td>Reserved</td> <td></td> </tr> <tr> <td>5</td> <td>Emergency stop off2</td> <td>1 = Warning <i>AFE1 Emergency stop (off2)</i> is suppressed.</td> </tr> <tr> <td>4</td> <td>Emergency stop off1, off3</td> <td>1 = Warning <i>AFE2 Emergency stop (off1 or off3)</i> is suppressed.</td> </tr> <tr> <td>7...15</td> <td>Reserved</td> <td></td> </tr> </tbody> </table>				Bit	Name	Description	0	Reserved		1	DC link undervoltage	1 = Warning <i>A3A2 DC link undervoltage</i> is suppressed.	2...4	Reserved		5	Emergency stop off2	1 = Warning <i>AFE1 Emergency stop (off2)</i> is suppressed.	4	Emergency stop off1, off3	1 = Warning <i>AFE2 Emergency stop (off1 or off3)</i> is suppressed.	7...15	Reserved	
Bit	Name	Description																						
0	Reserved																							
1	DC link undervoltage	1 = Warning <i>A3A2 DC link undervoltage</i> is suppressed.																						
2...4	Reserved																							
5	Emergency stop off2	1 = Warning <i>AFE1 Emergency stop (off2)</i> is suppressed.																						
4	Emergency stop off1, off3	1 = Warning <i>AFE2 Emergency stop (off1 or off3)</i> is suppressed.																						
7...15	Reserved																							
	0000h...FFFFh	Word for disabling warnings.	1 = 1																					
31.50	<i>Cabinet temp warning limit</i>	(Only visible for ACQ580-07). Defines the warning limit for cabinet temperature. When the limit is exceeded, the drive generates warning <i>A4B0 Excess temperature</i> .	65 °C																					
		Cabinet temperature warning limit.	-																					
31.51	<i>Cabinet temp fault limit</i>	(Only visible for ACQ580-07). Defines the fault limit for cabinet temperature. When the limit is exceeded, the drive trips on fault <i>4310 Excess temperature</i> .	75 °C																					
		Cabinet temperature fault limit.	-																					
31.120	<i>LSU earth fault</i>	(Only visible for ACQ580-31 and ACQ580-34). Selects how the supply unit reacts when an earth fault or current unbalance is detected.	<i>Fault</i>																					
	No action	No action taken.	0																					
	Warning	The supply unit generates warning <i>AE02 Earth leakage</i> .	1																					
	Fault	The supply unit trips on fault <i>2E01 Earth leakage</i> .	2																					
31.121	<i>LSU supply phase loss</i>	(Only visible for ACQ580-31 and ACQ580-34). Selects how the supply unit reacts when a supply phase loss is detected.	<i>Fault</i>																					
	No action	No action taken.	0																					
	Fault	The supply unit trips on fault <i>3E00 Input phase loss</i> .	1																					

No.	Name/Value	Description	Def/FbEq16																								
32 Supervision																											
		Configuration of signal supervision functions 1...6. Six values can be chosen to be monitored; a warning or fault is generated whenever predefined limits are exceeded. See also section <i>Diagnostics menu</i> (page 181).																									
32.01	<i>Supervision status</i>	Signal supervision status word. Indicates whether the values monitored by the signal supervision functions are within or outside their respective limits. Note: This word is independent of the drive actions defined by parameters 32.06, 32.16, 32.26, 32.36, 32.46 and 32.56.	0000b																								
<table border="1"> <thead> <tr> <th>Bit</th> <th>Name</th> <th>Description</th> </tr> </thead> <tbody> <tr> <td>0</td> <td>Supervision 1 active</td> <td>1 = Signal selected by 32.07 is outside its limits.</td> </tr> <tr> <td>1</td> <td>Supervision 2 active</td> <td>1 = Signal selected by 32.17 is outside its limits.</td> </tr> <tr> <td>2</td> <td>Supervision 3 active</td> <td>1 = Signal selected by 32.27 is outside its limits.</td> </tr> <tr> <td>3</td> <td>Supervision 4 active</td> <td>1 = Signal selected by 32.37 is outside its limits.</td> </tr> <tr> <td>4</td> <td>Supervision 5 active</td> <td>1 = Signal selected by 32.47 is outside its limits.</td> </tr> <tr> <td>5</td> <td>Supervision 6 active</td> <td>1 = Signal selected by 32.27 is outside its limits.</td> </tr> <tr> <td>6...15</td> <td>Reserved</td> <td></td> </tr> </tbody> </table>				Bit	Name	Description	0	Supervision 1 active	1 = Signal selected by 32.07 is outside its limits.	1	Supervision 2 active	1 = Signal selected by 32.17 is outside its limits.	2	Supervision 3 active	1 = Signal selected by 32.27 is outside its limits.	3	Supervision 4 active	1 = Signal selected by 32.37 is outside its limits.	4	Supervision 5 active	1 = Signal selected by 32.47 is outside its limits.	5	Supervision 6 active	1 = Signal selected by 32.27 is outside its limits.	6...15	Reserved	
Bit	Name	Description																									
0	Supervision 1 active	1 = Signal selected by 32.07 is outside its limits.																									
1	Supervision 2 active	1 = Signal selected by 32.17 is outside its limits.																									
2	Supervision 3 active	1 = Signal selected by 32.27 is outside its limits.																									
3	Supervision 4 active	1 = Signal selected by 32.37 is outside its limits.																									
4	Supervision 5 active	1 = Signal selected by 32.47 is outside its limits.																									
5	Supervision 6 active	1 = Signal selected by 32.27 is outside its limits.																									
6...15	Reserved																										
0000h...FFFFh		Signal supervision status word.	1 = 1																								
32.05	<i>Supervision 1 function</i>	Selects the mode of signal supervision function 1. Determines how the monitored signal (see parameter 32.07) is compared to its lower and upper limits (32.09 and 32.10 respectively). The action to be taken when the condition is fulfilled is selected by 32.06.	<i>Disabled</i>																								
Disabled		Signal supervision 1 not in use.	0																								
Low		Action is taken whenever the signal falls below its lower limit.	1																								
High		Action is taken whenever the signal rises above its upper limit.	2																								
Abs low		Action is taken whenever the absolute value of the signal falls below its (absolute) lower limit.	3																								
Abs high		Action is taken whenever the absolute value of the signal rises above its (absolute) upper limit.	4																								
Both		Action is taken whenever the signal falls below its low limit or rises above its high limit.	5																								
Abs both		Action is taken whenever the absolute value of the signal falls below its (absolute) low limit or rises above its (absolute) high limit.	6																								
Hysteresis		Action is taken whenever the signal rises above the value defined by the upper limit + 0.5 · hysteresis. The action is deactivated when the signal falls below the value defined by the lower limit - 0.5 · hysteresis.	7																								
32.06	<i>Supervision 1 action</i>	Selects whether the drive generates a fault, warning or neither when the value monitored by signal supervision 1 exceeds its limits. Note: This parameter does not affect the status indicated by 32.01 <i>Supervision status</i> .	<i>No action</i>																								
No action		No warning or fault generated.	0																								
Warning		Drive generates warning <i>A8B0 ABB Signal supervision 1</i> .	1																								

No.	Name/Value	Description	Def/FbEq16
	Fault	Drive trips on fault 80B0 Signal supervision 1 .	2
	Fault if running	If running, the drive trips on fault 80B0 Signal supervision 1 .	3
32.07	Supervision 1 signal	Selects the signal to be monitored by signal supervision function 1.	<i>Frequency</i>
	Zero	None.	0
	Speed	01.01 Motor speed used (page 288).	1
	Reserved		2
	Frequency	01.06 Output frequency (page 288).	3
	Current	01.07 Motor current (page 288).	4
	Reserved		5
	Torque	01.10 Motor torque (page 288).	6
	DC voltage	01.11 DC voltage (page 288).	7
	Output power	01.14 Output power (page 289).	8
	AI1	12.11 AI1 actual value (page 321).	9
	AI2	12.21 AI2 actual value (page 323).	10
	Reserved		11...17
	Speed ref ramp in	23.01 Speed ref ramp input (page 370).	18
	Speed ref ramp out	23.02 Speed ref ramp output (page 370).	19
	Speed ref used	24.01 Used speed reference (page 371).	20
	Reserved		21
	Freq ref used	28.02 Frequency ref ramp output (page 377).	22
	Inverter temperature	05.11 Inverter temperature (page 295).	23
	Process PID output	40.01 Process PID output actual (page 437).	24
	Process PID feedback	40.02 Process PID feedback actual (page 437).	25
	Process PID setpoint	40.03 Process PID setpoint actual (page 437).	26
	Process PID deviation	40.04 Process PID deviation actual (page 437).	27
	<i>Other</i>	Source selection (see Terms and abbreviations on page 285).	-
32.08	Supervision 1 filter time	Defines a filter time constant for the signal monitored by signal supervision 1.	0.000 s
	0.000 ... 30.000 s	Signal filter time.	1000 = 1 s
32.09	Supervision 1 low	Defines the lower limit for signal supervision 1.	0.00
	-21474836.00... 21474836.00	Low limit.	
32.10	Supervision 1 high	Defines the upper limit for signal supervision 1.	0.00
	-21474836.00... 21474836.00	Upper limit.	

No.	Name/Value	Description	Def/FbEq16
32.11	<i>Supervision 1 hysteresis</i>	Defines the hysteresis for the signal monitored by signal supervision 1. This parameter applies to all selections for parameter <i>32.05 Supervision 1 function</i> , not just selection Hysteresis (7). Action is taken whenever the signal rises above the value defined by the upper limit + 0.5 · hysteresis. The action is deactivated when the signal falls below the value defined by the lower limit - 0.5 · hysteresis.	0.00
	0.00...100000.00	Hysteresis.	
32.15	<i>Supervision 2 function</i>	Selects the mode of signal supervision function 2. Determines how the monitored signal (see parameter <i>32.17</i>) is compared to its lower and upper limits (<i>32.19</i> and <i>32.20</i> respectively). The action to be taken when the condition is fulfilled is selected by <i>32.16</i> .	<i>Disabled</i>
	Disabled	Signal supervision 2 not in use.	0
	Low	Action is taken whenever the signal falls below its lower limit.	1
	High	Action is taken whenever the signal rises above its upper limit.	2
	Abs low	Action is taken whenever the absolute value of the signal falls below its (absolute) lower limit.	3
	Abs high	Action is taken whenever the absolute value of the signal rises above its (absolute) upper limit.	4
	Both	Action is taken whenever the signal falls below its low limit or rises above its high limit.	5
	Abs both	Action is taken whenever the absolute value of the signal falls below its (absolute) low limit or rises above its (absolute) high limit.	6
	Hysteresis	Action is taken whenever the signal rises above the value defined by the upper limit + 0.5 · hysteresis. The action is deactivated when the signal falls below the value defined by the lower limit - 0.5 · hysteresis.	7
32.16	<i>Supervision 2 action</i>	Selects whether the drive generates a fault, warning or neither when the value monitored by signal supervision 2 exceeds its limits. Note: This parameter does not affect the status indicated by <i>32.01 Supervision status</i> .	<i>No action</i>
	No action	No warning or fault generated.	0
	Warning	Drive generates warning <i>A8B1 ABB Signal supervision 2</i> .	1
	Fault	Drive trips on fault <i>80B1 Signal supervision 2</i> .	2
	Fault if running	If running, the drive trips on fault <i>80B1 Signal supervision 2</i> .	3
32.17	<i>Supervision 2 signal</i>	Selects the signal to be monitored by signal supervision function 2. For the available selections, see parameter <i>32.07 Supervision 1 signal</i> .	<i>Current</i>
32.18	<i>Supervision 2 filter time</i>	Defines a filter time constant for the signal monitored by signal supervision 2.	0.000 s
	0.000 ... 30.000 s	Signal filter time.	1000 = 1 s
32.19	<i>Supervision 2 low</i>	Defines the lower limit for signal supervision 2.	0.00
	-21474836.00... 21474836.00	Low limit.	

No.	Name/Value	Description	Def/FbEq16
32.20	<i>Supervision 2 high</i>	Defines the upper limit for signal supervision 2.	0.00
	-21474836.00... 21474836.00	Upper limit.	
32.21	<i>Supervision 2 hysteresis</i>	Defines the hysteresis for the signal monitored by signal supervision 2. This parameter applies to all selections for parameter 32.15 Supervision 2 function , not just selection Hysteresis (7). Action is taken whenever the signal rises above the value defined by the upper limit + 0.5 · hysteresis. The action is deactivated when the signal falls below the value defined by the lower limit - 0.5 · hysteresis.	0.00
	0.00...100000.00	Hysteresis.	
32.25	<i>Supervision 3 function</i>	Selects the mode of signal supervision function 3. Determines how the monitored signal (see parameter 32.27) is compared to its lower and upper limits (32.29 and 32.30 respectively). The action to be taken when the condition is fulfilled is selected by 32.26 .	<i>Disabled</i>
	Disabled	Signal supervision 3 not in use.	0
	Low	Action is taken whenever the signal falls below its lower limit.	1
	High	Action is taken whenever the signal rises above its upper limit.	2
	Abs low	Action is taken whenever the absolute value of the signal falls below its (absolute) lower limit.	3
	Abs high	Action is taken whenever the absolute value of the signal rises above its (absolute) upper limit.	4
	Both	Action is taken whenever the signal falls below its low limit or rises above its high limit.	5
	Abs both	Action is taken whenever the absolute value of the signal falls below its (absolute) low limit or rises above its (absolute) high limit.	6
	Hysteresis	Action is taken whenever the signal rises above the value defined by the upper limit + 0.5 · hysteresis. The action is deactivated when the signal falls below the value defined by the lower limit - 0.5 · hysteresis.	7
32.26	<i>Supervision 3 action</i>	Selects whether the drive generates a fault, warning or neither when the value monitored by signal supervision 3 exceeds its limits. Note: This parameter does not affect the status indicated by 32.01 Supervision status .	<i>No action</i>
	No action	No warning or fault generated.	0
	Warning	Drive generates warning A8B2 ABB Signal supervision 3 .	1
	Fault	Drive trips on fault 80B2 Signal supervision 3 .	2
	Fault if running	If running, the drive trips on fault 80B2 Signal supervision 3 .	3
32.27	<i>Supervision 3 signal</i>	Selects the signal to be monitored by signal supervision function 3. For the available selections, see parameter 32.07 Supervision 1 signal .	<i>Torque</i>
32.28	<i>Supervision 3 filter time</i>	Defines a filter time constant for the signal monitored by signal supervision 3.	0.000 s
	0.000 ... 30.000 s	Signal filter time.	1000 = 1 s

No.	Name/Value	Description	Def/FbEq16
32.29	<i>Supervision 3 low</i>	Defines the lower limit for signal supervision 3.	0.00
	-21474836.00... 21474836.00	Low limit.	
32.30	<i>Supervision 3 high</i>	Defines the upper limit for signal supervision 3.	0.00
	-21474836.00... 21474836.00	Upper limit.	
32.31	<i>Supervision 3 hysteresis</i>	Defines the hysteresis for the signal monitored by signal supervision 3. This parameter applies to all selections for parameter 32.25 Supervision 3 function , not just selection Hysteresis (7). Action is taken whenever the signal rises above the value defined by the upper limit + 0.5 · hysteresis. The action is deactivated when the signal falls below the value defined by the lower limit - 0.5 · hysteresis.	0.00
	0.00...100000.00	Hysteresis.	
32.35	<i>Supervision 4 function</i>	Selects the mode of signal supervision function 4. Determines how the monitored signal (see parameter 32.37) is compared to its lower and upper limits (32.39 and 32.30 respectively). The action to be taken when the condition is fulfilled is selected by 32.36 .	<i>Disabled</i>
	Disabled	Signal supervision 4 not in use.	0
	Low	Action is taken whenever the signal falls below its lower limit.	1
	High	Action is taken whenever the signal rises above its upper limit.	2
	Abs low	Action is taken whenever the absolute value of the signal falls below its (absolute) lower limit.	3
	Abs high	Action is taken whenever the absolute value of the signal rises above its (absolute) upper limit.	4
	Both	Action is taken whenever the signal falls below its low limit or rises above its high limit.	5
	Abs both	Action is taken whenever the absolute value of the signal falls below its (absolute) low limit or rises above its (absolute) high limit.	6
	Hysteresis	Action is taken whenever the signal rises above the value defined by the upper limit + 0.5 · hysteresis. The action is deactivated when the signal falls below the value defined by the lower limit - 0.5 · hysteresis.	7
32.36	<i>Supervision 4 action</i>	Selects whether the drive generates a fault, warning or neither when the value monitored by signal supervision 4 exceeds its limits. Note: This parameter does not affect the status indicated by 32.01 Supervision status .	<i>No action</i>
	No action	No warning or fault generated.	0
	Warning	Drive generates warning A8B3 ABB Signal supervision 4 .	1
	Fault	Drive trips on fault 80B3 Signal supervision 4 .	2
	Fault if running	If running, the drive trips on fault 80B3 Signal supervision 4 .	3
32.37	<i>Supervision 4 signal</i>	Selects the signal to be monitored by signal supervision function 4. For the available selections, see parameter 32.07 Supervision 1 signal .	<i>Zero</i>

No.	Name/Value	Description	Def/FbEq16
32.38	<i>Supervision 4 filter time</i>	Defines a filter time constant for the signal monitored by signal supervision 4.	0.000 s
	0.000 ... 30.000 s	Signal filter time.	1000 = 1 s
32.39	<i>Supervision 4 low</i>	Defines the lower limit for signal supervision 4.	0.00
	-21474836.00... 21474836.00	Low limit.	
32.40	<i>Supervision 4 high</i>	Defines the upper limit for signal supervision 4.	0.00
	-21474836.00... 21474836.00	Upper limit.	
32.41	<i>Supervision 4 hysteresis</i>	Defines the hysteresis for the signal monitored by signal supervision 4. This parameter applies to all selections for parameter 32.35 Supervision 4 function , not just selection Hysteresis (7). Action is taken whenever the signal rises above the value defined by the upper limit + 0.5 · hysteresis. The action is deactivated when the signal falls below the value defined by the lower limit - 0.5 · hysteresis.	0.00
	0.00...100000.00	Hysteresis.	
32.45	<i>Supervision 5 function</i>	Selects the mode of signal supervision function 5. Determines how the monitored signal (see parameter 32.47) is compared to its lower and upper limits (32.49 and 32.40 respectively). The action to be taken when the condition is fulfilled is selected by 32.46 .	<i>Disabled</i>
	Disabled	Signal supervision 5 not in use.	0
	Low	Action is taken whenever the signal falls below its lower limit.	1
	High	Action is taken whenever the signal rises above its upper limit.	2
	Abs low	Action is taken whenever the absolute value of the signal falls below its (absolute) lower limit.	3
	Abs high	Action is taken whenever the absolute value of the signal rises above its (absolute) upper limit.	4
	Both	Action is taken whenever the signal falls below its low limit or rises above its high limit.	5
	Abs both	Action is taken whenever the absolute value of the signal falls below its (absolute) low limit or rises above its (absolute) high limit.	6
	Hysteresis	Action is taken whenever the signal rises above the value defined by the upper limit + 0.5 · hysteresis. The action is deactivated when the signal falls below the value defined by the lower limit - 0.5 · hysteresis.	7
32.46	<i>Supervision 5 action</i>	Selects whether the drive generates a fault, warning or neither when the value monitored by signal supervision 5 exceeds its limits. Note: This parameter does not affect the status indicated by 32.01 Supervision status .	<i>No action</i>
	No action	No warning or fault generated.	0
	Warning	Drive generates warning A8B4 ABB Signal supervision 5 .	1
	Fault	Drive trips on fault 80B4 Signal supervision 5 .	2
	Fault if running	If running, the drive trips on fault 80B4 Signal supervision 5 .	3

No.	Name/Value	Description	Def/FbEq16
32.47	<i>Supervision 5 signal</i>	Selects the signal to be monitored by signal supervision function 5. For the available selections, see parameter 32.07 Supervision 1 signal .	<i>Zero</i>
32.48	<i>Supervision 5 filter time</i>	Defines a filter time constant for the signal monitored by signal supervision 5.	0.000 s
	0.000 ... 30.000 s	Signal filter time.	1000 = 1 s
32.49	<i>Supervision 5 low</i>	Defines the lower limit for signal supervision 5.	0.00
	-21474836.00... 21474836.00	Low limit.	
32.50	<i>Supervision 5 high</i>	Defines the upper limit for signal supervision 5.	0.00
	-21474836.00... 21474836.00	Upper limit.	
32.51	<i>Supervision 5 hysteresis</i>	Defines the hysteresis for the signal monitored by signal supervision 5. This parameter applies to all selections for parameter 32.45 Supervision 5 function , not just selection Hysteresis (7). Action is taken whenever the signal rises above the value defined by the upper limit + 0.5 · hysteresis. The action is deactivated when the signal falls below the value defined by the lower limit - 0.5 · hysteresis.	0.00
	0.00...100000.00	Hysteresis.	
32.55	<i>Supervision 6 function</i>	Selects the mode of signal supervision function 6. Determines how the monitored signal (see parameter 32.57) is compared to its lower and upper limits (32.59 and 32.50 respectively). The action to be taken when the condition is fulfilled is selected by 32.56 .	<i>Disabled</i>
	Disabled	Signal supervision 6 not in use.	0
	Low	Action is taken whenever the signal falls below its lower limit.	1
	High	Action is taken whenever the signal rises above its upper limit.	2
	Abs low	Action is taken whenever the absolute value of the signal falls below its (absolute) lower limit.	3
	Abs high	Action is taken whenever the absolute value of the signal rises above its (absolute) upper limit.	4
	Both	Action is taken whenever the signal falls below its low limit or rises above its high limit.	5
	Abs both	Action is taken whenever the absolute value of the signal falls below its (absolute) low limit or rises above its (absolute) high limit.	6
	Hysteresis	Action is taken whenever the signal rises above the value defined by the upper limit + 0.5 · hysteresis. The action is deactivated when the signal falls below the value defined by the lower limit - 0.5 · hysteresis.	7
32.56	<i>Supervision 6 action</i>	Selects whether the drive generates a fault, warning or neither when the value monitored by signal supervision 6 exceeds its limits. Note: This parameter does not affect the status indicated by 32.01 Supervision status .	<i>No action</i>
	No action	No warning or fault generated.	0
	Warning	Drive generates warning A8B5 ABB Signal supervision 6 .	1

No.	Name/Value	Description	Def/FbEq16
	Fault	Drive trips on fault 80B5 Signal supervision 6 .	2
	Fault if running	If running, the drive trips on fault 80B5 Signal supervision 6 .	3
32.57	Supervision 6 signal	Selects the signal to be monitored by signal supervision function 6. For the available selections, see parameter 32.07 Supervision 1 signal .	Zero
32.58	Supervision 6 filter time	Defines a filter time constant for the signal monitored by signal supervision 6.	0.000 s
	0.000 ... 30.000 s	Signal filter time.	1000 = 1 s
32.59	Supervision 6 low	Defines the lower limit for signal supervision 6.	0.00
	-21474836.00... 21474836.00	Low limit.	
32.60	Supervision 6 high	Defines the upper limit for signal supervision 6.	0.00
	-21474836.00... 21474836.00	Upper limit.	
32.61	Supervision 6 hysteresis	Defines the hysteresis for the signal monitored by signal supervision 6. This parameter applies to all selections for parameter 32.55 Supervision 6 function , not just selection Hysteresis (7). Action is taken whenever the signal rises above the value defined by the upper limit + 0.5 · hysteresis. The action is deactivated when the signal falls below the value defined by the lower limit - 0.5 · hysteresis.	0.00
	0.00...100000.00	Hysteresis.	

34 Timed functions		Configuration of the timed functions. See section Timed functions on page 133 .																
34.01	Timed functions status	Status of the combined timers. The status of a combined timer is the logical OR of all timers connected to it. This parameter is read-only.	-															
<table border="1"> <thead> <tr> <th>Bit</th> <th>Name</th> <th>Description</th> </tr> </thead> <tbody> <tr> <td>0</td> <td>Timed function 1</td> <td>1 = Active.</td> </tr> <tr> <td>1</td> <td>Timed function 2</td> <td>1 = Active.</td> </tr> <tr> <td>2</td> <td>Timed function 3</td> <td>1 = Active.</td> </tr> <tr> <td>3...15</td> <td>Reserved</td> <td></td> </tr> </tbody> </table>				Bit	Name	Description	0	Timed function 1	1 = Active.	1	Timed function 2	1 = Active.	2	Timed function 3	1 = Active.	3...15	Reserved	
Bit	Name	Description																
0	Timed function 1	1 = Active.																
1	Timed function 2	1 = Active.																
2	Timed function 3	1 = Active.																
3...15	Reserved																	
	0000h...FFFFh	Status of combined timers 1...3.	1 = 1															

No.	Name/Value	Description	Def/FbEq16																																										
34.02	<i>Timer status</i>	Status of timers 1...12. This parameter is read-only.	-																																										
<table border="1"> <thead> <tr> <th>Bit</th> <th>Name</th> <th>Description</th> </tr> </thead> <tbody> <tr><td>0</td><td>Timer 1</td><td>1 = Active.</td></tr> <tr><td>1</td><td>Timer 2</td><td>1 = Active.</td></tr> <tr><td>2</td><td>Timer 3</td><td>1 = Active.</td></tr> <tr><td>3</td><td>Timer 4</td><td>1 = Active.</td></tr> <tr><td>4</td><td>Timer 5</td><td>1 = Active.</td></tr> <tr><td>5</td><td>Timer 6</td><td>1 = Active.</td></tr> <tr><td>6</td><td>Timer 7</td><td>1 = Active.</td></tr> <tr><td>7</td><td>Timer 8</td><td>1 = Active.</td></tr> <tr><td>8</td><td>Timer 9</td><td>1 = Active.</td></tr> <tr><td>9</td><td>Timer 10</td><td>1 = Active.</td></tr> <tr><td>10</td><td>Timer 11</td><td>1 = Active.</td></tr> <tr><td>11</td><td>Timer 12</td><td>1 = Active.</td></tr> <tr><td>12...15</td><td>Reserved</td><td></td></tr> </tbody> </table>				Bit	Name	Description	0	Timer 1	1 = Active.	1	Timer 2	1 = Active.	2	Timer 3	1 = Active.	3	Timer 4	1 = Active.	4	Timer 5	1 = Active.	5	Timer 6	1 = Active.	6	Timer 7	1 = Active.	7	Timer 8	1 = Active.	8	Timer 9	1 = Active.	9	Timer 10	1 = Active.	10	Timer 11	1 = Active.	11	Timer 12	1 = Active.	12...15	Reserved	
Bit	Name	Description																																											
0	Timer 1	1 = Active.																																											
1	Timer 2	1 = Active.																																											
2	Timer 3	1 = Active.																																											
3	Timer 4	1 = Active.																																											
4	Timer 5	1 = Active.																																											
5	Timer 6	1 = Active.																																											
6	Timer 7	1 = Active.																																											
7	Timer 8	1 = Active.																																											
8	Timer 9	1 = Active.																																											
9	Timer 10	1 = Active.																																											
10	Timer 11	1 = Active.																																											
11	Timer 12	1 = Active.																																											
12...15	Reserved																																												
	0000h...FFFFh	Timer status.	1 = 1																																										
34.04	<i>Season/exception day status</i>	Status of seasons 1...4, exception weekday and exception holiday. Only one season can be active at a time. A day can be a workday and a holiday at the same time. This parameter is read-only.	-																																										
<table border="1"> <thead> <tr> <th>Bit</th> <th>Name</th> <th>Description</th> </tr> </thead> <tbody> <tr><td>0</td><td>Season 1</td><td>1 = Active.</td></tr> <tr><td>1</td><td>Season 2</td><td>1 = Active.</td></tr> <tr><td>2</td><td>Season 3</td><td>1 = Active.</td></tr> <tr><td>3</td><td>Season 4</td><td>1 = Active.</td></tr> <tr><td>4...9</td><td>Reserved</td><td></td></tr> <tr><td>10</td><td>Exception weekday</td><td>1 = Active.</td></tr> <tr><td>11</td><td>Exception holiday</td><td>1 = Active.</td></tr> <tr><td>12...15</td><td>Reserved</td><td></td></tr> </tbody> </table>				Bit	Name	Description	0	Season 1	1 = Active.	1	Season 2	1 = Active.	2	Season 3	1 = Active.	3	Season 4	1 = Active.	4...9	Reserved		10	Exception weekday	1 = Active.	11	Exception holiday	1 = Active.	12...15	Reserved																
Bit	Name	Description																																											
0	Season 1	1 = Active.																																											
1	Season 2	1 = Active.																																											
2	Season 3	1 = Active.																																											
3	Season 4	1 = Active.																																											
4...9	Reserved																																												
10	Exception weekday	1 = Active.																																											
11	Exception holiday	1 = Active.																																											
12...15	Reserved																																												
	0000h...FFFFh	Status of the seasons and exception weekday and holiday.	1 = 1																																										
34.10	<i>Timed functions enable</i>	Selects the source for the timed functions enable signal. 0 = Disabled. 1 = Enabled.	<i>Disabled</i>																																										
	Disabled	0.	0																																										
	Enabled	1.	1																																										
	DI1	Digital input DI1 (<i>10.02 DI delayed status</i> , bit 0).	2																																										
	DI2	Digital input DI2 (<i>10.02 DI delayed status</i> , bit 1).	3																																										
	DI3	Digital input DI3 (<i>10.02 DI delayed status</i> , bit 2).	4																																										
	DI4	Digital input DI4 (<i>10.02 DI delayed status</i> , bit 3).	5																																										
	DI5	Digital input DI5 (<i>10.02 DI delayed status</i> , bit 4).	6																																										
	DI6	Digital input DI6 (<i>10.02 DI delayed status</i> , bit 5).	7																																										

No.	Name/Value	Description	Def/FbEq16
	<i>Other [bit]</i>	Source selection (see Terms and abbreviations on page 285).	-
34.11	<i>Timer 1 configuration</i>	Defines when timer 1 is active.	0000 0111 1000 0000b

Bit	Name	Description
0	Monday	1 = Monday is an active start day.
1	Tuesday	1 = Tuesday is an active start day.
2	Wednesday	1 = Wednesday is an active start day.
3	Thursday	1 = Thursday is an active start day.
4	Friday	1 = Friday is an active start day.
5	Saturday	1 = Saturday is an active start day.
6	Sunday	1 = Sunday is an active start day.
7	Season 1	1 = Timer is active in season 1.
8	Season 2	1 = Timer is active in season 2.
9	Season 3	1 = Timer is active in season 3.
10	Season 4	1 = Timer is active in season 4.
11	Exceptions	<p>0 = Exceptions days are disabled. The timer follows only weekday and season settings (bits 0...10 in the timer configuration) and the start time and duration of the timer (see 34.12 and 34.13).</p> <p>Exception day settings, parameters 34.70...34.90, do not have any effect on this timer.</p> <p>1 = Exception days are enabled. The timer is active during the weekdays and seasons defined with bits 0...10 and the times defined by 34.12 and 34.13.</p> <p>In addition, the timer is active during the exception days defined with bit 12, bit 13 and parameters 34.70...34.90. If bit 12 and bit 13 are both zero, the timer is inactive during the exception days.</p>
12	Holidays	<p>This bit has no effect unless bit 11 = 1 (Exceptions days are enabled).</p> <p>When bits 11 and 12 are both 1, the timer is active during the weekdays and seasons defined with bits 0...10 and times defined by parameters 34.12 and 34.13.</p> <p>In addition, the timer is active when the ongoing day is defined as Exception day Holiday by parameters 34.70...34.90 and the current time matches with the time range defined by 34.12 and 34.13. During Exception days, weekday and season bits are ignored.</p>
13	Workdays	<p>This bit has no effect unless bit 11 = 1 (Exceptions enabled).</p> <p>When bits 11 and 13 are both 1, the Timer is active during the weekdays and seasons defined with bits 0...10 and the times defined by parameters 34.12 and 34.13.</p> <p>In addition, the timer is active when the ongoing day is defined as Exception day Workday by parameters 34.70...34.90 and the current time matches with the time range defined by 34.12 and 34.13. During Exception days, weekday and season bits are ignored.</p>
14...15	Reserved	

No.	Name/Value	Description	Def/FbEq16											
Examples of how the timer configuration defines when the Timer is active are shown below.														
Bits of parameter 34.11 Timer 1 configuration														
Monday	Tuesday	Wednesday	Thursday	Friday	Saturday	Sunday	Season1	Season2	Season3	Season4	Exceptions	Holidays	Workdays	
1	1	1	1	1	1	1	1	1	1	1	0	0	0	Example 1: Timer is active during the times of the day defined by other parameters <u>every Weekday</u> and <u>every Season</u> . Exception day settings (34.70...34.90) do not have any effect on the Timer.
1	1	1	1	1	0	0	1	1	1	1	0	0	0	Example 2: Timer is active during the times of the day defined by other parameters from <u>Mon to Fri</u> , every Season. Exception day settings (34.70...34.90) do not have any effect on the Timer.
1	1	1	1	1	0	0	0	0	1	0	0	0	0	Example 3: Timer is active during the times of the day defined by other parameters from Mon to Fri, <u>only during Season 3</u> (can be configured as, eg, summer). Exception day settings (34.70...34.90) do not have any effect on the Timer.
1	1	1	1	1	0	0	1	1	1	1	1	1	0	Example 4: Timer is active during the times of the day defined by other parameters from Mon to Fri, every Season. In addition, the Timer is active <u>every Exception day, Holidays, regardless what is the day or season</u> .
1	0	1	0	1	0	1	1	1	0	0	1	0	1	Example 5: Timer is active during the times of the day defined by other parameters on Mon, Wed, Fri and Sun, during Season1 and Season 2. In addition, the Timer is active <u>every Exception day, Workdays, regardless what is the day or season</u> .
1	1	1	1	1	1	1	1	1	1	1	1	0	0	Example 6: Timer is active during the times of the day defined by other parameters every Weekday and every Season. The Timer is <u>inactive during all Exception days</u> .
0000h...FFFFh	Configuration of timer 1.	1 = 1												
34.12 Timer 1 start time	Defines the daily start time of timer 1. The time can be changed in second steps. The timer can be started at an other time than the start time. For example, if the timer's duration is more than one day and the active session starts during the time, the timer is started at 00:00 and stopped when there is no duration left.	00:00:00												
00:00:00...23:59:59	Daily start time of the timer.													

No.	Name/Value	Description	Def/FbEq16
34.13	<i>Timer 1 duration</i>	Defines the duration of timer 1. The duration can be changed in minute steps. The duration can extend over the change of the day but if an exception day becomes active, the period is interrupted at midnight. In the same way the period started on an exception day stays active only until the end of the day, even if the duration is longer. The timer will continue after a break if there is duration left.	00 00:00
	00 00:00...07 00:00	Timer duration.	1 = 1 min
34.14	<i>Timer 2 configuration</i>	See 34.11 <i>Timer 1 configuration</i> .	0000 0111 1000 0000b
34.15	<i>Timer 2 start time</i>	See 34.12 <i>Timer 1 start time</i> .	00:00:00
34.16	<i>Timer 2 duration</i>	See 34.13 <i>Timer 1 duration</i> .	00 00:00
34.17	<i>Timer 3 configuration</i>	See 34.11 <i>Timer 1 configuration</i> .	0000 0111 1000 0000b
34.18	<i>Timer 3 start time</i>	See 34.12 <i>Timer 1 start time</i> .	00:00:00
34.19	<i>Timer 3 duration</i>	See 34.13 <i>Timer 1 duration</i> .	00 00:00
34.20	<i>Timer 4 configuration</i>	See 34.11 <i>Timer 1 configuration</i> .	0000 0111 1000 0000b
34.21	<i>Timer 4 start time</i>	See 34.12 <i>Timer 1 start time</i> .	00:00:00
34.22	<i>Timer 4 duration</i>	See 34.13 <i>Timer 1 duration</i> .	00 00:00
34.23	<i>Timer 5 configuration</i>	See 34.11 <i>Timer 1 configuration</i> .	0000 0111 1000 0000b
34.24	<i>Timer 5 start time</i>	See 34.12 <i>Timer 1 start time</i> .	00:00:00
34.25	<i>Timer 5 duration</i>	See 34.13 <i>Timer 1 duration</i> .	00 00:00
34.26	<i>Timer 6 configuration</i>	See 34.11 <i>Timer 1 configuration</i> .	0000 0111 1000 0000b
34.27	<i>Timer 6 start time</i>	See 34.12 <i>Timer 1 start time</i> .	00:00:00
34.28	<i>Timer 6 duration</i>	See 34.13 <i>Timer 1 duration</i> .	00 00:00
34.29	<i>Timer 7 configuration</i>	See 34.11 <i>Timer 1 configuration</i> .	0000 0111 1000 0000b
34.30	<i>Timer 7 start time</i>	See 34.12 <i>Timer 1 start time</i> .	00:00:00
34.31	<i>Timer 7 duration</i>	See 34.13 <i>Timer 1 duration</i> .	00 00:00
34.32	<i>Timer 8 configuration</i>	See 34.11 <i>Timer 1 configuration</i> .	0000 0111 1000 0000b
34.33	<i>Timer 8 start time</i>	See 34.12 <i>Timer 1 start time</i> .	00:00:00
34.34	<i>Timer 8 duration</i>	See 34.13 <i>Timer 1 duration</i> .	00 00:00
34.35	<i>Timer 9 configuration</i>	See 34.11 <i>Timer 1 configuration</i> .	0000 0111 1000 0000b
34.36	<i>Timer 9 start time</i>	See 34.12 <i>Timer 1 start time</i> .	00:00:00
34.37	<i>Timer 9 duration</i>	See 34.13 <i>Timer 1 duration</i> .	00 00:00
34.38	<i>Timer 10 configuration</i>	See 34.11 <i>Timer 1 configuration</i> .	0000 0111 1000 0000b
34.39	<i>Timer 10 start time</i>	See 34.12 <i>Timer 1 start time</i> .	00:00:00
34.40	<i>Timer 10 duration</i>	See 34.13 <i>Timer 1 duration</i> .	00 00:00

No.	Name/Value	Description	Def/FbEq16
34.41	Timer 11 configuration	See 34.11 Timer 1 configuration .	0000 0111 1000 0000b
34.42	Timer 11 start time	See 34.12 Timer 1 start time .	00:00:00
34.43	Timer 11 duration	See 34.13 Timer 1 duration .	00 00:00
34.44	Timer 12 configuration	See 34.11 Timer 1 configuration .	0000 0111 1000 0000b
34.45	Timer 12 start time	See 34.12 Timer 1 start time .	00:00:00
34.46	Timer 12 duration	See 34.13 Timer 1 duration .	00 00:00
34.60	Season 1 start date	Defines the start date of season 1 in format dd.mm, where dd is the number of the day and mm is the number of the month. The season changes at midnight. One season can be active at a time. Timers are started on exception days even if they are not inside the active season. The season start dates (1...4) must be given in increasing order to use all seasons. The default value is interpreted that the season is not configured. If the season start dates are not in increasing order and the value is something else than the default value, a season configuration warning is given.	01.01.
	01.01...31.12	Season start date.	-
34.61	Season 2 start date	Defines the start date of season 2. See 34.60 Season 1 start date .	01.01.
34.62	Season 3 start date	Defines the start date of season 3. See 34.60 Season 1 start date .	01.01.
34.63	Season 4 start date	Defines the start date of season 4. See 34.60 Season 1 start date .	01.01.
34.70	Number of active exceptions	Defines how many of the exceptions are active by specifying the last active one. All preceding exceptions are active. Exceptions 1...3 are periods (duration can be defined) and exceptions 4...16 are days (duration is always 24 hours). Example: If the value is 4, exceptions 1...4 are active, and exceptions 5...16 are not active.	3
	0...16	Number of active exception periods or days.	1 = 1

No.	Name/Value	Description	Def/FbEq16																																																			
34.71	<i>Exception types</i>	Defines the types of exceptions 1...16 as workday or holiday. Exceptions 1...3 are periods (duration can be defined) and exceptions 4...16 are days (duration is always 24 hours).	0000 0000 0000 0000b																																																			
<table border="1"> <thead> <tr> <th>Bit</th> <th>Name</th> <th>Description</th> </tr> </thead> <tbody> <tr><td>0</td><td>Exception 1</td><td>0 = Workday. 1 = Holiday</td></tr> <tr><td>1</td><td>Exception 2</td><td>0 = Workday. 1 = Holiday</td></tr> <tr><td>2</td><td>Exception 3</td><td>0 = Workday. 1 = Holiday</td></tr> <tr><td>3</td><td>Exception 4</td><td>0 = Workday. 1 = Holiday</td></tr> <tr><td>4</td><td>Exception 5</td><td>0 = Workday. 1 = Holiday</td></tr> <tr><td>5</td><td>Exception 6</td><td>0 = Workday. 1 = Holiday</td></tr> <tr><td>6</td><td>Exception 7</td><td>0 = Workday. 1 = Holiday</td></tr> <tr><td>7</td><td>Exception 8</td><td>0 = Workday. 1 = Holiday</td></tr> <tr><td>8</td><td>Exception 9</td><td>0 = Workday. 1 = Holiday</td></tr> <tr><td>9</td><td>Exception 10</td><td>0 = Workday. 1 = Holiday</td></tr> <tr><td>10</td><td>Exception 11</td><td>0 = Workday. 1 = Holiday</td></tr> <tr><td>11</td><td>Exception 12</td><td>0 = Workday. 1 = Holiday</td></tr> <tr><td>12</td><td>Exception 13</td><td>0 = Workday. 1 = Holiday</td></tr> <tr><td>13</td><td>Exception 14</td><td>0 = Workday. 1 = Holiday</td></tr> <tr><td>14</td><td>Exception 15</td><td>0 = Workday. 1 = Holiday</td></tr> <tr><td>15</td><td>Exception 16</td><td>0 = Workday. 1 = Holiday</td></tr> </tbody> </table>				Bit	Name	Description	0	Exception 1	0 = Workday. 1 = Holiday	1	Exception 2	0 = Workday. 1 = Holiday	2	Exception 3	0 = Workday. 1 = Holiday	3	Exception 4	0 = Workday. 1 = Holiday	4	Exception 5	0 = Workday. 1 = Holiday	5	Exception 6	0 = Workday. 1 = Holiday	6	Exception 7	0 = Workday. 1 = Holiday	7	Exception 8	0 = Workday. 1 = Holiday	8	Exception 9	0 = Workday. 1 = Holiday	9	Exception 10	0 = Workday. 1 = Holiday	10	Exception 11	0 = Workday. 1 = Holiday	11	Exception 12	0 = Workday. 1 = Holiday	12	Exception 13	0 = Workday. 1 = Holiday	13	Exception 14	0 = Workday. 1 = Holiday	14	Exception 15	0 = Workday. 1 = Holiday	15	Exception 16	0 = Workday. 1 = Holiday
Bit	Name	Description																																																				
0	Exception 1	0 = Workday. 1 = Holiday																																																				
1	Exception 2	0 = Workday. 1 = Holiday																																																				
2	Exception 3	0 = Workday. 1 = Holiday																																																				
3	Exception 4	0 = Workday. 1 = Holiday																																																				
4	Exception 5	0 = Workday. 1 = Holiday																																																				
5	Exception 6	0 = Workday. 1 = Holiday																																																				
6	Exception 7	0 = Workday. 1 = Holiday																																																				
7	Exception 8	0 = Workday. 1 = Holiday																																																				
8	Exception 9	0 = Workday. 1 = Holiday																																																				
9	Exception 10	0 = Workday. 1 = Holiday																																																				
10	Exception 11	0 = Workday. 1 = Holiday																																																				
11	Exception 12	0 = Workday. 1 = Holiday																																																				
12	Exception 13	0 = Workday. 1 = Holiday																																																				
13	Exception 14	0 = Workday. 1 = Holiday																																																				
14	Exception 15	0 = Workday. 1 = Holiday																																																				
15	Exception 16	0 = Workday. 1 = Holiday																																																				
	0000h...FFFFh	Types of exception period or days.	1 = 1																																																			
34.72	<i>Exception 1 start</i>	Defines the start date of the exception period in format dd.mm, where dd is the number of the day and mm is the number of the month. The timer started on an exception day is always stopped at 23:59:59 even if it has duration left. The same date can be configured to be holiday and workday. The date is active if any of exception days are active.	01.01.																																																			
	01.01....31.12.	Start date of exception period 1.	-																																																			
34.73	<i>Exception 1 length</i>	Defines the length of the exception period in days. Exception period is handled the same as a number of consecutive exception days.	0 d																																																			
	0...60 d	Length of exception period 1.	1 = 1 d																																																			
34.74	<i>Exception 2 start</i>	See 34.72 <i>Exception 1 start</i> .	01.01.																																																			
34.75	<i>Exception 2 length</i>	See 34.73 <i>Exception 1 length</i> .	0 d																																																			
34.76	<i>Exception 3 start</i>	See 34.72 <i>Exception 1 start</i> .	01.01.																																																			
34.77	<i>Exception 3 length</i>	See 34.73 <i>Exception 1 length</i> .	0 d																																																			
34.78	<i>Exception day 4</i>	Defines the date of exception day 4.	01.01.																																																			
	01.01....31.12.	Start date of exception day 4. The timer started on an exception day is always stopped at 23:59:59 even if it has duration left.	-																																																			
34.79	<i>Exception day 5</i>	See 34.79 <i>Exception day 4</i> .	01.01																																																			
34.80	<i>Exception day 6</i>	See 34.79 <i>Exception day 4</i> .	01.01																																																			
34.81	<i>Exception day 7</i>	See 34.79 <i>Exception day 4</i> .	01.01																																																			
34.82	<i>Exception day 8</i>	See 34.79 <i>Exception day 4</i> .	01.01																																																			

No.	Name/Value	Description	Def/FbEq16																																										
34.83	<i>Exception day 9</i>	See 34.79 <i>Exception day 4</i> .	01.01																																										
34.84	<i>Exception day 10</i>	See 34.79 <i>Exception day 4</i> .	01.01																																										
34.85	<i>Exception day 11</i>	See 34.79 <i>Exception day 4</i> .	01.01																																										
34.86	<i>Exception day 12</i>	See 34.79 <i>Exception day 4</i> .	01.01																																										
34.87	<i>Exception day 13</i>	See 34.79 <i>Exception day 4</i> .	01.01																																										
34.88	<i>Exception day 14</i>	See 34.79 <i>Exception day 4</i> .	01.01																																										
34.89	<i>Exception day 15</i>	See 34.79 <i>Exception day 4</i> .	01.01																																										
34.90	<i>Exception day 16</i>	See 34.79 <i>Exception day 4</i> .	01.01																																										
34.100	<i>Timed function 1</i>	Defines which timers are connected to combined timer 1. 0 = Not connected. 1 = Connected. See 34.01 <i>Timed functions status</i> .	0000 0000 0000 0000b																																										
<table border="1"> <thead> <tr> <th>Bit</th> <th>Name</th> <th>Description</th> </tr> </thead> <tbody> <tr> <td>0</td> <td>Timer 1</td> <td>0 = Inactive. 1 = Active.</td> </tr> <tr> <td>1</td> <td>Timer 2</td> <td>0 = Inactive. 1 = Active.</td> </tr> <tr> <td>2</td> <td>Timer 3</td> <td>0 = Inactive. 1 = Active.</td> </tr> <tr> <td>3</td> <td>Timer 4</td> <td>0 = Inactive. 1 = Active.</td> </tr> <tr> <td>4</td> <td>Timer 5</td> <td>0 = Inactive. 1 = Active.</td> </tr> <tr> <td>5</td> <td>Timer 6</td> <td>0 = Inactive. 1 = Active.</td> </tr> <tr> <td>6</td> <td>Timer 7</td> <td>0 = Inactive. 1 = Active.</td> </tr> <tr> <td>7</td> <td>Timer 8</td> <td>0 = Inactive. 1 = Active.</td> </tr> <tr> <td>8</td> <td>Timer 9</td> <td>0 = Inactive. 1 = Active.</td> </tr> <tr> <td>9</td> <td>Timer 10</td> <td>0 = Inactive. 1 = Active.</td> </tr> <tr> <td>10</td> <td>Timer 11</td> <td>0 = Inactive. 1 = Active.</td> </tr> <tr> <td>11</td> <td>Timer 12</td> <td>0 = Inactive. 1 = Active.</td> </tr> <tr> <td>12...15</td> <td>Reserved</td> <td></td> </tr> </tbody> </table>				Bit	Name	Description	0	Timer 1	0 = Inactive. 1 = Active.	1	Timer 2	0 = Inactive. 1 = Active.	2	Timer 3	0 = Inactive. 1 = Active.	3	Timer 4	0 = Inactive. 1 = Active.	4	Timer 5	0 = Inactive. 1 = Active.	5	Timer 6	0 = Inactive. 1 = Active.	6	Timer 7	0 = Inactive. 1 = Active.	7	Timer 8	0 = Inactive. 1 = Active.	8	Timer 9	0 = Inactive. 1 = Active.	9	Timer 10	0 = Inactive. 1 = Active.	10	Timer 11	0 = Inactive. 1 = Active.	11	Timer 12	0 = Inactive. 1 = Active.	12...15	Reserved	
Bit	Name	Description																																											
0	Timer 1	0 = Inactive. 1 = Active.																																											
1	Timer 2	0 = Inactive. 1 = Active.																																											
2	Timer 3	0 = Inactive. 1 = Active.																																											
3	Timer 4	0 = Inactive. 1 = Active.																																											
4	Timer 5	0 = Inactive. 1 = Active.																																											
5	Timer 6	0 = Inactive. 1 = Active.																																											
6	Timer 7	0 = Inactive. 1 = Active.																																											
7	Timer 8	0 = Inactive. 1 = Active.																																											
8	Timer 9	0 = Inactive. 1 = Active.																																											
9	Timer 10	0 = Inactive. 1 = Active.																																											
10	Timer 11	0 = Inactive. 1 = Active.																																											
11	Timer 12	0 = Inactive. 1 = Active.																																											
12...15	Reserved																																												
0000h...FFFFh		Timers connected to combined timer 1.	1 = 1																																										
34.101	<i>Timed function 2</i>	Defines which timers are connected to combined timer 2. See 34.01 <i>Timed functions status</i> .	0000 0000 0000 0000b																																										
34.102	<i>Timed function 3</i>	Defines which timers are connected to combined timer 3. See 34.01 <i>Timed functions status</i> .	0000 0000 0000 0000b																																										
34.110	<i>Boost time function</i>	Defines which combined timers (that is, timers that are connected to the combined timers) are activated with the extra time function.	0000 0000 0000 0000b																																										
<table border="1"> <thead> <tr> <th>Bit</th> <th>Name</th> <th>Description</th> </tr> </thead> <tbody> <tr> <td>0</td> <td>Timed function 1</td> <td>0 = Inactive. 1 = Active.</td> </tr> <tr> <td>1</td> <td>Timed function 2</td> <td>0 = Inactive. 1 = Active.</td> </tr> <tr> <td>2</td> <td>Timed function 3</td> <td>0 = Inactive. 1 = Active.</td> </tr> <tr> <td>3...15</td> <td>Reserved</td> <td></td> </tr> </tbody> </table>				Bit	Name	Description	0	Timed function 1	0 = Inactive. 1 = Active.	1	Timed function 2	0 = Inactive. 1 = Active.	2	Timed function 3	0 = Inactive. 1 = Active.	3...15	Reserved																												
Bit	Name	Description																																											
0	Timed function 1	0 = Inactive. 1 = Active.																																											
1	Timed function 2	0 = Inactive. 1 = Active.																																											
2	Timed function 3	0 = Inactive. 1 = Active.																																											
3...15	Reserved																																												
0000h...FFFFh		Combined timers including the extra timer.	1 = 1																																										

No.	Name/Value	Description	Def/FbEq16
34.111	Boost time activation source	Selects the source of extra time activation signal. 0 = Disabled. 1 = Enabled.	<i>Off</i>
	Off	0.	0
	On	1.	1
	DI1	Digital input DI1 (<i>10.02 DI delayed status</i> , bit 0).	2
	DI2	Digital input DI2 (<i>10.02 DI delayed status</i> , bit 1).	3
	DI3	Digital input DI3 (<i>10.02 DI delayed status</i> , bit 2).	4
	DI4	Digital input DI4 (<i>10.02 DI delayed status</i> , bit 3).	5
	DI5	Digital input DI5 (<i>10.02 DI delayed status</i> , bit 4).	6
	DI6	Digital input DI6 (<i>10.02 DI delayed status</i> , bit 5).	7
	<i>Other [bit]</i>	Source selection (see <i>Terms and abbreviations</i> on page 285).	-
34.112	Boost time duration	Defines the time inside which the extra time is deactivated after extra time activation signal is switched off. Example: If parameter 34.111 Boost time activation source is set to <i>DI1</i> and 34.112 Boost time duration is set to 00 01:30, the extra time is active for 1 hour and 30 minutes after digital input DI is deactivated.	00 00:00
	00 00:00...07 00:00	Extra time duration.	1 = 1 min
35 Motor thermal protection		Motor thermal protection settings such as temperature measurement configuration, load curve definition and motor fan control configuration; motor overload protection. See also section <i>Programmable protection functions</i> (page 178).	
35.01	Motor estimated temperature	Displays the motor temperature as estimated by the internal motor thermal protection model (see parameters <i>35.50...35.55</i>). The unit is selected by parameter <i>96.16 Unit selection</i> . This parameter is read-only.	-
	-60...1000 °C or -76...1832 °F	Estimated motor temperature.	1 = 1 unit

No.	Name/Value	Description	Def/FbEq16
35.02	<i>Measured temperature 1</i>	<p>Displays the temperature received through the source defined by parameter 35.11 Temperature 1 source. The unit is selected by parameter 96.16 Unit selection.</p> <p>Notes:</p> <ul style="list-style-type: none"> • With a PTC sensor, the value shown is not a valid measurement. Either 0 ohm (normal temperature) or the value of parameter 35.12 Temperature 1 fault limit (excessive temperature) is shown. • With a PTC sensor connected to DI6, the unit is ohms. • If the measured temperature source selection (35.11) is PTC analog I/O, the motor thermal protection function converts the analog input signal (35.14) to PTC resistance value (ohms) and shows it in this parameter. This is the case even if the parameter name and unit refer to motor temperature (°C or F). You cannot change the unit to ohm for the time being (96.16). <p>This parameter is read-only.</p>	-
	-60...5000 °C or -76...9032 °F, or 0...5000 ohm or [35.12] ohm or [35.14] ohm	Measured temperature 2.	1 = 1 unit
35.03	<i>Measured temperature 2</i>	<p>Displays the temperature received through the source defined by parameter 35.21 Temperature 2 source. The unit is selected by parameter 96.16 Unit selection.</p> <p>Notes:</p> <ul style="list-style-type: none"> • With a PTC sensor, the value shown is not a valid measurement. Either 0 ohm (normal temperature) or the value of parameter 35.22 Temperature 2 fault limit (excessive temperature) is shown. • With a PTC sensor connected to DI6, the unit is ohms. • If the measured temperature source selection (35.21) is PTC analog I/O, the motor thermal protection function converts the analog input signal (35.24) to PTC resistance value (ohms) and shows it in this parameter. This is the case even if the parameter name and unit refer to motor temperature (°C or F). You cannot change the unit to ohm for the time being (96.16). <p>This parameter is read-only.</p>	-
	-60...5000 °C or -76...9032 °F or 0...5000 ohm or [35.22] ohm or [35.24] ohm	Measured temperature 2.	1 = 1 unit
35.05	<i>Motor overload level</i>	<p>Motor overload level as a percent of the motor overload fault limit. See section Motor overload protection (page 159).</p> <p>This parameter is read-only.</p>	0.0%
	0.0...300.0%	<p>Motor overload level.</p> <p>0.0% No motor overloading</p> <p>88.0% Motor overloaded to warning level</p> <p>100.0% Motor overloaded to fault level.</p>	-

No.	Name/Value	Description	Def/FbEq16
35.11	<i>Temperature 1 source</i>	Selects the source from which measured temperature 1 is read. Usually this source is from a sensor connected to the motor controlled by the drive, but it could be used to measure and monitor a temperature from other parts of the process as long as a suitable sensor is used as per the selection list.	<i>Estimated temperature</i>
	Disabled	None. Temperature monitoring function 1 is disabled.	0
	Estimated temperature	Estimated motor temperature (see parameter <i>35.01 Motor estimated temperature</i>). The temperature is estimated from an internal drive calculation. It is important to set up the ambient temperature of the motor in <i>35.50 Motor ambient temperature</i> .	1
	KTY84 analog I/O	KTY84 sensor connected to the analog input selected by parameter <i>35.14 Temperature 1 AI source</i> and an analog output. The following settings are required: <ul style="list-style-type: none"> Set the hardware jumper or switch related to the analog input to U (voltage). Any change must be validated by a control unit reboot. Set the appropriate analog input unit selection parameter in group <i>12 Standard AI</i> to V (volt). In parameter group <i>13 Standard AO</i>, set the source selection parameter of the analog output to <i>Temp sensor 1 excitation</i>. The analog output feeds a constant current through the sensor. As the resistance of the sensor increases along with its temperature, the voltage over the sensor increases. The voltage is read by the analog input and converted into degrees.	2
	Reserved		3...4
	1 × Pt100 analog I/O	Pt100 sensor connected to a standard analog input selected by parameter <i>35.14 Temperature 1 AI source</i> and an analog output. The following settings are required: <ul style="list-style-type: none"> Set the hardware jumper or switch related to the analog input to U (voltage). Any change must be validated by a control unit reboot. Set the appropriate analog input unit selection parameter in group <i>12 Standard AI</i> to V (volt). In parameter group <i>13 Standard AO</i>, set the source selection parameter of the analog output to <i>Temp sensor 1 excitation</i>. The analog output feeds a constant current through the sensor. As the resistance of the sensor increases along with its temperature, the voltage over the sensor increases. The voltage is read by the analog input and converted into degrees.	5
	2 × Pt100 analog I/O	As selection <i>1 × Pt100 analog I/O</i> , but with two sensors connected in series. Using multiple sensors improves measurement accuracy significantly.	6
	3 × Pt100 analog I/O	As selection <i>1 × Pt100 analog I/O</i> , but with three sensors connected in series. Using multiple sensors improves measurement accuracy significantly.	7

No.	Name/Value	Description	Def/FbEq16
	PTC DI6	PTC sensor is connected to DI6. Note: With a PTC sensor, the value shown is not a valid measurement. Either 0 ohm (normal temperature) or the value of parameter 35.22 Temperature 2 fault limit (excessive temperature) is shown.	8
	Reserved		9...10
	Direct temperature	The temperature is taken from the source selected by parameter 35.14 . The value of the source is assumed to be in the unit of temperature specified by 96.16 .	11
	KTY83 analog I/O	KTY83 sensor connected to the analog input selected by parameter 35.14 Temperature 1 AI source and an analog output. The following settings are required: <ul style="list-style-type: none"> • Set the hardware jumper or switch related to the analog input to U (voltage). Any change must be validated by a control unit reboot. • Set the appropriate analog input unit selection parameter in group 12 Standard AI to V (volt). • In parameter group 13 Standard AO, set the source selection parameter of the analog output to Temp sensor 1 excitation. The analog output feeds a constant current through the sensor. As the resistance of the sensor increases along with its temperature, the voltage over the sensor increases. The voltage is read by the analog input and converted into degrees.	12
	1 × Pt1000 analog I/O	Pt1000 sensor connected to a standard analog input selected by parameter 35.14 Temperature 1 AI source and an analog output. The following settings are required: <ul style="list-style-type: none"> • Set the hardware jumper or switch related to the analog input to U (voltage). Any change must be validated by a control unit reboot. • Set the appropriate analog input unit selection parameter in group 12 Standard AI to V (volt). • In parameter group 13 Standard AO, set the source selection parameter of the analog output to Temp sensor 1 excitation. The analog output feeds a constant current through the sensor. As the resistance of the sensor increases along with its temperature, the voltage over the sensor increases. The voltage is read by the analog input and converted into degrees.	13
	2 × Pt1000 analog I/O	As selection 1 × Pt1000 analog I/O , but with two sensors connected in series. Using multiple sensors improves measurement accuracy significantly.	14
	3 × Pt1000 analog I/O	As selection 1 × Pt1000 analog I/O , but with three sensors connected in series. Using multiple sensors improves measurement accuracy significantly.	15

No.	Name/Value	Description	Def/FbEq16
	Ni1000	<p>Ni1000 sensor connected to the analog input selected by parameter 35.14 Temperature 1 AI source and an analog output.</p> <p>The following settings are required:</p> <ul style="list-style-type: none"> Set the hardware jumper or switch related to the analog input to U (voltage). Any change must be validated by a control unit reboot. Set the appropriate analog input unit selection parameter in group 12 Standard AI to V (volt). In parameter group 13 Standard AO, set the source selection parameter of the analog output to Temp sensor 1 excitation. <p>The analog output feeds a constant current through the sensor. As the resistance of the sensor increases along with its temperature, the voltage over the sensor increases. The voltage is read by the analog input and converted into degrees.</p>	16
	Reserved		17...18
	PTC extension module	PTC is connected to the CMOD-02 multifunction extension module, which is installed in drive slot 2. See chapter <i>Optional I/O extension modules, section CMOD-02 multifunction extension module (external 24 V AC/DC and isolated PTC interface)</i> in the <i>Hardware manual</i> of the drive).	19
	PTC analog I/O	<p>PTC sensor connected to the analog input selected by parameter 35.14 and an analog output.</p> <p>The required settings are the same as with selection KTY84 analog I/O. If a PTC sensor is used, the voltage ready by the analog input is converted into ohms.</p> <p>Note: With this selection, the control program converts the analog signal to PTC resistance value in ohms and shows it in parameter 35.02. The parameter name and unit still refer to temperature.</p>	20
	Therm(0)	PTC sensor or a normally closed thermistor relay connected to digital input DI6. The motor is overheated when the digital input is 0.	21
	Therm(1)	Normally open thermistor relay connected to digital input DI6. The motor is overheated when the digital input is 1.	22
	Reserved		23
	35.12 Temperature 1 fault limit	<p>Defines the fault limit for temperature supervision function 1. When measured temperature 1 exceeds the limit, the drive trips on fault 4981 External temperature 1.</p> <p>The unit is selected by parameter 96.16 Unit selection.</p> <p>Notes:</p> <ul style="list-style-type: none"> With a PTC sensor, the unit is ohms. With a PTC sensor, changing the value of this parameter has no effect on fault generation. When PTC is over the triggering threshold of the CMOD-02 (see the <i>Hardware manual</i>), the drive trips on the fault and when PTC has decreased below recovery threshold of the CMOD-02 (see the <i>Hardware manual</i>), the fault can be reset manually. 	130 °C or 266 °F or 4500 ohm
	-60...5000 °C or -76...9032 °F or 0...5000 ohm	Fault limit for temperature monitoring function 1.	1 = 1 unit

No.	Name/Value	Description	Def/FbEq16
35.13	<i>Temperature 1 warning limit</i>	Defines the warning limit for temperature supervision function 1. When measured temperature 1 exceeds the limit, warning <i>A491 External temperature 1</i> is generated. The unit is selected by parameter <i>96.16 Unit selection</i> . Notes: <ul style="list-style-type: none"> • With a PTC sensor, the unit is ohms. • With a PTC sensor, changing the value of this parameter has no effect on warning generation. When PTC is over the triggering threshold of the CMOD-02 (see the <i>Hardware manual</i>), the drive trips on the fault and when PTC has decreased below recovery threshold of the CMOD-02 (see the <i>Hardware manual</i>), the fault can be reset manually. 	110 °C or 230 °F or 4000 ohm
	-60...5000 °C or -76...9032 °F or 0...5000 ohm	Warning limit for temperature monitoring function 1.	1 = 1 unit
35.14	<i>Temperature 1 AI source</i>	Specifies the analog input when the setting of <i>35.11 Temperature 1 source</i> requires measurement through an analog input. Note: If parameter <i>35.11 Temperature 1 source</i> is set to <i>Direct temperature</i> , use selection <i>Other</i> here, and point to <i>12.12 AI1 scaled value</i> .	<i>Not selected</i>
	Not selected	None.	0
	AI1 actual value	Analog input AI1 on the control unit.	1
	AI2 actual value	Analog input AI2 on the control unit.	2
	<i>Other</i>	Source selection (see <i>Terms and abbreviations</i> on page 285).	-
35.21	<i>Temperature 2 source</i>	Selects the source from which measured temperature 2 is read. Usually this source is from a sensor connected to the motor controlled by the drive, but it could be used to measure and monitor a temperature from other parts of the process as long as a suitable sensor is used as per the selection list.	<i>Estimated temperature</i>
	Disabled	None. Temperature monitoring function 2 is disabled.	0
	Estimated temperature	Estimated motor temperature (see parameter <i>35.01 Motor estimated temperature</i>). The temperature is estimated from an internal drive calculation. It is important to set up the ambient temperature of the motor in <i>35.50 Motor ambient temperature</i> .	1

No.	Name/Value	Description	Def/FbEq16
	KTY84 analog I/O	<p>KTY84 sensor connected to the analog input selected by parameter 35.24 Temperature 2 AI source and an analog output.</p> <p>The following settings are required:</p> <ul style="list-style-type: none"> Set the hardware jumper or switch related to the analog input to U (voltage). Any change must be validated by a control unit reboot. Set the appropriate analog input unit selection parameter in group 12 Standard AI to V (volt). In parameter group 13 Standard AO, set the source selection parameter of the analog output to Temp sensor 2 excitation. <p>The analog output feeds a constant current through the sensor. As the resistance of the sensor increases along with its temperature, the voltage over the sensor increases. The voltage is read by the analog input and converted into degrees.</p>	2
	Reserved		3...4
	1 × Pt100 analog I/O	<p>Pt100 sensor connected to a standard analog input selected by parameter 35.24 Temperature 2 AI source and an analog output.</p> <p>The following settings are required:</p> <ul style="list-style-type: none"> Set the hardware jumper or switch related to the analog input to U (voltage). Any change must be validated by a control unit reboot. Set the appropriate analog input unit selection parameter in group 12 Standard AI to V (volt). In parameter group 13 Standard AO, set the source selection parameter of the analog output to Temp sensor 2 excitation. <p>The analog output feeds a constant current through the sensor. As the resistance of the sensor increases along with its temperature, the voltage over the sensor increases. The voltage is read by the analog input and converted into degrees.</p>	5
	2 × Pt100 analog I/O	As selection 1 × Pt100 analog I/O , but with two sensors connected in series. Using multiple sensors improves measurement accuracy significantly.	6
	3 × Pt100 analog I/O	As selection 1 × Pt100 analog I/O , but with three sensors connected in series. Using multiple sensors improves measurement accuracy significantly.	7
	PTC DI6	<p>PTC sensor is connected to DI6.</p> <p>Note: With a PTC sensor, the value shown is not a valid measurement. Either 0 ohm (normal temperature) or the value of parameter 35.22 Temperature 2 fault limit (excessive temperature) is shown.</p>	8
	Reserved		9...10
	Direct temperature	The temperature is taken from the source selected by parameter 35.24 . The value of the source is assumed to be in the unit of temperature specified by 96.16 .	11

No.	Name/Value	Description	Def/FbEq16
	KTY83 analog I/O	<p>KTY83 sensor connected to the analog input selected by parameter 35.14 Temperature 1 AI source and an analog output.</p> <p>The following settings are required:</p> <ul style="list-style-type: none"> • Set the hardware jumper or switch related to the analog input to U (voltage). Any change must be validated by a control unit reboot. • Set the appropriate analog input unit selection parameter in group 12 Standard AI to V (volt). • In parameter group 13 Standard AO, set the source selection parameter of the analog output to Temp sensor 2 excitation. <p>The analog output feeds a constant current through the sensor. As the resistance of the sensor increases along with its temperature, the voltage over the sensor increases. The voltage is read by the analog input and converted into degrees.</p>	12
	1 × Pt1000 analog I/O	<p>Pt1000 sensor connected to a standard analog input selected by parameter 35.14 Temperature 1 AI source and an analog output.</p> <p>The following settings are required:</p> <ul style="list-style-type: none"> • Set the hardware jumper or switch related to the analog input to U (voltage). Any change must be validated by a control unit reboot. • Set the appropriate analog input unit selection parameter in group 12 Standard AI to V (volt). • In parameter group 13 Standard AO, set the source selection parameter of the analog output to Temp sensor 2 excitation. <p>The analog output feeds a constant current through the sensor. As the resistance of the sensor increases along with its temperature, the voltage over the sensor increases. The voltage is read by the analog input and converted into degrees.</p>	13
	2 × Pt1000 analog I/O	<p>As selection 1 × Pt1000 analog I/O, but with two sensors connected in series. Using multiple sensors improves measurement accuracy significantly.</p>	14
	3 × Pt1000 analog I/O	<p>As selection 1 × Pt1000 analog I/O, but with three sensors connected in series. Using multiple sensors improves measurement accuracy significantly.</p>	15
	Ni1000	<p>Ni1000 sensor connected to the analog input selected by parameter 35.14 Temperature 1 AI source and an analog output.</p> <p>The following settings are required:</p> <ul style="list-style-type: none"> • Set the hardware jumper or switch related to the analog input to U (voltage). Any change must be validated by a control unit reboot. • Set the appropriate analog input unit selection parameter in group 12 Standard AI to V (volt). • In parameter group 13 Standard AO, set the source selection parameter of the analog output to Temp sensor 2 excitation. <p>The analog output feeds a constant current through the sensor. As the resistance of the sensor increases along with its temperature, the voltage over the sensor increases. The voltage is read by the analog input and converted into degrees.</p>	16

No.	Name/Value	Description	Def/FbEq16
	Reserved		17...18
	PTC extension module	PTC is connected to the CMOD-02 multifunction extension module, which is installed in drive slot 2. See chapter <i>Optional I/O extension modules, section CMOD-02 multifunction extension module (external 24 V AC/DC and isolated PTC interface)</i> in the <i>Hardware manual</i> of the drive).	19
	PTC analog I/O	PTC sensor connected to the analog input selected by parameter 35.24 and an analog output. The required settings are the same as with selection KTY84 analog I/O . If a PTC sensor is used, the voltage ready by the analog input is converted into ohms. Note: With this selection, the control program converts the analog signal to PTC resistance value in ohms and shows it in parameter 35.03 . The parameter name and unit still refer to temperature.	20
	Therm(0)	PTC sensor or a normally closed thermistor relay connected to digital input DI6. The motor is overheated when the digital input is 0.	21
	Therm(1)	Normally open thermistor relay connected to digital input DI6. The motor is overheated when the digital input is 1.	22
35.22	Temperature 2 fault limit	Defines the fault limit for temperature supervision function 2. When measured temperature 1 exceeds the limit, the drive trips on fault 4982 External temperature 2 . The unit is selected by parameter 96.16 Unit selection . Notes: <ul style="list-style-type: none"> With a PTC sensor, the unit is ohms. With a PTC sensor, changing the value of this parameter has no effect on warning generation. When PTC is over the triggering threshold of the CMOD-02 (see the <i>Hardware manual</i>), the drive trips on the fault and when PTC has decreased below recovery threshold of the CMOD-02 (see the <i>Hardware manual</i>), the fault can be reset manually. 	130 °C or 266 °F or 4500 ohm
	-60...5000 °C or -76...9032 °F or 0...5000 ohm	Fault limit for temperature monitoring function 2.	1 = 1 unit
35.23	Temperature 2 warning limit	Defines the warning limit for temperature supervision function 2. When measured temperature 1 exceeds the limit, warning A492 External temperature 2 is generated. The unit is selected by parameter 96.16 Unit selection . Notes: <ul style="list-style-type: none"> With a PTC sensor, the unit is ohms. With a PTC sensor, changing the value of this parameter has no effect on fault generation. When PTC is over the triggering threshold of the CMOD-02 (see the <i>Hardware manual</i>), the drive trips on the fault and when PTC has decreased below recovery threshold of the CMOD-02 (see the <i>Hardware manual</i>), the fault can be reset manually. 	110 °C or 230 °F or 4000 ohm
	-60...5000 °C or -76...9032 °F or 0...500 0 ohm	Warning limit for temperature monitoring function 2.	1 = 1 unit

No.	Name/Value	Description	Def/FbEq16
35.24	<i>Temperature 2 AI source</i>	Specifies the analog input when the setting of 35.11 Temperature 1 source requires measurement through an analog input.	<i>Not selected</i>
	Not selected	None.	0
	AI1 actual value	Analog input AI1 on the control unit.	1
	AI2 actual value	Analog input AI2 on the control unit.	2
	<i>Other</i>	Source selection (see Terms and abbreviations on page 285).	-
35.31	<i>Safe motor temperature enable</i>	Activates or deactivates the Safe motor temperature (SMT) fault indication 4991 Safe motor temperature . Automatically activated when the CPTC-02 ATEX-certified thermistor protection module is connected to the drive.	<i>Off</i>
	Off	Activated.	0
	On	Deactivated.	1
35.50	<i>Motor ambient temperature</i>	Defines the ambient temperature of the motor for the motor thermal protection model. The unit is selected by parameter 96.16 Unit selection . The motor thermal protection model estimates the motor temperature on the basis of parameters 35.50...35.55 . The motor temperature increases if it operates in the region above the load curve, and decreases if it operates in the region below the load curve.  WARNING! The model cannot protect the motor if the motor does not cool properly because of dust, dirt, etc.	20 °C or 68 °F
	-60...100 °C or -76 ... 212 °F	Ambient temperature.	1 = 1 unit

No.	Name/Value	Description	Def/FbEq16
35.51	<i>Motor load curve</i>	<p>Defines the maximum thermal load of the motor. If the load is above the curve, the motor can be overheated. The load curve is used by the motor thermal protection model to estimate the motor temperature.</p> <p>When the parameter is set to 100%, the maximum load is taken as the value of parameter 99.06 Motor nominal current (higher loads heat up the motor). The load curve level should be adjusted if the ambient temperature differs from the nominal value set in 35.50 Motor ambient temperature.</p>	110%
<p style="text-align: center;">$I =$ Motor current $I_N =$ Nominal motor current</p>			
	50...150%	Maximum load for the motor load curve.	1 = 1%
35.52	<i>Zero speed load</i>	<p>Defines the motor load curve together with parameters 35.51 Motor load curve and 35.53 Break point. Defines the maximum motor load at zero speed of the load curve. A higher value can be used if the motor has an external motor fan to boost the cooling. See the motor manufacturer's recommendations.</p> <p>See parameter 35.51 Motor load curve.</p>	70%
	25...150%	Zero speed load for the motor load curve.	1 = 1%
35.53	<i>Break point</i>	<p>Defines the motor load curve together with parameters 35.51 Motor load curve and 35.52 Zero speed load. Defines the break point frequency of the load curve, ie, the point at which the motor load curve begins to decrease from the value of parameter 35.51 Motor load curve towards the value of parameter 35.52 Zero speed load.</p> <p>See parameter 35.51 Motor load curve.</p>	45.00 Hz
	1.00...500.00 Hz	Break point for the motor load curve.	See par. 46.02

No.	Name/Value	Description	Def/FbEq16
35.54	<i>Motor nominal temperature rise</i>	<p>Defines the temperature rise of the motor above ambient when the motor is loaded with nominal current. See the motor manufacturer's recommendations.</p> <p>The unit is selected by parameter 96.16 Unit selection.</p>	80 °C or 176 °F
	0...300 °C or 32...572 °F	Temperature rise.	1 = 1 unit
35.55	<i>Motor thermal time constant</i>	<p>Defines the thermal time constant for use with the motor thermal protection model, defined as the time to reach 63% of the nominal motor temperature. See the motor manufacturer's recommendations.</p> <p>For thermal protection according to UL requirements for NEMA class motors, use the rule of thumb: Motor thermal time equals 35 times t_6, where t_6 (in seconds) is specified by the motor manufacturer as the time that the motor can safely operate at six times its rated current.</p>	256 s
	100...10000 s	Motor thermal time constant.	1 = 1 s

No.	Name/Value	Description	Def/FbEq16
35.56	<i>Motor overload action</i>	Selects the action taken when the system detects the motor overload specified by parameter 35.57. See section <i>Motor overload protection</i> (page 159).	<i>Warning and fault</i>
	No action	No action taken.	0
	Warning only	Drive generates warning <i>A783 Motor overload</i> when the motor is overloaded to the warning level, that is, parameter <i>35.05 Motor overload level</i> reaches value 88.0%.	1
	Warning and fault	Drive generates warning <i>A783 Motor overload</i> when the motor is overloaded to the warning level, that is, parameter <i>35.05 Motor overload level</i> reaches value 88.0%. Drive trips on fault <i>7122 Motor overload</i> when the motor is overloaded to the fault level, that is, parameter <i>35.05 Motor overload level</i> reaches value 100.0%.	2
35.57	<i>Motor overload class</i>	Defines the motor overload class to be used. The class of protection is specified by the user as the time for tripping at 7.2 times (IEC 60947-4-1) or 6 times (NEMA ICS) the tripping level current. See section <i>Motor overload protection</i> (page 159).	<i>Class 20</i>
	Class 5	Motor overload class 5.	0
	Class 10	Motor overload class 10.	1
	Class 20	Motor overload class 20.	2
	Class 30	Motor overload class 30.	3
	Class 40	Motor overload class 40.	4
36 Load analyzer		Peak value and amplitude logger settings. See also section <i>Load analyzer</i> (page 176).	
36.01	<i>PVL signal source</i>	Selects the signal to be monitored by the peak value logger. The signal is filtered using the filtering time specified by parameter <i>36.02 PVL filter time</i> . The peak value is stored, along with other pre-selected signals at the time, into parameters <i>36.10...36.15</i> . The peak value logger can be reset using parameter <i>36.09 Reset loggers</i> . The logger is also reset whenever the signal source is changed. The date and time of the last reset are stored into parameters <i>36.16</i> and <i>36.17</i> respectively.	<i>Motor current</i>
	Not selected	None (peak value logger disabled).	0
	Motor speed used	<i>01.01 Motor speed used</i> (page 288).	1
	Reserved		2
	Output frequency	<i>01.06 Output frequency</i> (page 288).	3
	Motor current	<i>01.07 Motor current</i> (page 288).	4
	Reserved		5
	Motor torque	<i>01.10 Motor torque</i> (page 288).	6
	DC voltage	<i>01.11 DC voltage</i> (page 288).	7
	Output power	<i>01.14 Output power</i> (page 289).	8
	Reserved		9
	Speed ref ramp in	<i>23.01 Speed ref ramp input</i> (page 370).	10
	Speed ref ramp out	<i>23.02 Speed ref ramp output</i> (page 370).	11
	Speed ref used	<i>24.01 Used speed reference</i> (page 371).	12

No.	Name/Value	Description	Def/FbEq16
	Reserved		13
	Freq ref used	28.02 Frequency ref ramp output (page 377).	14
	Reserved		15
	Process PID out	40.01 Process PID output actual (page 437).	16
	<i>Other</i>	Source selection (see Terms and abbreviations on page 285).	-
36.02	PVL filter time	Peak value logger filtering time. See parameter 36.01 PVL signal source .	2.00 s
	0.00...120.00 s	Peak value logger filtering time.	100 = 1 s
36.06	AL2 signal source	Selects the signal to be monitored by amplitude logger 2. The signal is sampled at 200 ms intervals. The results are displayed by parameters 36.40...36.49 . Each parameter represents an amplitude range, and shows what portion of the samples fall within that range. The signal value corresponding to 100% is defined by parameter 36.07 AL2 signal scaling . Amplitude logger 2 can be reset using parameter 36.09 Reset loggers . The logger is also reset whenever the signal source or scaling is changed. The date and time of the last reset are stored into parameters 36.50 and 36.51 respectively. For the selections, see parameter 36.01 PVL signal source .	Output power
36.07	AL2 signal scaling	Defines the signal value that corresponds to 100% amplitude.	100.00
	0.00...32767.00	Signal value corresponding to 100%.	1 = 1
36.09	Reset loggers	Resets the peak value logger and/or amplitude logger 2. (Amplitude logger 1 cannot be reset.)	Done
	Done	Reset completed or not requested (normal operation).	0
	All	Reset both the peak value logger and amplitude logger 2.	1
	PVL	Reset the peak value logger.	2
	AL2	Reset amplitude logger 2.	3
36.10	PVL peak value	Peak value recorded by the peak value logger.	0.00
	-32768.00... 32767.00	Peak value.	1 = 1
36.11	PVL peak date	The date on which the peak value was recorded.	01.01.1980
	-	Peak occurrence date.	-
36.12	PVL peak time	The time at which the peak value was recorded.	00:00:05
	-	Peak occurrence time.	-
36.13	PVL current at peak	Motor current at the moment the peak value was recorded.	0.00 A
	-32768.00... 32767.00 A	Motor current at peak.	1 = 1 A
36.14	PVL DC voltage at peak	Voltage in the intermediate DC circuit of the drive at the moment the peak value was recorded.	0.00 V
	0.00...2000.00 V	DC voltage at peak.	10 = 1 V
36.15	PVL speed at peak	Motor speed at the moment the peak value was recorded.	0.00 rpm
	-30000.00... 30000.00 rpm	Motor speed at peak.	See par. 46.01

No.	Name/Value	Description	Def/FbEq16
36.16	<i>PVL reset date</i>	The date on which the peak value logger was last reset.	01.01.1980
-	-	Last reset date of the peak value logger.	
36.17	<i>PVL reset time</i>	The time at which the peak value logger was last reset.	00:00:05
-	-	Last reset time of the peak value logger.	
36.20	<i>AL1 0 to 10%</i>	Percentage of samples recorded by amplitude logger 1 that fall between 0 and 10%. 100% corresponds to the I_{max} value given in the ratings table in chapter Technical data in the <i>Hardware manual</i> of the drive.	0.00%
0.00...100.00%		Amplitude logger 1 samples between 0 and 10%.	1 = 1%
36.21	<i>AL1 10 to 20%</i>	Percentage of samples recorded by amplitude logger 1 that fall between 10 and 20%.	0.00%
0.00...100.00%		Amplitude logger 1 samples between 10 and 20%.	1 = 1%
36.22	<i>AL1 20 to 30%</i>	Percentage of samples recorded by amplitude logger 1 that fall between 20 and 30%.	0.00%
0.00...100.00%		Amplitude logger 1 samples between 20 and 30%.	1 = 1%
36.23	<i>AL1 30 to 40%</i>	Percentage of samples recorded by amplitude logger 1 that fall between 30 and 40%.	0.00%
0.00...100.00%		Amplitude logger 1 samples between 30 and 40%.	1 = 1%
36.24	<i>AL1 40 to 50%</i>	Percentage of samples recorded by amplitude logger 1 that fall between 40 and 50%.	0.00%
0.00...100.00%		Amplitude logger 1 samples between 40 and 50%.	1 = 1%
36.25	<i>AL1 50 to 60%</i>	Percentage of samples recorded by amplitude logger 1 that fall between 50 and 60%.	0.00%
0.00...100.00%		Amplitude logger 1 samples between 50 and 60%.	1 = 1%
36.26	<i>AL1 60 to 70%</i>	Percentage of samples recorded by amplitude logger 1 that fall between 60 and 70%.	0.00%
0.00...100.00%		Amplitude logger 1 samples between 60 and 70%.	1 = 1%
36.27	<i>AL1 70 to 80%</i>	Percentage of samples recorded by amplitude logger 1 that fall between 70 and 80%.	0.00%
0.00...100.00%		Amplitude logger 1 samples between 70 and 80%.	1 = 1%
36.28	<i>AL1 80 to 90%</i>	Percentage of samples recorded by amplitude logger 1 that fall between 80 and 90%.	0.00%
0.00...100.00%		Amplitude logger 1 samples between 80 and 90%.	1 = 1%
36.29	<i>AL1 over 90%</i>	Percentage of samples recorded by amplitude logger 1 that exceed 90%.	0.00%
0.00...100.00%		Amplitude logger 1 samples over 90%.	1 = 1%
36.40	<i>AL2 0 to 10%</i>	Percentage of samples recorded by amplitude logger 2 that fall between 0 and 10%.	0.00%
0.00...100.00%		Amplitude logger 2 samples between 0 and 10%.	1 = 1%
36.41	<i>AL2 10 to 20%</i>	Percentage of samples recorded by amplitude logger 2 that fall between 10 and 20%.	0.00%
0.00...100.00%		Amplitude logger 2 samples between 10 and 20%.	1 = 1%
36.42	<i>AL2 20 to 30%</i>	Percentage of samples recorded by amplitude logger 2 that fall between 20 and 30%.	0.00%
0.00...100.00%		Amplitude logger 2 samples between 20 and 30%.	1 = 1%

No.	Name/Value	Description	Def/FbEq16
36.43	AL2 30 to 40%	Percentage of samples recorded by amplitude logger 2 that fall between 30 and 40%.	0.00%
	0.00...100.00%	Amplitude logger 2 samples between 30 and 40%.	1 = 1%
36.44	AL2 40 to 50%	Percentage of samples recorded by amplitude logger 2 that fall between 40 and 50%.	0.00%
	0.00...100.00%	Amplitude logger 2 samples between 40 and 50%.	1 = 1%
36.45	AL2 50 to 60%	Percentage of samples recorded by amplitude logger 2 that fall between 50 and 60%.	0.00%
	0.00...100.00%	Amplitude logger 2 samples between 50 and 60%.	1 = 1%
36.46	AL2 60 to 70%	Percentage of samples recorded by amplitude logger 2 that fall between 60 and 70%.	0.00%
	0.00...100.00%	Amplitude logger 2 samples between 60 and 70%.	1 = 1%
36.47	AL2 70 to 80%	Percentage of samples recorded by amplitude logger 2 that fall between 70 and 80%.	0.00%
	0.00...100.00%	Amplitude logger 2 samples between 70 and 80%.	1 = 1%
36.48	AL2 80 to 90%	Percentage of samples recorded by amplitude logger 2 that fall between 80 and 90%.	0.00%
	0.00...100.00%	Amplitude logger 2 samples between 80 and 90%.	1 = 1%
36.49	AL2 over 90%	Percentage of samples recorded by amplitude logger 2 that exceed 90%.	0.00%
	0.00...100.00%	Amplitude logger 2 samples over 90%.	1 = 1%
36.50	AL2 reset date	The date on which amplitude logger 2 was last reset.	01.01.1980
	-	Last reset date of amplitude logger 2.	
36.51	AL2 reset time	The time at which amplitude logger 2 was last reset.	00:00:05
	-	Last reset time of amplitude logger 2.	

37 User load curve

Settings for user load curve.
See also section [User load curve \(Condition monitoring\)](#) (page 181).

37.01 ULC output status word

Displays the status of the monitored signal. The status is shown only while the drive is running. (The status word is independent of the actions and delays selected by parameters [37.03](#), [37.04](#), [37.41](#) and [37.42](#).)
This parameter is read-only.

Bit	Name	Description
0	Under load limit	1 = Signal lower than the underload curve.
1	Within load range	1 = Signal between the underload and overload curve.
2	Overload limit	1 = Signal higher than the overload curve.
3	Outside load limit	1 = Signal lower than the underload curve or higher than the overload curve.
4...15	Reserved	

0000h...FFFFh Status of the monitored signal. 1 = 1

37.02 ULC supervision signal

Selects the signal to be monitored. The function compares the absolute value of the signal against the load curve.

Not selected No signal selected (monitoring disabled). 0

No.	Name/Value	Description	Def/FbEq16
	Motor speed %	01.03 Motor speed % (page 288).	1
	Motor current %	01.08 Motor current % of motor nom (page 288).	2
	Motor torque %	01.10 Motor torque (page 288).	3
	Output power % of motor nominal	01.15 Output power % of motor nom (page 289).	4
	Output power % of drive nominal	Output power % of drive nominal.	5
	<i>Other</i>	Source selection (see Terms and abbreviations on page 285).	-
37.03	<i>ULC overload actions</i>	Selects how the drive reacts if the absolute value of the monitored signal stays continuously above the overload curve for longer than the value of 37.41 ULC overload timer .	<i>Disabled</i>
	Disabled	No action taken.	0
	Warning	Drive generates warning A8BE ULC overload warning .	1
	Fault	Drive trips on fault 8002 ULC overload fault .	2
	Warning/Fault	Drive generates warning A8BE ULC overload warning if the signal stays continuously above the overload curve for half of the time defined by parameter 37.41 ULC overload timer . Drive trips on fault 8002 ULC overload fault if the signal stays continuously above the overload curve for a time defined by parameter 37.41 ULC overload timer .	3
37.04	<i>ULC underload actions</i>	Selects how the drive reacts if the absolute value of the monitored signal stays continuously above the overload curve for longer than the value of 37.42 ULC underload timer .	<i>Disabled</i>
	Disabled	No action taken.	0
	Warning	Drive generates warning A8BF ULC underload warning .	1
	Fault	Drive trips on fault 8001 ULC underload fault .	2
	Warning/Fault	Drive generates warning A8BF ULC underload warning if the signal stays continuously below the underload curve for half of the time defined by parameter 37.41 ULC overload timer . Drive trips on fault 8001 ULC underload fault if the signal stays continuously above the underload curve for a time defined by parameter 37.42 ULC underload timer .	3
37.11	<i>ULC speed table point 1</i>	Defines the first of the five speed points on the X-axis of the user load curve. Speed points are used if parameter 99.04 Motor control mode is set to <i>Vector</i> or if 99.04 Motor control mode is set to <i>Scalar</i> and the reference unit is rpm. The five points must be in order from lowest to highest. The points are defined as positive values, but the range is symmetrically effective also in the negative direction. The monitoring is not active outside these two areas.	150.0 rpm
	-30000.0...30000.0 rpm	Speed.	1 = 1 rpm
37.12	<i>ULC speed table point 2</i>	Defines the second speed point. See parameter 37.11 ULC speed table point 1 .	750.0 rpm
	-30000.0...30000.0 rpm	Speed.	1 = 1 rpm

No.	Name/Value	Description	Def/FbEq16
37.13	ULC speed table point 3	Defines the third speed point. See parameter 37.11 ULC speed table point 1 .	1290.0 rpm
	-30000.0...30000.0 rpm	Speed.	1 = 1 rpm
37.14	ULC speed table point 4	Defines the fourth speed point. See parameter 37.11 ULC speed table point 1 .	1500.0 rpm
	-30000.0...30000.0 rpm	Speed.	1 = 1 rpm
37.15	ULC speed table point 5	Defines the fifth speed point. See parameter 37.11 ULC speed table point 1 .	1800.0 rpm
	-30000.0...30000.0 rpm	Speed.	1 = 1 rpm
37.16	ULC frequency table point 1	Defines the first of the five frequency points on the X-axis of the user load curve. Frequency points are used if parameter 99.04 Motor control mode is set to <i>Scalar</i> and the reference unit is Hz. The five points must be in order from lowest to highest. The points are defined as positive values, but the range is symmetrically effective also in the negative direction. The monitoring is not active outside these two areas.	5.0 Hz
	-500.0...500.0 Hz	Frequency.	1 = 1 Hz
37.17	ULC frequency table point 2	Defines the second frequency point. See parameter 37.16 ULC frequency table point 1 .	25.0 Hz
	-500.0...500.0 Hz	Frequency.	1 = 1 Hz
37.18	ULC frequency table point 3	Defines the third frequency point. See parameter 37.16 ULC frequency table point 1 .	43.0 Hz
	-500.0...500.0 Hz	Frequency.	1 = 1 Hz
37.19	ULC frequency table point 4	Defines the fourth frequency point. See parameter 37.16 ULC frequency table point 1 .	50.0 Hz
	-500.0...500.0 Hz	Frequency.	1 = 1 Hz
37.20	ULC frequency table point 5	Defines the fifth frequency point. See parameter 37.16 ULC frequency table point 1 .	60.0 Hz
	-500.0...500.0 Hz	Frequency.	1 = 1 Hz
37.21	ULC underload point 1	Defines the first of the five points on the Y-axis that together with the corresponding point on the X-axis (37.11 ULC speed table point 1 ... 37.15 ULC speed table point 5 or 37.15 ULC speed table point 5 ... 37.20 ULC frequency table point 5) define the underload (lower) curve. Each point of the underload curve must have a lower value than the corresponding overload point.	10.0%
	-1600.0...1600.0%	Underload point.	1 = 1%
37.22	ULC underload point 2	Defines the second underload point. See parameter 37.21 ULC underload point 1 .	15.0%
	-1600.0...1600.0%	Underload point.	1 = 1%
37.23	ULC underload point 3	Defines the third underload point. See parameter 37.21 ULC underload point 1 .	25.0%
	-1600.0...1600.0%	Underload point.	1 = 1%

No.	Name/Value	Description	Def/FbEq16
37.24	<i>ULC underload point 4</i>	Defines the fourth underload point. See parameter 37.21 ULC underload point 1 .	30.0%
	-1600.0...1600.0%	Underload point.	1 = 1%
37.25	<i>ULC underload point 5</i>	Defines the fifth underload point. See parameter 37.21 ULC underload point 1	30.0%
	-1600.0...1600.0%	Underload point.	1 = 1%
37.31	<i>ULC overload point 1</i>	Defines the first of the five points on the Y-axis that together with the corresponding point on the X-axis (37.11 ULC speed table point 1...37.15 ULC speed table point 5 or 37.15 ULC speed table point 5...37.20 ULC frequency table point 5) define the overload (higher) curve. Each point of the overload curve must have a higher value than the corresponding underload point.	300.0%
	-1600.0...1600.0%	Overload point.	1 = 1%
37.32	<i>ULC overload point 2</i>	Defines the second overload point. See parameter 37.31 ULC overload point 1 .	300.0%
	-1600.0...1600.0%	Overload point.	1 = 1%
37.33	<i>ULC overload point 3</i>	Defines the third overload point. See parameter 37.31 ULC overload point 1 .	300.0%
	-1600.0...1600.0%	Overload point.	1 = 1%
37.34	<i>ULC overload point 4</i>	Defines the fourth overload point. See parameter 37.31 ULC overload point 1 .	300.0%
	-1600.0...1600.0%	Overload point.	1 = 1%
37.35	<i>ULC overload point 5</i>	Defines the fifth overload point. See parameter 37.31 ULC overload point 1 .	300.0%
	-1600.0...1600.0%	Overload point.	1 = 1%
37.41	<i>ULC overload timer</i>	Defines the time for which the monitored signal must continuously stay above the overload curve before the drive takes the action selected by 37.03 ULC overload actions .	20.0 s
	0.0...10000.0 s	Overload timer.	1 = 1 s
37.42	<i>ULC underload timer</i>	Defines the time for which the monitored signal must continuously stay below the underload curve before the drive takes the action selected by 37.04 ULC underload actions .	20.0 s
	0.0...10000.0 s	Underload timer	1 = 1 s

No.	Name/Value	Description	Def/FbEq16
40	Process PID set 1	<p>Parameter values for process PID control.</p> <p>The drive output can be controlled by the process PID. When the process PID control is enabled, the drive controls the process feedback to the reference value.</p> <p>Two different parameter sets can be defined for the process PID. One parameter set is in use at a time. The first set is made up of parameters 40.07...40.50, the second set is defined by the parameters in group 41 Process PID set 2. The binary source that defines which set is used is selected by parameter 40.57 PID set1/set2 selection.</p> <p>See also control chain diagram PID setpoint compensation on page 277.</p> <p>To set the PID customer unit, select Menu > Primary settings > PID > Unit on the control panel.</p>	
40.01	<i>Process PID output actual</i>	Displays the output of the process PID controller. See control chain diagram Process PID controller on page 279 . This parameter is read-only.	-
	-200000.00... 200000.00	Process PID controller output.	1 = 1
40.02	<i>Process PID feedback actual</i>	Displays the value of process feedback after source selection, mathematical function (parameter 40.10 Set 1 feedback function), and filtering. See control chain diagram PID setpoint compensation on page 277 . This parameter is read-only.	-
	-200000.00... 200000.00 bar	Process feedback.	1 = 1 bar
40.03	<i>Process PID setpoint actual</i>	Displays the value of process PID setpoint after source selection, mathematical function (40.18 Set 1 setpoint function), limitation and ramping. See control chain diagram PID setpoint compensation on page 277 . This parameter is read-only.	-
	-200000...200000 bar	Setpoint for process PID controller.	1 = 1 bar
40.04	<i>Process PID deviation actual</i>	Displays the process PID deviation. By default, this value equals setpoint - feedback, but deviation can be inverted by parameter 40.31 Set 1 deviation inversion . See control chain diagram Process PID controller on page 279 . This parameter is read-only.	-
	-200000.00... 200000.00 bar	PID deviation.	1 = 1 bar

No.	Name/Value	Description	Def/FbEq16																																													
40.06	<i>Process PID status word</i>	Displays status information on process PID control. This parameter is read-only.	-																																													
<table border="1"> <thead> <tr> <th>Bit</th> <th>Name</th> <th>Value</th> </tr> </thead> <tbody> <tr> <td>0</td> <td>PID active</td> <td>1 = Process PID control active.</td> </tr> <tr> <td>1</td> <td>Setpoint frozen</td> <td>1 = Process PID setpoint frozen.</td> </tr> <tr> <td>2</td> <td>Output frozen</td> <td>1 = Process PID controller output frozen.</td> </tr> <tr> <td>3</td> <td>PID sleep mode</td> <td>1 = Sleep mode active.</td> </tr> <tr> <td>4</td> <td>Sleep boost</td> <td>1 = Sleep boost active.</td> </tr> <tr> <td>5</td> <td>Reserved</td> <td></td> </tr> <tr> <td>6</td> <td>Tracking mode</td> <td>1 = Tracking function active.</td> </tr> <tr> <td>7</td> <td>Output limit high</td> <td>1 = PID output is being limited by par. 40.37.</td> </tr> <tr> <td>8</td> <td>Output limit low</td> <td>1 = PID output is being limited by par. 40.36.</td> </tr> <tr> <td>9</td> <td>Deadband active</td> <td>1 = Feedback value is in the deadband range (40.39).</td> </tr> <tr> <td>10</td> <td>PID set</td> <td>0 = Parameter set 1 in use. 1 = Parameter set 2 in use.</td> </tr> <tr> <td>11</td> <td>Reserved</td> <td></td> </tr> <tr> <td>12</td> <td>Internal setpoint active</td> <td>1 = Internal setpoint active (see par. 40.16...40.23).</td> </tr> <tr> <td>13...15</td> <td>Reserved</td> <td></td> </tr> </tbody> </table>				Bit	Name	Value	0	PID active	1 = Process PID control active.	1	Setpoint frozen	1 = Process PID setpoint frozen.	2	Output frozen	1 = Process PID controller output frozen.	3	PID sleep mode	1 = Sleep mode active.	4	Sleep boost	1 = Sleep boost active.	5	Reserved		6	Tracking mode	1 = Tracking function active.	7	Output limit high	1 = PID output is being limited by par. 40.37.	8	Output limit low	1 = PID output is being limited by par. 40.36.	9	Deadband active	1 = Feedback value is in the deadband range (40.39).	10	PID set	0 = Parameter set 1 in use. 1 = Parameter set 2 in use.	11	Reserved		12	Internal setpoint active	1 = Internal setpoint active (see par. 40.16...40.23).	13...15	Reserved	
Bit	Name	Value																																														
0	PID active	1 = Process PID control active.																																														
1	Setpoint frozen	1 = Process PID setpoint frozen.																																														
2	Output frozen	1 = Process PID controller output frozen.																																														
3	PID sleep mode	1 = Sleep mode active.																																														
4	Sleep boost	1 = Sleep boost active.																																														
5	Reserved																																															
6	Tracking mode	1 = Tracking function active.																																														
7	Output limit high	1 = PID output is being limited by par. 40.37.																																														
8	Output limit low	1 = PID output is being limited by par. 40.36.																																														
9	Deadband active	1 = Feedback value is in the deadband range (40.39).																																														
10	PID set	0 = Parameter set 1 in use. 1 = Parameter set 2 in use.																																														
11	Reserved																																															
12	Internal setpoint active	1 = Internal setpoint active (see par. 40.16...40.23).																																														
13...15	Reserved																																															
	0000h...FFFFh	Process PID control status word.	1 = 1																																													
40.07	<i>Process PID operation mode</i>	Activates/deactivates process PID control. Note: Process PID control is only available in external control; see section <i>Local control vs. external control</i> (page 87).	<i>Off</i>																																													
	Off	Process PID control inactive.	0																																													
	On	Process PID control active.	1																																													
	On when drive running	Process PID control is active when the drive is running.	2																																													
40.08	<i>Set 1 feedback 1 source</i>	Selects the primary source of process feedback. See control chain diagram <i>PID setpoint compensation</i> on page 277.	<i>AI2 scaled</i>																																													
	Not selected	None.	0																																													
	AI1 scaled	<i>12.12 AI1 scaled value</i> (see page 321).	1																																													
	AI2 scaled	<i>12.22 AI2 scaled value</i> (see page 323).	2																																													
	Freq in scaled	<i>11.39 Freq in 1 scaled value</i> (see page 319).	3																																													
	Reserved		4...7																																													
	AI1 percent	<i>12.101 AI1 percent value</i> (see page 324).	8																																													
	AI2 percent	<i>12.102 AI2 percent value</i> (see page 324).	9																																													
	Feedback data storage	<i>40.91 Feedback data storage</i> (see page 452). (Selection not available for parameter 71.08 <i>Feedback 1 source</i> .)	10																																													
	Actual flow	Parameter <i>80.01 Actual flow</i> .	11																																													
	Actual flow %	Parameter <i>80.02 Actual flow</i> .	12																																													
	<i>Other</i>	Source selection (see <i>Terms and abbreviations</i> on page 285).	-																																													

No.	Name/Value	Description	Def/FbEq16
40.09	<i>Set 1 feedback 2 source</i>	Selects the second source of process feedback. The second source is used only if the setpoint function requires two inputs. For the selections, see parameter <i>40.08 Set 1 feedback 1 source</i> .	<i>Not selected</i>
40.10	<i>Set 1 feedback function</i>	Defines how process feedback is calculated from the two feedback sources selected by parameters <i>40.08 Set 1 feedback 1 source</i> and <i>40.09 Set 1 feedback 2 source</i> . The result of the function (for any selection) is multiplied by parameter <i>40.90 Set 1 feedback multiplier</i> . (That is why in selections 12 and 13, the multiplier k is constant 1.)	<i>In1</i>
	In1	Source 1.	0
	In1+In2	Sum of sources 1 and 2.	1
	In1-In2	Source 2 subtracted from source 1.	2
	In1*In2	Source 1 multiplied by source 2.	3
	In1/In2	Source 1 divided by source 2.	4
	MIN(In1,In2)	Smaller of the two sources.	5
	MAX(In1,In2)	Greater of the two sources.	6
	AVE(In1,In2)	Average of the two sources.	7
	sqrt(In1)	Square root of source 1.	8
	sqrt(In1-In2)	Square root of (source 1 - source 2).	9
	sqrt(In1+In2)	Square root of (source 1 + source 2).	10
	sqrt(In1)+sqrt(In2)	Square root of source 1 + square root of source 2.	11
	k*sqrt(In1)	Square root of source 1. (k = 1)	12
	k*sqrt(In1-In2)	Square root of (source 1 - source 2). (k = 1)	13
40.11	<i>Set 1 feedback filter time</i>	Defines the filter time constant for process feedback.	0.000 s
	0.000...30.000 s	Feedback filter time.	1 = 1 s
40.14	<i>Set 1 setpoint scaling</i>	Defines, together with parameter <i>40.15 Set 1 output scaling</i> , a general scaling factor for the process PID control chain. If the parameter is set to zero, automatic setpoint scaling is activated, where suitable setpoint scale is calculated according to selected setpoint source. Actual setpoint scale is shown in parameter <i>40.61 Setpoint scaling actual</i> . The scaling can be utilized when, for example, the process setpoint is input in Hz, and the output of the PID controller is used as an rpm value in speed control. In this case, this parameter might be set to 50, and parameter <i>40.15</i> to the nominal motor speed at 50 Hz. In effect, the output of the PID controller = [40.15] when deviation (setpoint - feedback) = [40.14] and [40.32] = 1. Note: The scaling is based on the ratio between <i>40.14</i> and <i>40.15</i> . For example, the values 50 and 1500 would produce the same scaling as 1 and 30.	0.00
	-200000.00... 200000.00	Process setpoint base.	1 = 1

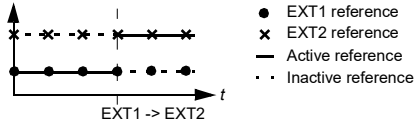
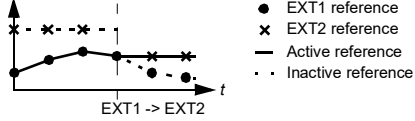
No.	Name/Value	Description	Def/FbEq16						
40.15	<i>Set 1 output scaling</i>	See parameter 40.14 Set 1 setpoint scaling . If the parameter is set to zero, scaling is automatic: <table border="1" data-bbox="348 236 840 339" style="margin: 10px auto;"> <thead> <tr> <th data-bbox="348 236 594 284">Operation mode (see par. 19.01)</th> <th data-bbox="594 236 840 284">Scaling</th> </tr> </thead> <tbody> <tr> <td data-bbox="348 284 594 312">Speed control</td> <td data-bbox="594 284 840 312">46.01 Speed scaling</td> </tr> <tr> <td data-bbox="348 312 594 339">Frequency control</td> <td data-bbox="594 312 840 339">46.02 Frequency scaling</td> </tr> </tbody> </table>	Operation mode (see par. 19.01)	Scaling	Speed control	46.01 Speed scaling	Frequency control	46.02 Frequency scaling	0.00
Operation mode (see par. 19.01)	Scaling								
Speed control	46.01 Speed scaling								
Frequency control	46.02 Frequency scaling								
	-200000.00... 200000.00	Process PID controller output base.	1 = 1						
40.16	<i>Set 1 setpoint 1 source</i>	Selects the primary source of process PID setpoint. See the control chain diagram on page 277 .	<i>Internal setpoint</i>						
	Not selected	None.	0						
	Reserved		1						
	Internal setpoint	Internal setpoint. See parameter 40.19 Set 1 internal setpoint sel1 .	2						
	AI1 scaled	12.12 AI1 scaled value (see page 321).	3						
	AI2 scaled	12.22 AI2 scaled value (see page 323).	4						
	Reserved		5...7						
	Motor potentiometer	22.80 Motor potentiometer ref act (output of the Motor potentiometer).	8						
	Reserved		9						
	Freq in scaled	11.39 Freq in 1 scaled value (see page 319).	10						
	AI1 percent	12.101 AI1 percent value (see page 324).	11						
	AI2 percent	12.102 AI2 percent value (see page 324).	12						
	Control panel (ref saved)	Control panel reference (03.01 Panel reference , see page 292) saved by the control system for the location where the control returns is used as the reference. (Selection not available for parameter 71.16 Setpoint 1 source .) <p data-bbox="348 1007 426 1026">Reference</p>  <ul style="list-style-type: none"> <li data-bbox="602 1034 745 1053">● EXT1 reference <li data-bbox="602 1054 745 1074">× EXT2 reference <li data-bbox="602 1075 745 1094">— Active reference <li data-bbox="602 1096 745 1115">· · Inactive reference 	13						
	Control panel (ref copied)	Control panel reference (03.01 Panel reference , see page 292) for the previous control location is used as the reference when the control location changes if the references for the two locations are of the same type (eg frequency/speed/torque/PID); otherwise, the actual signal is used as the new reference. <p data-bbox="348 1313 426 1332">Reference</p>  <ul style="list-style-type: none"> <li data-bbox="602 1340 745 1359">● EXT1 reference <li data-bbox="602 1361 745 1380">× EXT2 reference <li data-bbox="602 1382 745 1401">— Active reference <li data-bbox="602 1402 745 1422">· · Inactive reference 	14						

No.	Name/Value	Description	Def/FbEq16
	FB A ref1	03.05 FB A reference 1 (see page 292).	15
	FB A ref2	03.06 FB A reference 2 (see page 292).	16
	Reserved		17...18
	EFB ref1	03.09 EFB reference 1 (see page 293).	19
	EFB ref2	03.10 EFB reference 2 (see page 293).	20
	Reserved		21...23
	Setpoint data storage	40.92 Setpoint data storage (see page 452). (Selection not available for parameter 71.16 Setpoint 1 source .)	24
	Compensated setpoint	40.70 Compensated setpoint (see page 450).	25
	<i>Other</i>	Source selection (see Terms and abbreviations on page 285).	-
40.17	Set 1 setpoint 2 source	Selects the second source of process setpoint. The second source is used only if the setpoint function requires two inputs. For the selections, see parameter 40.16 Set 1 setpoint 1 source .	<i>Not selected</i>
40.18	Set 1 setpoint function	Selects a function between the setpoint sources selected by parameters 40.16 Set 1 setpoint 1 source and 40.17 Set 1 setpoint 2 source . The result of the function (for any selection) is multiplied by parameter 40.89 Set 1 setpoint multiplier . (That is why in selections 12 and 13, the multiplier k is constant 1.)	<i>In1</i>
	In1	Source 1.	0
	In1+In2	Sum of sources 1 and 2.	1
	In1-In2	Source 2 subtracted from source 1.	2
	In1*In2	Source 1 multiplied by source 2.	3
	In1/In2	Source 1 divided by source 2.	4
	MIN(In1,In2)	Smaller of the two sources.	5
	MAX(In1,In2)	Greater of the two sources.	6
	AVE(In1,In2)	Average of the two sources.	7
	sqrt(In1)	Square root of source 1.	8
	sqrt(In1-In2)	Square root of (source 1 - source 2).	9
	sqrt(In1+In2)	Square root of (source 1 + source 2).	10
	sqrt(In1)+sqrt(In2)	Square root of source 1 + square root of source 2.	11
	k*sqrt(In1)	Square root of source 1. (k = 1)	12
	k*sqrt(In1-In2)	Square root of (source 1 - source 2). (k = 1)	13

No.	Name/Value	Description	Def/FbEq16															
40.19	<i>Set 1 internal setpoint sel1</i>	Selects together with 40.20 Set 1 internal setpoint sel2 the internal setpoint out of the presets defined by parameters 40.21...40.24 . Note: Parameters 40.16 Set 1 setpoint 1 source and 40.17 Set 1 setpoint 2 source must be set to <i>Internal setpoint</i> .	<i>Selected</i>															
		<table border="1"> <thead> <tr> <th>Source defined by par. 40.19</th> <th>Source defined by par. 40.20</th> <th>Setpoint preset active</th> </tr> </thead> <tbody> <tr> <td>0</td> <td>0</td> <td>0 (par. 40.24)</td> </tr> <tr> <td>1</td> <td>0</td> <td>1 (par. 40.21)</td> </tr> <tr> <td>0</td> <td>1</td> <td>2 (par. 40.22)</td> </tr> <tr> <td>1</td> <td>1</td> <td>3 (par. 40.23)</td> </tr> </tbody> </table>		Source defined by par. 40.19	Source defined by par. 40.20	Setpoint preset active	0	0	0 (par. 40.24)	1	0	1 (par. 40.21)	0	1	2 (par. 40.22)	1	1	3 (par. 40.23)
		Source defined by par. 40.19		Source defined by par. 40.20	Setpoint preset active													
		0		0	0 (par. 40.24)													
		1		0	1 (par. 40.21)													
0	1	2 (par. 40.22)																
1	1	3 (par. 40.23)																
Not selected	0.	0																
Selected	1.	1																
DI1	Digital input DI1 (10.02 DI delayed status , bit 0).	2																
DI2	Digital input DI2 (10.02 DI delayed status , bit 1).	3																
DI3	Digital input DI3 (10.02 DI delayed status , bit 2).	4																
DI4	Digital input DI4 (10.02 DI delayed status , bit 3).	5																
DI5	Digital input DI5 (10.02 DI delayed status , bit 4).	6																
DI6	Digital input DI6 (10.02 DI delayed status , bit 5).	7																
Reserved		8...17																
Timed function 1	Bit 0 of 34.01 Timed functions status (see page 410).	18																
Timed function 2	Bit 1 of 34.01 Timed functions status (see page 410).	19																
Timed function 3	Bit 2 of 34.01 Timed functions status (see page 410).	20																
Supervision 1	Bit 0 of 32.01 Supervision status (see page 403).	21																
Supervision 2	Bit 1 of 32.01 Supervision status (see page 403).	22																
Supervision 3	Bit 2 of 32.01 Supervision status (see page 403).	23																
<i>Other [bit]</i>	Source selection (see Terms and abbreviations on page 285).	-																
40.20	<i>Set 1 internal setpoint sel2</i>	Selects together with 40.19 Set 1 internal setpoint sel1 the internal setpoint used out of the three internal setpoints defined by parameters 40.21...40.23 . See table at 40.19 Set 1 internal setpoint sel1 .	<i>Not selected</i>															
		Not selected		0.	0													
		Selected		1.	1													
		DI1		Digital input DI1 (10.02 DI delayed status , bit 0).	2													
		DI2		Digital input DI2 (10.02 DI delayed status , bit 1).	3													
		DI3		Digital input DI3 (10.02 DI delayed status , bit 2).	4													
		DI4		Digital input DI4 (10.02 DI delayed status , bit 3).	5													
		DI5		Digital input DI5 (10.02 DI delayed status , bit 4).	6													
		DI6		Digital input DI6 (10.02 DI delayed status , bit 5).	7													
		Reserved			8...17													
		Timed function 1		Bit 0 of 34.01 Timed functions status (see page 410).	18													
		Timed function 2		Bit 1 of 34.01 Timed functions status (see page 410).	19													
		Timed function 3		Bit 2 of 34.01 Timed functions status (see page 410).	20													

No.	Name/Value	Description	Def/FbEq16
	Supervision 1	Bit 0 of <i>32.01 Supervision status</i> (see page 403).	21
	Supervision 2	Bit 1 of <i>32.01 Supervision status</i> (see page 403).	22
	Supervision 3	Bit 2 of <i>32.01 Supervision status</i> (see page 403).	23
	<i>Other [bit]</i>	Source selection (see <i>Terms and abbreviations</i> on page 285).	-
40.21	<i>Set 1 internal setpoint 1</i>	Internal process setpoint 1. See parameter <i>40.19 Set 1 internal setpoint sel1</i> .	0.00 bar
	-200000.00... 200000.00 bar	Internal process setpoint 1.	1 = 1 bar
40.22	<i>Set 1 internal setpoint 2</i>	Internal process setpoint 2. See parameter <i>40.19 Set 1 internal setpoint sel1</i> .	0.00 bar
	-200000.00... 200000.00 bar	Internal process setpoint 2.	1 = 1 bar
40.23	<i>Set 1 internal setpoint 3</i>	Internal process setpoint 3. See parameter <i>40.19 Set 1 internal setpoint sel1</i> .	0.00 bar
	-200000.00... 200000.00 bar	Internal process setpoint 3.	1 = 1 bar
40.24	<i>Set 1 internal setpoint 0</i>	Internal process setpoint 0. See parameter <i>40.19 Set 1 internal setpoint sel1</i> .	0.00 bar
	-200000.00... 200000.00 bar	Internal process setpoint 0.	1 = 1 bar
40.26	<i>Set 1 setpoint min</i>	Defines a minimum limit for the process PID controller setpoint.	0.00 bar
	-200000.00... 200000.00 bar	Minimum limit for process PID controller setpoint.	1 = 1 bar
40.27	<i>Set 1 setpoint max</i>	Defines a maximum limit for the process PID controller setpoint.	5.00 bar
	-200000.00... 200000.00 bar	Maximum limit for process PID controller setpoint.	1 = 1 bar
40.28	<i>Set 1 setpoint increase time</i>	Defines the minimum time it takes for the setpoint to increase from 0% to 100%.	0.0 s
	0.0...32767.0 s	Setpoint increase time.	1 = 1
40.29	<i>Set 1 setpoint decrease time</i>	Defines the minimum time it takes for the setpoint to decrease from 100% to 0%.	0.0 s
	0.0...32767.0 s	Setpoint decrease time.	1 = 1
40.30	<i>Set 1 setpoint freeze enable</i>	Freezes, or defines a source that can be used to freeze, the setpoint of the process PID controller. This feature is useful when the reference is based on a process feedback connected to an analog input, and the sensor must be serviced without stopping the process. 1 = Process PID controller setpoint frozen See also parameter <i>40.38 Set 1 output freeze enable</i> .	<i>Not selected</i>
	Not selected	Process PID controller setpoint not frozen.	0
	Selected	Process PID controller setpoint frozen.	1
	DI1	Digital input DI1 (<i>10.02 DI delayed status</i> , bit 0).	2
	DI2	Digital input DI2 (<i>10.02 DI delayed status</i> , bit 1).	3
	DI3	Digital input DI3 (<i>10.02 DI delayed status</i> , bit 2).	4
	DI4	Digital input DI4 (<i>10.02 DI delayed status</i> , bit 3).	5

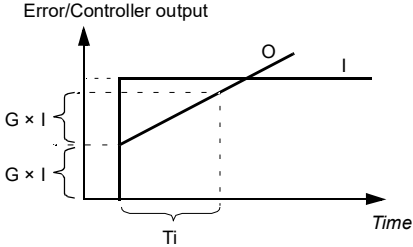
No.	Name/Value	Description	Def/FbEq16
	DI5	Digital input DI5 (<i>10.02 DI delayed status</i> , bit 4).	6
	DI6	Digital input DI6 (<i>10.02 DI delayed status</i> , bit 5).	7
	Reserved		8...17
	Timed function 1	Bit 0 of <i>34.01 Timed functions status</i> (see page 410).	18
	Timed function 2	Bit 1 of <i>34.01 Timed functions status</i> (see page 410).	19
	Timed function 3	Bit 2 of <i>34.01 Timed functions status</i> (see page 410).	20
	Supervision 1	Bit 0 of <i>32.01 Supervision status</i> (see page 403).	21
	Supervision 2	Bit 1 of <i>32.01 Supervision status</i> (see page 403).	22
	Supervision 3	Bit 2 of <i>32.01 Supervision status</i> (see page 403).	23
	<i>Other [bit]</i>	Source selection (see <i>Terms and abbreviations</i> on page 285).	-
40.31	<i>Set 1 deviation inversion</i>	Inverts the input of the process PID controller. 0 = Deviation not inverted (Deviation = Setpoint - Feedback) 1 = Deviation inverted (Deviation = Feedback - Setpoint) See also section <i>Sleep and boost functions for process PID control</i> (page 137).	<i>Not inverted (Ref - Fbk)</i>
	Not inverted (Ref - Fbk)	0.	0
	Inverted (Fbk - Ref)	1.	1
	<i>Other [bit]</i>	Source selection (see <i>Terms and abbreviations</i> on page 285).	-
40.32	<i>Set 1 gain</i>	Defines the gain for the process PID controller. See parameter <i>40.33 Set 1 integration time</i> .	1.00
	0.01...100.00	Gain for PID controller.	100 = 1
40.33	<i>Set 1 integration time</i>	Defines the integration time for the process PID controller. This time needs to be set to the same order of magnitude as the reaction time of the process being controlled, otherwise instability will result.  <p>I = controller input (error) O = controller output G = gain Ti = integration time</p> <p>Note: Setting this value to 0 disables the "I" part, turning the PID controller into a PD controller.</p>	10.0 s
	0.0...9999.0 s	Integration time.	1 = 1 s

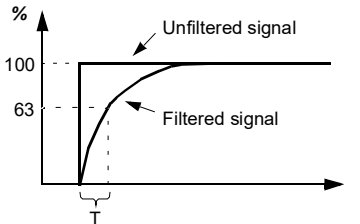
No.	Name/Value	Description	Def/FbEq16
40.34	<i>Set 1 derivation time</i>	Defines the derivation time of the process PID controller. The derivative component at the controller output is calculated on basis of two consecutive error values (E_{K-1} and E_K) according to the following formula: PID DERIV TIME $\times (E_K - E_{K-1})/T_S$, in which $T_S = 2$ ms sample time $E = \text{Error} = \text{Process reference} - \text{process feedback}$.	0.000 s
	0.000...10.000 s	Derivation time.	1000 = 1 s
40.35	<i>Set 1 derivation filter time</i>	Defines the time constant of the 1-pole filter used to smooth the derivative component of the process PID controller.  $O = I \times (1 - e^{-t/T})$ <p>$I = \text{filter input (step)}$ $O = \text{filter output}$ $t = \text{time}$ $T = \text{filter time constant}$</p>	0.0 s
	0.0...10.0 s	Filter time constant.	10 = 1 s
40.36	<i>Set 1 output min</i>	Defines the minimum limit for the process PID controller output. Using the minimum and maximum limits, it is possible to restrict the operation range.	0.00
	-200000.00... 200000.00	Minimum limit for process PID controller output.	1 = 1
40.37	<i>Set 1 output max</i>	Defines the maximum limit for the process PID controller output. See parameter 40.36 Set 1 output min .	100.00
	-200000.00... 200000.00	Maximum limit for process PID controller output.	1 = 1
40.38	<i>Set 1 output freeze enable</i>	Freezes (or defines a source that can be used to freeze) the output of the process PID controller, keeping the output at the value it was before freeze was enabled. This feature can be used when, for example, a sensor providing process feedback must be serviced without stopping the process. 1 = Process PID controller output frozen See also parameter 40.30 Set 1 setpoint freeze enable .	<i>Not selected</i>
	Not selected	Process PID controller output not frozen.	0
	Selected	Process PID controller output frozen.	1
	DI1	Digital input DI1 (10.02 DI delayed status , bit 0).	2
	DI2	Digital input DI2 (10.02 DI delayed status , bit 1).	3
	DI3	Digital input DI3 (10.02 DI delayed status , bit 2).	4
	DI4	Digital input DI4 (10.02 DI delayed status , bit 3).	5

No.	Name/Value	Description	Def/FbEq16
	DI5	Digital input DI5 (<i>10.02 DI delayed status</i> , bit 4).	6
	DI6	Digital input DI6 (<i>10.02 DI delayed status</i> , bit 5).	7
	Reserved		8...17
	Timed function 1	Bit 0 of <i>34.01 Timed functions status</i> (see page 410).	18
	Timed function 2	Bit 1 of <i>34.01 Timed functions status</i> (see page 410).	19
	Timed function 3	Bit 2 of <i>34.01 Timed functions status</i> (see page 410).	20
	Supervision 1	Bit 0 of <i>32.01 Supervision status</i> (see page 403).	21
	Supervision 2	Bit 1 of <i>32.01 Supervision status</i> (see page 403).	22
	Supervision 3	Bit 2 of <i>32.01 Supervision status</i> (see page 403).	23
	<i>Other [bit]</i>	Source selection (see <i>Terms and abbreviations</i> on page 285).	-
40.39	<i>Set 1 deadband range</i>	Defines a deadband around the setpoint. Whenever process feedback enters the deadband, a delay timer starts. If the feedback remains within the deadband longer than the delay (<i>40.40 Set 1 deadband delay</i>), the PID controller output is frozen. Normal operation resumes after the feedback value leaves the deadband.	0.0 bar
	0.0...200000.0	Deadband range.	1 = 1
40.40	<i>Set 1 deadband delay</i>	Delay for the deadband. See parameter <i>40.39 Set 1 deadband range</i> .	0.0 s
	0.0...3600.0 s	Delay for deadband area.	1 = 1 s
40.43	<i>Set 1 sleep level</i>	Defines the start limit for the sleep function. If the value is 0.0, set 1 sleep mode is disabled. The sleep function compares PID output (parameter <i>40.01 Process PID output actual</i>) to the value of this parameter. If PID output remains below this value longer than the sleep delay defined by <i>40.44 Set 1 sleep delay</i> , the drive enters the sleep mode and stops the motor.	0.0
	0.0...200000.0	Sleep start level.	1 = 1

No.	Name/Value	Description	Def/FbEq16
40.44	<i>Set 1 sleep delay</i>	Defines a delay before the sleep function actually becomes enabled, to prevent nuisance sleeping. The delay timer starts when the sleep mode is enabled by parameter 40.43 Set 1 sleep level , and resets when the sleep mode is disabled.	60.0 s
	0.0...3600.0 s	Sleep start delay.	1 = 1 s
40.45	<i>Set 1 sleep boost time</i>	Defines a boost time for the sleep boost step. See parameter 40.46 Set 1 sleep boost step .	0.0 s
	0.0...3600.0 s	Sleep boost time.	1 = 1 s
40.46	<i>Set 1 sleep boost step</i>	When the drive is entering sleep mode, the process setpoint is increased by this value for the time defined by parameter 40.45 Set 1 sleep boost time . If active, sleep boost is aborted when the drive wakes up.	0.0 bar
	0.0...200000.0 bar	Sleep boost step.	1 = 1 bar
40.47	<i>Set 1 wake-up deviation</i>	Defines the wake-up level as deviation between process setpoint and feedback. When the deviation exceeds the value of this parameter, and remains there for the duration of the wake-up delay (40.48 Set 1 wake-up delay), the drive wakes up. See also parameter 40.31 Set 1 deviation inversion .	0.00 bar
	-200000.00... 200000.00 bar	Wake-up level (as deviation between process setpoint and feedback).	1 = 1 bar
40.48	<i>Set 1 wake-up delay</i>	Defines a wake-up delay for the sleep function to prevent nuisance wake-ups. See parameter 40.47 Set 1 wake-up deviation . The delay timer starts when the deviation exceeds the wake-up level (40.47 Set 1 wake-up deviation), and resets if the deviation falls below the wake-up level.	0.50 s
	0.00...60.00 s	Wake-up delay.	1 = 1 s
40.49	<i>Set 1 tracking mode</i>	Activates (or selects a source that activates) tracking mode. In tracking mode, the value selected by parameter 40.50 Set 1 tracking ref selection is substituted for the PID controller output. See also section Tracking (page 139). 1 = Tracking mode enabled	<i>Not selected</i>
	Not selected	0.	0
	Selected	1.	1
	DI1	Digital input DI1 (10.02 DI delayed status , bit 0).	2
	DI2	Digital input DI2 (10.02 DI delayed status , bit 1).	3
	DI3	Digital input DI3 (10.02 DI delayed status , bit 2).	4
	DI4	Digital input DI4 (10.02 DI delayed status , bit 3).	5
	DI5	Digital input DI5 (10.02 DI delayed status , bit 4).	6
	DI6	Digital input DI6 (10.02 DI delayed status , bit 5).	7
	Reserved		8...17
	Timed function 1	Bit 0 of 34.01 Timed functions status (see page 410).	18
	Timed function 2	Bit 1 of 34.01 Timed functions status (see page 410).	19
	Timed function 3	Bit 2 of 34.01 Timed functions status (see page 410).	20
	Supervision 1	Bit 0 of 32.01 Supervision status (see page 403).	21
	Supervision 2	Bit 1 of 32.01 Supervision status (see page 403).	22

No.	Name/Value	Description	Def/FbEq16
	Supervision 3	Bit 2 of 32.01 Supervision status (see page 403).	23
	<i>Other [bit]</i>	Source selection (see Terms and abbreviations on page 285).	-
40.50	<i>Set 1 tracking ref selection</i>	Selects the value source for tracking mode. See parameter 40.49 Set 1 tracking mode .	<i>Not selected</i>
	Not selected	None.	0
	AI1 scaled	12.12 AI1 scaled value (see page 321).	1
	AI2 scaled	12.22 AI2 scaled value (see page 323).	2
	FB A ref1	03.05 FB A reference 1 (see page 292).	3
	FB A ref2	03.06 FB A reference 2 (see page 292).	4
	<i>Other</i>	Source selection (see Terms and abbreviations on page 285).	-
40.57	<i>PID set1/set2 selection</i>	Selects the source that determines whether process PID parameter set 1 (parameters 40.07...40.50) or set 2 (group 41 Process PID set 2) is used.	<i>PID set 1</i>
	PID set 1	0. Process PID parameter set 1 in use.	0
	PID set 2	1. Process PID parameter set 2 in use.	1
	DI1	Digital input DI1 (10.02 DI delayed status , bit 0).	2
	DI2	Digital input DI2 (10.02 DI delayed status , bit 1).	3
	DI3	Digital input DI3 (10.02 DI delayed status , bit 2).	4
	DI4	Digital input DI4 (10.02 DI delayed status , bit 3).	5
	DI5	Digital input DI5 (10.02 DI delayed status , bit 4).	6
	DI6	Digital input DI6 (10.02 DI delayed status , bit 5).	7
	Reserved		8...17
	Timed function 1	Bit 0 of 34.01 Timed functions status (see page 410).	18
	Timed function 2	Bit 1 of 34.01 Timed functions status (see page 410).	19
	Timed function 3	Bit 2 of 34.01 Timed functions status (see page 410).	20
	Supervision 1	Bit 0 of 32.01 Supervision status (see page 403).	21
	Supervision 2	Bit 1 of 32.01 Supervision status (see page 403).	22
	Supervision 3	Bit 2 of 32.01 Supervision status (see page 403).	23
	<i>Other [bit]</i>	Source selection (see Terms and abbreviations on page 285).	-
40.58	<i>Set 1 increase prevention</i>	Prevention of PID integration term increase for PID set 1.	<i>No</i>
	No	Increase prevention not in use.	0
	Limiting	The PID integration term is not increased if the maximum value for the PID output is reached. This parameter is valid for the PID set 1.	1
	Ext PID min lim	The process PID integration term is not increased when the output of the external PID has reached its minimum limit. In this setup, the external PID is used as a source for the process PID. This parameter is valid for the PID set 1.	2
	Ext PID max lim	The process PID integration term is not increased when the output of the external PID has reached its maximum limit. In this setup, the external PID is used as a source for the process PID. This parameter is valid for the PID set 1.	3
	<i>Other [bit]</i>	Source selection (see Terms and abbreviations on page 285).	-

No.	Name/Value	Description	Def/FbEq16
40.59	<i>Set 1 decrease prevention</i>	Prevention of PID integration term decrease for PID set 1.	No
	No	Decrease prevention not in use.	0
	Limiting	The PID integration term is not decreased if the minimum value for the PID output is reached. This parameter is valid for the PID set 1.	1
	Ext PID min lim	The process PID integration term is not decreased when the output of the external PID has reached its minimum limit. In this setup, the external PID is used as a source for the process PID. This parameter is valid for the PID set 1.	2
	Ext PID max lim	The process PID integration term is not decreased when the output of the external PID has reached its maximum limit. In this setup, the external PID is used as a source for the process PID. This parameter is valid for the PID set 1.	3
	<i>Other [bit]</i>	Source selection (see <i>Terms and abbreviations</i> on page 285).	-
40.60	<i>Set 1 PID activation source</i>	Selects a source that enables/disables process PID control. See also parameter <i>40.07 Process PID operation mode</i> . 0 = Process PID control disabled. 1 = Process PID control enabled.	On
	Off	0.	0
	On	1.	1
	Follow Ext1/Ext2 selection	Process PID control is disabled when external control location EXT1 is active, and enabled when external control location EXT2 is active. See also parameter <i>19.11 Ext1/Ext2 selection</i> .	2
	DI1	Digital input DI1 (<i>10.02 DI delayed status</i> , bit 0).	3
	DI2	Digital input DI2 (<i>10.02 DI delayed status</i> , bit 1).	4
	DI3	Digital input DI3 (<i>10.02 DI delayed status</i> , bit 2).	5
	DI4	Digital input DI4 (<i>10.02 DI delayed status</i> , bit 3).	6
	DI5	Digital input DI5 (<i>10.02 DI delayed status</i> , bit 4).	7
	DI6	Digital input DI6 (<i>10.02 DI delayed status</i> , bit 5).	8
	<i>Other [bit]</i>	Source selection (see <i>Terms and abbreviations</i> on page 285).	-
40.61	<i>Setpoint scaling actual</i>	Actual setpoint scaling. See parameter <i>40.14 Set 1 setpoint scaling</i> .	50.00
	-200000.00... 200000.00	Scaling.	1 = 1
40.62	<i>PID internal setpoint actual</i>	Displays the value of the internal setpoint. See control chain diagram <i>PID setpoint compensation</i> on page 277. This parameter is read-only.	-
	-200000.00... 200000.00 bar	Process PID internal setpoint.	1 = 1 bar

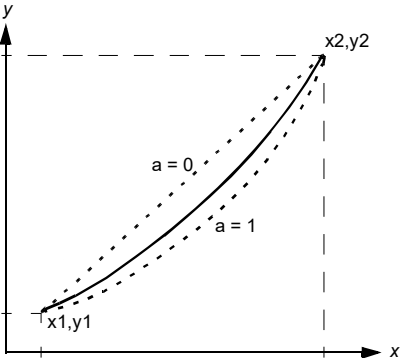
No.	Name/Value	Description	Def/FbEq16
40.70	<i>Compensated setpoint</i>	<p>Compensated setpoint determined for the input specified by parameter 40.71 Set 1 compensation input source.</p> <p>The determination of the compensated setpoint is based on the curve specified by points (x1, y1), (x2, y2) and the non-linearity of the curve specified with parameters 40.71...40.76. The compensated setpoint curve will be a mixture of a straight line between the points and a squared line between the points:</p>  <p>x = value from 40.71 Set 1 compensation input source y = 40.70 Compensated setpoint a = 40.76 Set 1 compensation non-linearity Compensated setpoint curve = a * squared function + (1 - a) * linear function</p>	-
	-21474836.48... 21474835.20 bar	Compensated setpoint value.	1 = 1 bar
40.71	<i>Set 1 compensation input source</i>	Selects the source for set 1 compensation input.	<i>Not selected</i>
	Not selected	None.	0
	Reserved		1
	Internal setpoint	Internal setpoint. See parameter 40.19 Set 1 internal setpoint sel1 .	2
	AI1 scaled	12.12 AI1 scaled value (see page 321).	3
	AI2 scaled	12.22 AI2 scaled value (see page 323).	4
	Reserved		5...7
	Motor potentiometer	22.80 Motor potentiometer ref act (output of the Motor potentiometer).	8
	Reserved		9
	Freq in scaled	11.39 Freq in 1 scaled value (see page 319).	10
	AI1 percent	12.101 AI1 percent value (see page 324).	11
	AI2 percent	12.102 AI2 percent value (see page 324).	12
	Reserved		13...14
	FB A ref1	03.05 FB A reference 1 (see page 292).	15
	FB A ref2	03.06 FB A reference 2 (see page 292).	16

No.	Name/Value	Description	Def/FbEq16
	Reserved		17...18
	EFB ref1	03.09 EFB reference 1 (see page 293).	19
	EFB ref2	03.10 EFB reference 2 (see page 293).	20
	Reserved		21...23
	Setpoint data storage	40.92 Setpoint data storage (see page 452).	24
	<i>Other</i>	Source selection (see Terms and abbreviations on page 285).	-
40.72	Set 1 compensation input 1	Point x1 on the setpoint compensation curve, see parameter 40.71 Compensated setpoint .	0.00
	-200000.00... 200000.00	Setpoint value.	1 = 1
40.73	Set 1 compensated output 1	Point y1 (= the compensated output of parameter 40.72 Set 1 compensation input 1) on the setpoint compensation curve, see parameter 40.70 Compensated setpoint .	0.00 bar
	-200000.00... 200000.00 bar	Compensated setpoint value.	1 = 1 bar
40.74	Set 1 compensation input 2	Point x2 on the setpoint compensation curve, see parameter 40.71 Compensated setpoint .	0.00
	-200000.00... 200000.00	Setpoint value.	1 = 1
40.75	Set 1 compensated output 2	Point y2 (= the compensated output of parameter 40.74 Set 1 compensation input 2) on the setpoint compensation curve, see parameter 40.70 Compensated setpoint .	0.00 bar
	-200000.00... 200000.00 bar	Compensated setpoint value.	1 = 1 bar
40.76	Set 1 compensation non-linearity	Describes the non-linearity of the setpoint compensation curve, see parameter 40.70 Compensated setpoint .	0%
	0...100%	Percentage.	1 = 1%
40.79	Set 1 units	Unit used for PID set 1.	<i>bar</i>
	User text	User editable text.	0
	%	Percent.	4
	bar	Bar.	74
	kPa	Kilo pascal.	75
	Pa	Pascal.	77
	psi	Pound per square inch.	76
	CFM	Cubic feet per minute.	26
	inH ₂ O	Inch of water.	58
	°C	Degree Celsius.	150
	°F	Degree Fahrenheit.	151
	mbar	Millibar.	44
	m ³ /h	Cubic meter per hour.	78
	dm ³ /h	Cubic decimeter per hour.	21
	l/s	Liter per second.	79

No.	Name/Value	Description	Def/FbEq16
	l/min	Liter per minute.	37
	l/h	Liter per hour.	38
	m ³ /s	Cubic meter per second.	88
	m ³ /min	Cubic meter per minute.	40
	km ³ /h	Cubic kilometer per minute.	131
	gal/s	Gallon per second.	47
	ft ³ /s	Cubic feet per second.	50
	ft ³ /min	Cubic feet per minute.	51
	ft ³ /h	Cubic feet per hour.	52
	ppm	Parts per million.	34
	inHg	Inch of mercury.	29
	kCFM	Cubic kilo feet per minute.	126
	inWC	Inch of water.	65
	gpm	Gallon per minute.	80
	gal/min	Gallon per minute.	48
	in wg	Inch water gauge.	59
	MPa	Megapascal.	94
	ftWC	Feet of water.	125
40.80	<i>Set 1 PID output min source</i>	Selects the source for set 1 PID output minimum.	<i>Set1 output min</i>
	None	Not selected.	0
	Set1 output min	40.36 Set 1 output min.	1
	<i>Other [bit]</i>	Source selection (see Terms and abbreviations on page 285).	-
40.81	<i>Set 1 PID output max source</i>	Selects the source for set 1 PID output maximum.	<i>Set1 output max</i>
	None	Not selected.	0
	Set1 output max	40.37 Set 1 output max.	1
	<i>Other [bit]</i>	Source selection (see Terms and abbreviations on page 285).	-
40.89	<i>Set 1 setpoint multiplier</i>	Defines the multiplier with which the result of the function specified by parameter 40.18 Set 1 setpoint function is multiplied.	1.00
	-200000.00... 200000.00	Multiplier.	1 = 1
40.90	<i>Set 1 feedback multiplier</i>	Defines the multiplier with which the result of the function specified by parameter 40.10 Set 1 feedback function is multiplied.	1.00
	-200000.00... 200000.00	Multiplier.	1 = 1
40.91	<i>Feedback data storage</i>	Storage parameter for receiving a process feedback value, for example, through the embedded fieldbus interface. The value can be sent to the drive as Modbus I/O data. Set the target selection parameter of that particular data (58.101...58.114) to Feedback data storage . In 40.08 Set 1 feedback 1 source (or 40.09 Set 1 feedback 2 source), select Feedback data storage .	0.00
	-327.68...327.67	Storage parameter for process feedback.	100 = 1

No.	Name/Value	Description	Def/FbEq16
40.92	<i>Setpoint data storage</i>	Storage parameter for receiving a process setpoint value, for example, through the embedded fieldbus interface. The value can be sent to the drive as Modbus I/O data. Set the target selection parameter of that particular data (58.101...58.114) to <i>Setpoint data storage</i> . In 40.16 Set 1 setpoint 1 source (or 40.17 Set 1 setpoint 2 source), select <i>Setpoint data storage</i> .	0.00
	-327.68...327.67	Storage parameter for process setpoint.	100 = 1
40.96	<i>Process PID output %</i>	Percentage scaled signal of parameter 40.01 <i>Process PID feedback actual</i> .	0.00%
	-100.00...100.00%	Percentage.	100 = 1%
40.97	<i>Process PID feedback %</i>	Percentage scaled signal of parameter 40.02 <i>Process PID feedback actual</i> .	0.00%
	-100.00...100.00%	Percentage.	100 = 1%
40.98	<i>Process PID setpoint %</i>	Percentage scaled signal of parameter 40.03 <i>Process PID setpoint actual</i> .	0.00%
	-100.00...100.00%	Percentage.	100 = 1%
40.99	<i>Process PID deviation %</i>	Percentage scaled signal of parameter 40.04 <i>Process PID deviation actual</i> .	0.00%
	-100.00...100.00%	Percentage.	100 = 1%
41 Process PID set 2		A second set of parameter values for process PID control. The selection between this set and first set (parameter group 40 Process PID set 1) is made by parameter 40.57 <i>PID set1/set2 selection</i> . See also parameters 40.01...40.06, and control chain diagram <i>PID setpoint compensation</i> on page 277.	
41.08	<i>Set 2 feedback 1 source</i>	See parameter 40.08 <i>Set 1 feedback 1 source</i> .	<i>A12 percent</i>
41.09	<i>Set 2 feedback 2 source</i>	See parameter 40.09 <i>Set 1 feedback 2 source</i> .	<i>Not selected</i>
41.10	<i>Set 2 feedback function</i>	See parameter 40.10 <i>Set 1 feedback function</i> .	<i>In1</i>
41.11	<i>Set 2 feedback filter time</i>	See parameter 40.11 <i>Set 1 feedback filter time</i> .	0.000 s
41.14	<i>Set 2 setpoint scaling</i>	See parameter 40.14 <i>Set 1 setpoint scaling</i> .	0.00
41.15	<i>Set 2 output scaling</i>	See parameter 40.15 <i>Set 1 output scaling</i> .	0.00
41.16	<i>Set 2 setpoint 1 source</i>	See parameter 40.16 <i>Set 1 setpoint 1 source</i> .	<i>Internal setpoint</i>
41.17	<i>Set 2 setpoint 2 source</i>	See parameter 40.17 <i>Set 1 setpoint 2 source</i> .	<i>Not selected</i>
41.18	<i>Set 2 setpoint function</i>	See parameter 40.18 <i>Set 1 setpoint function</i> .	<i>In1</i>
41.19	<i>Set 2 internal setpoint sel1</i>	See parameter 40.19 <i>Set 1 internal setpoint sel1</i> .	<i>Not selected</i>
41.20	<i>Set 2 internal setpoint sel2</i>	See parameter 40.20 <i>Set 1 internal setpoint sel2</i> .	<i>Not selected</i>

No.	Name/Value	Description	Def/FbEq16
41.21	Set 2 internal setpoint 1	See parameter 40.21 Set 1 internal setpoint 1.	0.00 bar
41.22	Set 2 internal setpoint 2	See parameter 40.22 Set 1 internal setpoint 2.	0.00 bar
41.23	Set 2 internal setpoint 3	See parameter 40.23 Set 1 internal setpoint 3.	0.00 bar
41.24	Set 2 internal setpoint 0	See parameter 40.24 Set 1 internal setpoint 0.	0.00 bar
41.26	Set 2 setpoint min	See parameter 40.26 Set 1 setpoint min.	0.00 bar
41.27	Set 2 setpoint max	See parameter 40.27 Set 1 setpoint max.	200000.00 bar
41.28	Set 2 setpoint increase time	See parameter 40.28 Set 1 setpoint increase time.	0.0 s
41.29	Set 2 setpoint decrease time	See parameter 40.29 Set 1 setpoint decrease time.	0.0 s
41.30	Set 2 setpoint freeze enable	See parameter 40.30 Set 1 setpoint freeze enable.	Not selected
41.31	Set 2 deviation inversion	See parameter 40.31 Set 1 deviation inversion.	Not inverted (Ref - Fbk)
41.32	Set 2 gain	See parameter 40.32 Set 1 gain.	1.00
41.33	Set 2 integration time	See parameter 40.33 Set 1 integration time.	60.0 s
41.34	Set 2 derivation time	See parameter 40.34 Set 1 derivation time.	0.000 s
41.35	Set 2 derivation filter time	See parameter 40.35 Set 1 derivation filter time.	0.0 s
41.36	Set 2 output min	See parameter 40.36 Set 1 output min.	0.00
41.37	Set 2 output max	See parameter 40.37 Set 1 output max.	100.00
41.38	Set 2 output freeze enable	See parameter 40.38 Set 1 output freeze enable.	Not selected
41.39	Set 2 deadband range	See parameter 40.39 Set 1 deadband range.	0.0 bar
41.40	Set 2 deadband delay	See parameter 40.40 Set 1 deadband delay.	0.0 s
41.43	Set 2 sleep level	See parameter 40.43 Set 1 sleep level.	0.0
41.44	Set 2 sleep delay	See parameter 40.44 Set 1 sleep delay.	60.0 s
41.45	Set 2 sleep boost time	See parameter 40.45 Set 1 sleep boost time.	0.0 s
41.46	Set 2 sleep boost step	See parameter 40.46 Set 1 sleep boost step.	0.0 bar
41.47	Set 2 wake-up deviation	See parameter 40.47 Set 1 wake-up deviation.	0.00 bar
41.48	Set 2 wake-up delay	See parameter 40.48 Set 1 wake-up delay.	0.50 s
41.49	Set 2 tracking mode	See parameter 40.49 Set 1 tracking mode.	Not selected
41.50	Set 2 tracking ref selection	See parameter 40.50 Set 1 tracking ref selection.	Not selected

No.	Name/Value	Description	Def/FbEq16
41.58	<i>Set 2 increase prevention</i>	See parameter <i>40.58 Set 1 increase prevention</i> .	No
41.59	<i>Set 2 decrease prevention</i>	See parameter <i>40.59 Set 1 decrease prevention</i> .	No
41.60	<i>Set 2 PID activation source</i>	See parameter <i>40.60 Set 1 PID activation source</i> .	On
41.71	<i>Set 2 compensation input source</i>	See parameter <i>40.71 Set 1 compensation input source</i> .	Not selected
41.72	<i>Set 2 compensation input 1</i>	See parameter <i>40.72 Set 1 compensation input 1</i> .	0.00
41.73	<i>Set 2 compensated output 1</i>	See parameter <i>40.73 Set 1 compensated output 1</i> .	0.00 bar
41.74	<i>Set 2 compensation input 2</i>	See parameter <i>40.74 Set 1 compensation input 2</i> .	0.00
41.75	<i>Set 2 compensated output 2</i>	See parameter <i>40.75 Set 1 compensated output 2</i> .	0.00 bar
41.76	<i>Set 2 compensation non-linearity</i>	See parameter <i>40.76 Set 1 compensation non-linearity</i> .	0%
41.79	<i>Set 2 units</i>	See parameter <i>40.79 Set 1 units</i> .	bar
41.80	<i>Set 2 PID output min source</i>	Selects the source for set 2 PID output minimum.	<i>Set2 output min</i>
	None	None.	0
	Set2 output min	<i>41.36 Set 2 output min</i> .	1
	<i>Other [bit]</i>	Source selection (see <i>Terms and abbreviations</i> on page 285).	-
41.81	<i>Set 2 PID output max source</i>	Selects the source for set 2 PID output maximum.	<i>Set2 output max</i>
	None	None.	0
	Set2 output max	<i>41.37 Set 2 output max</i> .	1
	<i>Other [bit]</i>	Source selection (see <i>Terms and abbreviations</i> on page 285).	-
41.89	<i>Set 2 setpoint multiplier</i>	See parameter <i>40.89 Set 1 setpoint multiplier</i> .	1.00
41.90	<i>Set 2 feedback multiplier</i>	Defines the multiplier k used in formulas of parameter <i>41.10 Set 2 feedback function</i> . See parameter <i>40.90 Set 1 feedback multiplier</i> .	1.00

No.	Name/Value	Description	Def/FbEq16
43 Brake chopper		Settings for the internal brake chopper. Note: These parameters apply to internal brake chopper only. When using external brake, you must disable brake chopper function by setting parameter 43.06 Brake chopper function to value <i>Disabled</i> .	
43.01 <i>Braking resistor temperature</i>	0.0...120.0%	Displays the estimated temperature of the brake resistor, or how close the brake resistor is to being too hot. The value is given in percent where 100% is the eventual temperature the resistor would reach when loaded long enough with its rated maximum load capacity (43.09 Brake resistor Pmax cont). The temperature calculation is based on the values of parameters 43.08 , 43.09 and 43.10 , and on the assumption that the resistor is installed as instructed by the manufacturer (ie it cools down as expected). This parameter is read-only.	-
43.06 <i>Brake chopper function</i>	Disabled	Enables brake chopper control and selects the brake resistor overload protection method (calculation or measurement). Note: Before enabling brake chopper control, ensure that <ul style="list-style-type: none"> • a brake resistor is connected • overvoltage control is switched off (parameter 30.30 Overvoltage control) • the supply voltage range (parameter 95.01 Supply voltage) has been selected correctly. Note: When using external brake chopper, set this parameter to value <i>Disabled</i> .	<i>Disabled</i>
	Enabled with thermal model	Brake chopper control disabled.	0
	Enabled without thermal model	Brake chopper control enabled with brake resistor protection based on the thermal model. If you select this, you must also specify the values needed by the model, ie, parameters 43.08 ... 43.12 . See the resistor data sheet.	1
	Overvoltage peak protection	Brake chopper control enabled without resistor overload protection based on the thermal model. This setting can be used, for example, if the resistor is equipped with a thermal switch that is wired to open the main contactor of the drive if the resistor overheats. For more information, see chapter <i>Resistor braking</i> in the <i>Hardware manual</i> of the drive.	2
		Brake chopper control enabled in an overvoltage condition. This setting is intended for situations where <ul style="list-style-type: none"> • the braking chopper is not needed for runtime operation, ie, to dissipate the inertial energy of the motor, • the motor is able to store a considerable amount magnetic energy in its windings, and • the motor might, deliberately or inadvertently, be stopped by coasting. In such a situation, the motor would potentially discharge enough magnetic energy towards the drive to cause damage. To protect the drive, the brake chopper can be used with a small resistor dimensioned merely to handle the magnetic energy (not the inertial energy) of the motor. With this setting, the brake chopper is activated only whenever the DC voltage exceeds the overvoltage limit. During normal use, the brake chopper is not operating.	3

No.	Name/Value	Description	Def/FbEq16
43.07	<i>Brake chopper run enable</i>	Selects the source for quick brake chopper on/off control. 0 = Brake chopper IGBT pulses are cut off 1 = Normal brake chopper IGBT modulation allowed.	On
	Off	0.	0
	On	1.	1
	<i>Other [bit]</i>	Source selection (see <i>Terms and abbreviations</i> on page 285).	-
43.08	<i>Brake resistor thermal tc</i>	Defines the thermal time constant for the brake resistor thermal model.	0 s
	0...10000 s	Brake resistor thermal time constant, ie, the rated time to achieve 63% temperature.	1 = 1 s
43.09	<i>Brake resistor Pmax cont</i>	Defines the maximum continuous load of the brake resistor that will eventually raise the resistor temperature to the maximum allowed value (= continuous heat dissipation capacity of the resistor in kW) but not above it. The value is used in the resistor overload protection based on the thermal model. See parameter <i>43.06 Brake chopper function</i> and the data sheet of the brake resistor used.	0.00 kW
	0.00... 10000.00 kW	Maximum continuous load of the brake resistor.	1000 = 1 kW
43.10	<i>Brake resistance</i>	Defines the resistance value of the brake resistor. The value is used for the brake resistor protection based on the thermal model. See parameter <i>43.06 Brake chopper function</i> .	0.0 ohm
	0.0...1000.0 ohm	Brake resistor resistance value.	1000 = 1 ohm
43.11	<i>Brake resistor fault limit</i>	Defines the fault limit for the brake resistor protection based on the thermal model. See parameter <i>43.06 Brake chopper function</i> . When the limit is exceeded, the drive trips on fault <i>7183 BR excess temperature</i> . The value is given in percent of the temperature the resistor reaches when loaded with the power defined by parameter <i>43.09 Brake resistor Pmax cont</i> .	105%
	0...150%	Brake resistor temperature fault limit.	100= 1%
43.12	<i>Brake resistor warning limit</i>	Defines the warning limit for the brake resistor protection based on the thermal model. See parameter <i>43.06 Brake chopper function</i> . When the limit is exceeded, the drive generates warning <i>A793 BR excess temperature</i> . The value is given in percent of the temperature the resistor reaches when loaded with the power defined by parameter <i>43.09 Brake resistor Pmax cont</i> .	95%
	0...150%	Brake resistor temperature warning limit.	100 = 1%
45 Energy efficiency		Settings for the energy saving calculators as well as peak and energy loggers. See also section <i>Diagnostics menu</i> (page 181).	
45.01	<i>Saved GW hours</i>	Energy saved in GWh compared to direct-on-line motor connection. This parameter is incremented when <i>45.02 Saved MW hours</i> rolls over. This parameter is read-only (see parameter <i>45.21 Energy calculations reset</i>).	-
	0...65535 GWh	Energy savings in GWh.	1 = 1 GWh

No.	Name/Value	Description	Def/FbEq16
45.02	<i>Saved MW hours</i>	Energy saved in MWh compared to direct-on-line motor connection. This parameter is incremented when 45.03 Saved kW hours rolls over. When this parameter rolls over, parameter 45.01 Saved GW hours is incremented. This parameter is read-only (see parameter 45.21 Energy calculations reset).	-
	0...999 MWh	Energy savings in MWh.	1 = 1 MWh
45.03	<i>Saved kW hours</i>	Energy saved in kWh compared to direct-on-line motor connection. If the internal brake chopper of the drive is enabled, all energy fed by the motor to the drive is assumed to be converted into heat, but the calculation still records savings made by controlling the speed. If the chopper is disabled, then regenerated energy from the motor is also recorded here. When this parameter rolls over, parameter 45.02 Saved MW hours is incremented. This parameter is read-only (see parameter 45.21 Energy calculations reset).	-
	0.0...999.9 kWh	Energy savings in kWh.	10 = 1 kWh
45.04	<i>Saved energy</i>	Energy saved in kWh compared to direct-on-line motor connection. If the internal brake chopper of the drive is enabled, all energy fed by the motor to the drive is assumed to be converted into heat. This parameter is read-only (see parameter 45.21 Energy calculations reset).	-
	0.0...214748368.0 kWh	Energy savings in kWh.	1 = 1 kWh
45.05	<i>Saved money x1000</i>	Monetary savings in thousands compared to direct-on-line motor connection. This parameter is incremented when 45.06 Saved money rolls over. If you have not set the currency during the first start-up, you can specify it in Main menu > Primary settings > Clock, region display > Units > Currency . This parameter is read-only (see parameter 45.21 Energy calculations reset).	-
	0...4294967295 thousands (unit x 1000)	Monetary savings in thousands of units.	
45.06	<i>Saved money</i>	Monetary savings compared to direct-on-line motor connection. This value is a calculated by multiplying the saved energy in kWh by the currently active energy tariff (45.14 Tariff selection). When this parameter rolls over, parameter 45.05 Saved money x1000 is incremented. If you have not set the currency during the first start-up, you can specify it in Main menu > Primary settings > Clock, region display > Units > Currency . This parameter is read-only (see parameter 45.21 Energy calculations reset).	-
	0.00...999.99 units	Monetary savings.	1 = 1 unit

No.	Name/Value	Description	Def/FbEq16
45.07	<i>Saved amount</i>	Monetary savings compared to direct-on-line motor connection. This value is calculated by multiplying the saved energy in kWh by the currently active energy tariff (45.14 <i>Tariff selection</i>). If you have not set the currency during the first start-up, you can specify it in Main menu > Primary settings > Clock, region display > Units > Currency . This parameter is read-only (see parameter 45.21 <i>Energy calculations reset</i>).	-
	0.00...21474830.0 units	Monetary savings.	1 = 1 unit
45.08	<i>CO2 reduction in kilotons</i>	Reduction in CO ₂ emissions in metric kilotons compared to direct-on-line motor connection. This value is incremented when parameter 45.09 <i>CO2 reduction in tons</i> rolls over. This parameter is read-only (see parameter 45.21 <i>Energy calculations reset</i>).	-
	0...65535 metric kilotons	Reduction in CO ₂ emissions in metric kilotons.	1 = 1 metric kiloton
45.09	<i>CO2 reduction in tons</i>	Reduction in CO ₂ emissions in metric tons compared to direct-on-line motor connection. This value is calculated by multiplying the saved energy in MWh by the value of parameter 45.18 <i>CO2 conversion factor</i> (by default, 0.5 metric tons/MWh). When this parameter rolls over, parameter 45.08 <i>CO2 reduction in kilotons</i> is incremented. This parameter is read-only (see parameter 45.21 <i>Energy calculations reset</i>).	-
	0.0...999.9 metric tons	Reduction in CO ₂ emissions in metric tons.	1 = 1 metric ton
45.10	<i>Total saved CO2</i>	Reduction in CO ₂ emissions in metric tons compared to direct-on-line motor connection. This value is calculated by multiplying the saved energy in MWh by the value of parameter 45.18 <i>CO2 conversion factor</i> (by default, 0.5 metric tons/MWh). This parameter is read-only (see parameter 45.21 <i>Energy calculations reset</i>).	-
	0.0...214748304.0 metric tons	Reduction in CO ₂ emissions in metric tons.	1 = 1 metric ton
45.11	<i>Energy optimizer</i>	Enables/disables the energy optimization function. The function optimizes the motor flux so that total energy consumption and motor noise level are reduced when the drive operates below the nominal load. The total efficiency (motor and drive) can be improved by 1...20% depending on load torque and speed. Note: With a permanent magnet motor and a synchronous reluctance motor, energy optimization is always enabled regardless of this parameter.	<i>Disable</i>
	Disable	Energy optimization disabled.	0
	Enable	Energy optimization enabled.	1

No.	Name/Value	Description	Def/FbEq16
45.12	Energy tariff 1	Defines energy tariff 1 (price of energy per kWh). Depending on the setting of parameter 45.14 Tariff selection , either this value or 45.13 Energy tariff 2 is used for reference when monetary savings are calculated. If you have not set the currency during the first start-up, you can specify it in Main menu > Primary settings > Clock, region display > Units > Currency . Note: Tariffs are read only at the instant of selection, and are not applied retroactively.	0.100 units
	0.000... 4294966.296 units	Energy tariff 1.	
45.13	Energy tariff 2	Defines energy tariff 2 (price of energy per kWh). See parameter 45.12 Energy tariff 1 .	0.200 units
	0.000... 4294966.296 units	Energy tariff 2.	
45.14	Tariff selection	Selects (or defines a source that selects) which pre-defined energy tariff is used. 0 = 45.12 Energy tariff 1 . 1 = 45.13 Energy tariff 2 .	Energy tariff 1
	Energy tariff 1	0.	0
	Energy tariff 2	1.	1
	DI1	Digital input DI1 (10.02 DI delayed status , bit 0).	2
	DI2	Digital input DI2 (10.02 DI delayed status , bit 1).	3
	DI3	Digital input DI3 (10.02 DI delayed status , bit 2).	4
	DI4	Digital input DI4 (10.02 DI delayed status , bit 3).	5
	DI5	Digital input DI5 (10.02 DI delayed status , bit 4).	6
	DI6	Digital input DI6 (10.02 DI delayed status , bit 5).	7
	Other [bit]	Source selection (see Terms and abbreviations on page 285).	-
45.18	CO2 conversion factor	Defines a factor for conversion of saved energy into CO ₂ emissions (kg/kWh or tn/MWh).	0.500 tn/MWh (metric ton)
	0.000...65.535 tn/MWh	Factor for conversion of saved energy into CO ₂ emissions.	1 = 1 tn/MWh
45.19	Comparison power	Actual power that the motor absorbs when connected direct-on-line and operating the application. The value is used for reference when energy savings are calculated. Note: The accuracy of the energy savings calculation is directly dependent on the accuracy of this value. If nothing is entered here, then the nominal motor power is used by the calculation, but that may inflate the energy savings reported as many motors do not absorb nameplate power.	0.75 kW
	0.00...10000000.0 0 kW	Motor power.	1 = 1 kW
45.21	Energy calculations reset	Resets the savings counter parameters 45.01...45.10 .	Done
	Done	Reset not requested (normal operation), or reset complete.	0
	Reset	Reset the savings counter parameters. The value reverts automatically to Done .	1

No.	Name/Value	Description	Def/FbEq16
45.24	<i>Hourly peak power value</i>	Value of the peak power during the last hour, that is, the most recent 60 minutes after the drive has been powered up. The parameter is updated once every 10 minutes unless the hourly peak is found in the most recent 10 minutes. In that case, the values is shown immediately.	0.00 kW
	-3000.00... 3000.00 kW	Peak power value.	10 = 1 kW
45.25	<i>Hourly peak power time</i>	Time of the peak power value during the last hour.	00:00:00
		Time.	N/A
45.26	<i>Hourly total energy (resettable)</i>	Total energy consumption during the last hour, that is, the most recent 60 minutes. You can reset the value by setting it to zero.	0.00 kWh
	-3000.00... 3000.00 kWh	Total energy.	10 = 1 kWh
45.27	<i>Daily peak power value (resettable)</i>	Value of the peak power since midnight of the present day. You can reset the value by setting it to zero.	0.00 kW
	-3000.00... 3000.00 kW	Peak power value.	10 = 1 kW
45.28	<i>Daily peak power time</i>	Time of the peak power since midnight of the present day.	00:00:00
		Time.	N/A
45.29	<i>Daily total energy (resettable)</i>	Total energy consumption since midnight of the present day. You can reset the value by setting it to zero.	0.00 kWh
	-30000.00... 30000.00 kWh	Total energy.	1 = 1 kWh
45.30	<i>Last day total energy</i>	Total energy consumption during the previous day, that is, between midnight of the previous day and midnight of the present day	0.00 kWh
	-30000.00... 30000.00 kWh	Total energy.	1 = 1 kWh
45.31	<i>Monthly peak power value (resettable)</i>	Value of the peak power during the present month, that is, since midnight of the first day of the present month. You can reset the value by setting it to zero.	0.00 kW
	-30000.00... 30000.00 kWh	Peak power value.	10 = 1 kW
45.32	<i>Monthly peak power date</i>	Date of the peak power during the present month.	1.1.1980
		Date.	N/A
45.33	<i>Monthly peak power time</i>	Time of the peak power during the present month.	00:00:00
		Time.	N/A
45.34	<i>Monthly total energy (resettable)</i>	Total energy consumption from the beginning of the present month. You can reset the value by setting it to zero.	0.00 kWh
	-1000000.00... 1000000.00 kWh	Total energy.	1 = 100 kWh

No.	Name/Value	Description	Def/FbEq16
45.35	<i>Last month total energy</i>	Total energy consumption during the previous month, that is, between midnight of the first day of the previous month and midnight of the first day of the present month.	0.00 kWh
	-1000000.00... 1000000.00 kWh		1 = 100 kWh
45.36	<i>Lifetime peak power value</i>	Value of the peak power over the drive lifetime.	0.00 kW
	-3000.00... 3000.00 kW	Peak power value.	10 = 1 kW
45.37	<i>Lifetime peak power date</i>	Date of the peak power over the drive lifetime.	1.1.1980
		Date.	N/A
45.38	<i>Lifetime peak power time</i>	Time of the peak power over the drive lifetime.	00:00:00
		Time.	N/A
46 Monitoring/scaling settings		Speed supervision settings; actual signal filtering; general scaling settings.	
46.01	<i>Speed scaling</i>	Defines the maximum speed value used to define the acceleration ramp rate and the initial speed value used to define the deceleration ramp rate (see parameter group 23 Speed reference ramp). The speed acceleration and deceleration ramp times are therefore related to this value (not to parameter 30.12 Maximum speed). Also defines the 16-bit scaling of speed-related parameters. The value of this parameter corresponds to 20000, for example, in fieldbus communication.	1500.00 rpm; 1800.00 rpm (95.20 b0)
	0.10...30000.00 rpm	Acceleration/deceleration terminal/initial speed.	1 = 1 rpm
46.02	<i>Frequency scaling</i>	Defines the maximum frequency value used to define the acceleration ramp rate and the initial frequency value used to define deceleration ramp rate (see parameter group 28 Frequency reference chain). The frequency acceleration and deceleration ramp times are therefore related to this value (not to parameter 30.14 Maximum frequency). Also defines the 16-bit scaling of frequency-related parameters. The value of this parameter corresponds to 20000, for example, in fieldbus communication.	50.00 Hz; 60.00 Hz (95.20 b0)
	0.10...1000.00 Hz	Acceleration/deceleration terminal/initial frequency.	10 = 1 Hz
46.03	<i>Torque scaling</i>	Defines the 16-bit scaling of torque parameters. The value of this parameter (in percent of nominal motor torque) corresponds to 10000, for example, in fieldbus communication.	100.0%
	0.1...1000.0%	Torque corresponding to 10000 on fieldbus.	10 = 1%
46.04	<i>Power scaling</i>	Defines the 16-bit scaling of power parameters. The value of this parameter corresponds to 10000, for example, in fieldbus communication. The unit is selected by parameter 96.16 Unit selection . For 32-bit scaling see parameter 46.43 Power decimals .	1000.00 unit
	0.10...30000.00 kW or 0.10...40214.48 hp	Power corresponding to 10000 on fieldbus.	1 = 1 unit

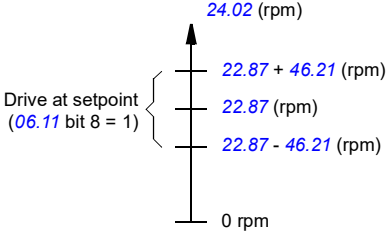
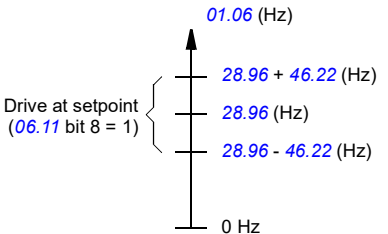

No.	Name/Value	Description	Def/FbEq16
46.05	<i>Current scaling</i>	Defines the 16-bit scaling of current parameters. The value of this parameter corresponds to 10000, for example, in fieldbus communication. For 32-bit scaling see parameter 46.44 Current decimals .	10000 A
	0...30000 A	Current corresponding to 10000 on fieldbus.	1 = 1 A
46.06	<i>Speed ref zero scaling</i>	Defines a speed corresponding to a zero reference received from fieldbus (either the embedded fieldbus interface, or interface FBA A). For example, with a setting of 500, the fieldbus reference range of 0...20000 would correspond to a speed of 500... [46.01] rpm. Note: This parameter is effective only with the ABB Drives communication profile.	0.00 rpm
	0.00...30000.00 rpm	Speed corresponding to minimum fieldbus reference.	1 = 1 rpm
46.07	<i>Frequency ref zero scaling</i>	Defines a frequency corresponding to a zero reference received from fieldbus (either the embedded fieldbus interface, or interface FBA). For example, with a setting of 30, the fieldbus reference range of 0...20000 would correspond to a speed of 30... [46.02] Hz. Note: This parameter is effective only with the ABB Drives communication profile.	0.00 Hz
	0.00...1000.00 Hz	Frequency corresponding to minimum fieldbus reference.	10 = 1 Hz
46.11	<i>Filter time motor speed</i>	Defines a filter time for signals 01.01 Motor speed used and 01.02 Motor speed estimated .	500 ms
	2...20000 ms	Motor speed signal filter time.	1 = 1 ms
46.12	<i>Filter time output frequency</i>	Defines a filter time for signal 01.06 Output frequency .	500 ms
	2...20000 ms	Output frequency signal filter time.	1 = 1 ms
46.13	<i>Filter time motor torque</i>	Defines a filter time for signal 01.10 Motor torque .	100 ms
	2...20000 ms	Motor torque signal filter time.	1 = 1 ms
46.14	<i>Filter time power</i>	Defines a filter time for signal 01.14 Output power .	100 ms
	2...20000 ms	Output power signal filter time.	1 = 1 ms



No.	Name/Value	Description	Def/FbEq16
46.21	<i>At speed hysteresis</i>	<p>Defines the “at setpoint” limits for speed control of the drive. When the difference between reference (22.87 Speed reference act 7) and the speed (24.02 Used speed feedback) is smaller than 46.21 At speed hysteresis, the drive is considered to be “at setpoint”. This is indicated by bit 8 of 06.11 Main status word.</p> 	50.00 rpm
	0.00...30000.00 rpm	Limit for “at setpoint” indication in speed control.	See par. 46.01
46.22	<i>At frequency hysteresis</i>	<p>Defines the “at setpoint” limits for frequency control of the drive. When the absolute difference between reference (28.96 Frequency ref ramp input) and actual frequency (01.06 Output frequency) is smaller than 46.22 At frequency hysteresis, the drive is considered to be “at setpoint”. This is indicated by bit 8 of 06.11 Main status word.</p> 	2.00 Hz
	0.00...1000.00 Hz	Limit for “at setpoint” indication in frequency control.	See par. 46.02
46.31	<i>Above speed limit</i>	<p>Defines the trigger level for “above limit” indication in speed control. When actual speed exceeds the limit, bit 10 of 06.17 Drive status word 2 is set. This is also indicated by bit 10 in 06.11 Main status word.</p>	1500.00 rpm; 1800.00 rpm (95.20 b0)
	0.00...30000.00 rpm	“Above limit” indication trigger level for speed control.	See par. 46.01
46.32	<i>Above frequency limit</i>	<p>Defines the trigger level for “above limit” indication in frequency control. When actual frequency exceeds the limit, bit 10 of 06.17 Drive status word 2 is set. This is also indicated by bit 10 in 06.11 Main status word.</p>	50.00 Hz; 60.00 Hz (95.20 b0)
	0.00...1000.00 Hz	“Above limit” indication trigger level for frequency control.	See par. 46.02
46.41	<i>kWh pulse scaling</i>	<p>Defines the trigger level for the “kWh pulse” on for 50 ms. The output of the pulse is bit 9 of 05.22 Diagnostic word 3.</p>	1.000 kWh

No.	Name/Value	Description	Def/FbEq16
	0.001... 1000.000 kWh	"kWh pulse" on trigger level.	1 = 1 kWh
46.43	<i>Power decimals</i>	Defines the number of decimals shown for parameter 99.10 Motor nominal power on the control panel and Drive composer PC tool. It also defines 32-bit scaling of power parameters. The value of this parameter corresponds to the number of decimals assumed in the 32-bit integer fieldbus communication. For 16-bit scaling, see parameter 46.04 Power scaling .	2
	0...3	Number of decimals.	1 = 1
46.44	<i>Current decimals</i>	Defines the number of decimals shown for parameter 99.06 Motor nominal current on the control panel and Drive composer PC tool. It also defines 32-bit scaling of current parameters. The value of this parameter corresponds to the number of decimals assumed in the 32-bit integer fieldbus communication. For 16-bit scaling, see parameter 46.05 Current scaling .	1
	0...3	Number of decimals.	1 = 1

47 Data storage		Data storage parameters that can be written to and read from using other parameters' source and target settings. Note that there are different storage parameters for different data types. See also section Data storage parameters (page 183).	
47.01	<i>Data storage 1 real32</i>	Data storage parameter 1.	0.000
	-2147483.000... 2147483.000	32-bit data.	
47.02	<i>Data storage 2 real32</i>	Data storage parameter 2.	0.000
	-2147483.000... 2147483.000	32-bit data.	
47.03	<i>Data storage 3 real32</i>	Data storage parameter 3.	0.000
	-2147483.000... 2147483.000	32-bit data.	
47.04	<i>Data storage 4 real32</i>	Data storage parameter 4.	0.000
	-2147483.000... 2147483.000	32-bit data.	
47.11	<i>Data storage 1 int32</i>	Data storage parameter 9.	0
	-2147483648... 2147483647	32-bit data.	
47.12	<i>Data storage 2 int32</i>	Data storage parameter 10.	0
	-2147483648... 2147483647	32-bit data.	

No.	Name/Value	Description	Def/FbEq16
47.13	<i>Data storage 3</i> <i>int32</i>	Data storage parameter 11.	0
	-2147483648... 2147483647	32-bit data.	
47.14	<i>Data storage 4</i> <i>int32</i>	Data storage parameter 12.	0
	-2147483648... 2147483647	32-bit data.	
47.21	<i>Data storage 1</i> <i>int16</i>	Data storage parameter 17.	0
	-32768...32767	16-bit data.	1 = 1
47.22	<i>Data storage 2</i> <i>int16</i>	Data storage parameter 18.	0
	-32768...32767	16-bit data.	1 = 1
47.23	<i>Data storage 3</i> <i>int16</i>	Data storage parameter 19.	0
	-32768...32767	16-bit data.	1 = 1
47.24	<i>Data storage 4</i> <i>int16</i>	Data storage parameter 20.	0
	-32768...32767	16-bit data.	1 = 1
49 Panel port communication		Communication settings for the control panel port on the drive.	
49.01	<i>Node ID number</i>	Defines the node ID of the drive. All devices connected to the network must have a unique node ID. Note: For networked drives, it is advisable to reserve ID 1 for spare/replacement drives.	1
	1...32	Node ID.	1 = 1
49.03	<i>Baud rate</i>	Defines the transfer rate of the link.	<i>115.2 kbps</i>
	38.4 kbps	38.4 kbit/s.	1
	57.6 kbps	57.6 kbit/s.	2
	86.4 kbps	86.4 kbit/s.	3
	115.2 kbps	115.2 kbit/s.	4
	230.4 kbps	230.4 kbit/s.	5
49.04	<i>Communication loss time</i>	Sets a timeout for control panel (or PC tool) communication. If a communication break lasts longer than the timeout, the action specified by parameter <i>49.05 Communication loss action</i> is taken.	10.0 s
	0.3...3000.0 s	Control panel/PC tool communication timeout.	10 = 1 s
49.05	<i>Communication loss action</i>	Selects how the drive reacts to a control panel (or PC tool) communication break.	<i>Fault</i>
	No action	No action taken.	0
	Fault	Drive trips on fault <i>7081 Control panel loss</i> .	1

No.	Name/Value	Description	Def/FbEq16
	Last speed	Drive generates warning <i>A7EE Panel loss</i> and freezes the speed to the level the drive was operating at. The speed is determined on the basis of actual speed using 850 ms low-pass filtering.  WARNING! Make sure that it is safe to continue operation in case of a communication break.	2
	Speed ref safe	Drive generates warning <i>A7EE Panel loss</i> and sets the speed to the speed defined by parameter <i>22.41 Speed ref safe</i> (or <i>28.41 Frequency ref safe</i> when frequency reference is being used).  WARNING! Make sure that it is safe to continue operation in case of a communication break.	3
<i>49.06</i>	<i>Refresh settings</i>	Applies the settings of parameters <i>49.01...49.05</i> . Note: Refreshing may cause a communication break, so reconnecting the drive may be required.	<i>Done</i>
	Done	Refresh done or not requested.	0
	Configure	Refresh parameters <i>49.01...49.05</i> . The value reverts automatically to <i>Done</i> .	1

50 Fieldbus adapter (FBA)		Fieldbus communication configuration. See also chapter <i>Fieldbus control through a fieldbus adapter</i> (page 253).	
<i>50.01</i>	<i>FBA A enable</i>	Enables/disables communication between the drive and fieldbus adapter A, and specifies the slot the adapter is installed into.	<i>Disable</i>
	Disable	Communication between drive and fieldbus adapter A disabled.	0
	Enable	Communication between drive and fieldbus adapter A enabled. The adapter is in slot 1.	1
<i>50.02</i>	<i>FBA A comm loss func</i>	Selects how the drive reacts upon a fieldbus communication break. The time delay is defined by parameter <i>50.03 FBA A comm loss t out</i> .	<i>No action</i>
	No action	No action taken.	0
	Fault	Drive trips on fault <i>7510 FBA A communication</i> . This only occurs if control is expected from the fieldbus (FBA A selected as source of start/stop/reference in the currently active control location).	1
	Last speed	Drive generates warning <i>A7C1 FBA A communication</i> and freezes the speed to the level the drive was operating at. This only occurs if control is expected from the fieldbus. The speed is determined on the basis of actual speed using 850 ms low-pass filtering.  WARNING! Make sure that it is safe to continue operation in case of a communication break.	2
	Speed ref safe	Drive generates warning <i>A7C1 FBA A communication</i> and sets the speed to the value defined by parameter <i>22.41 Speed ref safe</i> (when speed reference is being used) or <i>28.41 Frequency ref safe</i> (when frequency reference is being used). This only occurs if control is expected from the fieldbus.  WARNING! Make sure that it is safe to continue operation in case of a communication break.	3

No.	Name/Value	Description	Def/FbEq16						
	Fault always	Drive trips on fault 7510 FBA A communication . This occurs even though no control is expected from the fieldbus.	4						
	Warning	Drive generates warning A7C1 FBA A communication . This only occurs if control is expected from the fieldbus.  WARNING! Make sure that it is safe to continue operation in case of a communication break.	5						
50.03	FBA A comm loss t out	Defines the time delay before the action defined by parameter 50.02 FBA A comm loss func is taken. Time count starts when the communication link fails to update the message. Note: There is a 60-second boot-up delay immediately after power-up. During the delay, the communication break monitoring is disabled (but communication itself can be active).	0.3 s						
	0.3...6553.5 s	Time delay.	10 = 1 s						
50.04	FBA A ref1 type	Selects the type and scaling of reference 1 received from fieldbus adapter A. The scaling of the reference is defined by parameters 46.01...46.04 , depending on which reference type is selected by this parameter.	Speed or frequency						
	Speed or frequency	Type and scaling is chosen automatically according to the currently active operation mode as follows: <table border="1" data-bbox="347 678 840 782"> <thead> <tr> <th>Operation mode (see par. 19.01)</th> <th>Reference 1 type</th> </tr> </thead> <tbody> <tr> <td>Speed control</td> <td>Speed</td> </tr> <tr> <td>Frequency control</td> <td>Frequency</td> </tr> </tbody> </table>	Operation mode (see par. 19.01)	Reference 1 type	Speed control	Speed	Frequency control	Frequency	0
Operation mode (see par. 19.01)	Reference 1 type								
Speed control	Speed								
Frequency control	Frequency								
	Transparent	No scaling is applied (the 16-bit scaling is 1 = 1 unit). Note: All decimal information is lost, for example, 1.23 = 1.	1						
	General	Generic reference with a 16-bit scaling of 100 = 1 (that is, integer and two decimals). Note: All data after two decimals is lost, for example, 1.234 = 123.	2						
	Speed	The scaling is defined by parameter 46.01 Speed scaling .	4						
	Frequency	The scaling is defined by parameter 46.02 Frequency scaling .	5						
50.05	FBA A ref2 type	Selects the type and scaling of reference 2 received from fieldbus adapter A. The scaling of the reference is defined by parameters 46.01...46.04 , depending on which reference type is selected by this parameter.	Speed or frequency						
	Speed or frequency	Type and scaling is chosen automatically according to the currently active operation mode as follows: <table border="1" data-bbox="347 1189 840 1292"> <thead> <tr> <th>Operation mode (see par. 19.01)</th> <th>Reference 2 type</th> </tr> </thead> <tbody> <tr> <td>Speed control</td> <td>Speed</td> </tr> <tr> <td>Frequency control</td> <td>Frequency</td> </tr> </tbody> </table> Select Speed (selection 4) or Frequency (selection 5) manually.	Operation mode (see par. 19.01)	Reference 2 type	Speed control	Speed	Frequency control	Frequency	0
Operation mode (see par. 19.01)	Reference 2 type								
Speed control	Speed								
Frequency control	Frequency								
	Transparent	No scaling is applied (the 16-bit scaling is 1 = 1 unit). Note: All decimal information is lost, for example, 1.23 = 1.	1						

No.	Name/Value	Description	Def/FbEq16						
	General	Generic reference with a 16-bit scaling of 100 = 1 (that is, integer and two decimals). Note: All data after two decimals is lost, for example, 1.234 = 123.	2						
	Speed	The scaling is defined by parameter 46.01 Speed scaling .	4						
	Frequency	The scaling is defined by parameter 46.02 Frequency scaling .	5						
50.06	FBA A SW sel	Selects the source of the Status word to be sent to the fieldbus network through fieldbus adapter A.	Auto						
	Auto	Source of the Status word is chosen automatically.	0						
	Transparent mode	The source selected by parameter 50.09 FBA A SW transparent source is transmitted as the Status word to the fieldbus network through fieldbus adapter A.	1						
50.07	FBA A actual 1 type	Selects the type and scaling of actual value 1 transmitted to the fieldbus network through fieldbus adapter A. The scaling of the value is defined by parameters 46.01...46.04 , depending on which actual value type is selected by this parameter.	Speed or frequency						
	Speed or frequency	Type and scaling is chosen automatically according to the currently active operation mode as follows: <table border="1" data-bbox="400 675 893 778"> <thead> <tr> <th>Operation mode (see par. 19.01)</th> <th>Actual value 1 type</th> </tr> </thead> <tbody> <tr> <td>Speed control</td> <td>Speed</td> </tr> <tr> <td>Frequency control</td> <td>Frequency</td> </tr> </tbody> </table>	Operation mode (see par. 19.01)	Actual value 1 type	Speed control	Speed	Frequency control	Frequency	0
Operation mode (see par. 19.01)	Actual value 1 type								
Speed control	Speed								
Frequency control	Frequency								
	Transparent	The value selected by parameter 50.10 FBA A act1 transparent source is sent as actual value 1. No scaling is applied (the 16-bit scaling is 1 = 1 unit). Note: All decimal information is lost, for example, 1.23 = 1.	1						
	General	The value selected by parameter 50.10 FBA A act1 transparent source is sent as actual value 1 with a 16-bit scaling of 100 = 1 unit (that is, integer and two decimals). Note: All data after two decimals is lost, for example, 1.234 = 123.	2						
	Speed	01.01 Motor speed used is sent as actual value 1. The scaling is defined by parameter 46.01 Speed scaling .	4						
	Frequency	01.06 Output frequency is sent as actual value 1. The scaling is defined by parameter 46.02 Frequency scaling .	5						

No.	Name/Value	Description	Def/FbEq16						
50.08	<i>FBA A actual 2 type</i>	Selects the type and scaling of actual value 2 transmitted to the fieldbus network through fieldbus adapter A. The scaling of the value is defined by parameters 46.01...46.04 , depending on which actual value type is selected by this parameter.	<i>Speed or frequency</i>						
	Speed or frequency	Type and scaling is chosen automatically according to the currently active operation mode as follows: <table border="1" data-bbox="344 352 837 454"> <thead> <tr> <th>Operation mode (see par. 19.01)</th> <th>Actual value 2 type</th> </tr> </thead> <tbody> <tr> <td>Speed control</td> <td><i>Speed</i></td> </tr> <tr> <td>Frequency control</td> <td><i>Frequency</i></td> </tr> </tbody> </table> Select Speed (selection 4) or Frequency (selection 5) manually.	Operation mode (see par. 19.01)	Actual value 2 type	Speed control	<i>Speed</i>	Frequency control	<i>Frequency</i>	0
Operation mode (see par. 19.01)	Actual value 2 type								
Speed control	<i>Speed</i>								
Frequency control	<i>Frequency</i>								
	Transparent	The value selected by parameter 50.10 FBA A act1 transparent source is sent as actual value 1. No scaling is applied (the 16-bit scaling is 1 = 1 unit). Note: All decimal information is lost, for example, 1.23 = 1.	1						
	General	The value selected by parameter 50.10 FBA A act1 transparent source is sent as actual value 1 with a 16-bit scaling of 100 = 1 unit (that is, integer and two decimals). Note: All data after two decimals is lost, for example, 1.234 = 123.	2						
	Speed	01.01 Motor speed used is sent as actual value 1. The scaling is defined by parameter 46.01 Speed scaling .	4						
	Frequency	01.06 Output frequency is sent as actual value 1. The scaling is defined by parameter 46.02 Frequency scaling .	5						
50.09	<i>FBA A SW transparent source</i>	Selects the source of the fieldbus status word when parameter 50.06 FBA A SW sel is set to <i>Transparent mode</i> .	<i>Not selected</i>						
	Not selected	No source selected.	-						
	<i>Other</i>	Source selection (see Terms and abbreviations on page 285).	-						
50.10	<i>FBA A act1 transparent source</i>	When parameter 50.07 FBA A actual 1 type is set to <i>Transparent</i> , this parameter selects the source of actual value 1 transmitted to the fieldbus network through fieldbus adapter A.	<i>Not selected</i>						
	Not selected	No source selected.	-						
	<i>Other</i>	Source selection (see Terms and abbreviations on page 285).	-						
50.11	<i>FBA A act2 transparent source</i>	When parameter 50.08 FBA A actual 2 type is set to <i>Transparent</i> , this parameter selects the source of actual value 2 transmitted to the fieldbus network through fieldbus adapter A.	<i>Not selected</i>						
	Not selected	No source selected.	-						
	<i>Other</i>	Source selection (see Terms and abbreviations on page 285).	-						
50.12	<i>FBA A debug mode</i>	This parameter enables debug mode. Displays raw (unmodified) data received from and sent to fieldbus adapter A in parameters 50.13...50.18 .	<i>Disable</i>						
	Disable	Debug mode disabled.	0						
	Fast	Debug mode enabled. Cyclical data update is as fast as possible which increases CPU load on the drive.	1						

No.	Name/Value	Description	Def/FbEq16
50.13	<i>FBA A control word</i>	Displays the raw (unmodified) control word sent by the master (PLC) to fieldbus adapter A if debugging is enabled by parameter <i>50.12 FBA A debug mode</i> . This parameter is read-only.	-
	0000000h... FFFFFFFFh	Control word sent by master to fieldbus adapter A.	-
50.14	<i>FBA A reference 1</i>	Displays raw (unmodified) reference REF1 sent by the master (PLC) to fieldbus adapter A if debugging is enabled by parameter <i>50.12 FBA A debug mode</i> . This parameter is read-only.	-
	-2147483648... 2147483647	Raw REF1 sent by master to fieldbus adapter A.	-
50.15	<i>FBA A reference 2</i>	Displays raw (unmodified) reference REF2 sent by the master (PLC) to fieldbus adapter A if debugging is enabled by parameter <i>50.12 FBA A debug mode</i> . This parameter is read-only.	-
	-2147483648... 2147483647	Raw REF2 sent by master to fieldbus adapter A.	-
50.16	<i>FBA A status word</i>	Displays the raw (unmodified) status word sent by fieldbus adapter A to the master (PLC) if debugging is enabled by parameter <i>50.12 FBA A debug mode</i> . This parameter is read-only.	-
	0000000h... FFFFFFFFh	Status word sent by fieldbus adapter A to master.	-
50.17	<i>FBA A actual value 1</i>	Displays raw (unmodified) actual value ACT1 sent by fieldbus adapter A to the master (PLC) if debugging is enabled by parameter <i>50.12 FBA A debug mode</i> . This parameter is read-only.	-
	-2147483648... 2147483647	Raw ACT1 sent by fieldbus adapter A to master.	-
50.18	<i>FBA A actual value 2</i>	Displays raw (unmodified) actual value ACT2 sent by fieldbus adapter A to the master (PLC) if debugging is enabled by parameter <i>50.12 FBA A debug mode</i> . This parameter is read-only.	-
	-2147483648... 2147483647	Raw ACT2 sent by fieldbus adapter A to master.	-
51 FBA A settings		Fieldbus adapter A configuration.	
51.01	<i>FBA A type</i>	Displays the type of the connected fieldbus adapter module. 0 = None. Module is not found or is not properly connected, or is disabled by parameter <i>50.01 FBA A enable</i> . 1 = PROFIBUS-DP 32 = CANopen 37 = DeviceNet 128 = Ethernet 132 = PROFInet IO 135 = EtherCAT 136 = ETH Pwrlink (Ethernet Powerlink) 485 = RS-485 comm 101 = ControlNet 2222 = Ethernet/IP 502 = Modbus/TCP This parameter is read-only.	-

No.	Name/Value	Description	Def/FbEq16
51.02	<i>FBA A Par2</i>	Parameters 51.02...51.26 are adapter module-specific. For more information, see the documentation of the fieldbus adapter module. Note that not all of these parameters are necessarily in use.	0
	0...65535	Fieldbus adapter configuration parameter.	1 = 1

51.26	<i>FBA A Par26</i>	See parameter 51.02 <i>FBA A Par2</i> .	-
	0...65535	Fieldbus adapter configuration parameter.	1 = 1
51.27	<i>FBA A par refresh</i>	Validates any changed fieldbus adapter module configuration settings. After refreshing, the value reverts automatically to <i>Done</i> . Note: This parameter cannot be changed while the drive is running.	<i>Done</i>
	Done	Refreshing done.	0
	Configure	Refreshing.	1
51.28	<i>FBA A par table ver</i>	Displays the parameter table revision of the fieldbus adapter module mapping file (stored in the memory of the drive). In format axyz, where ax = major table revision number; yz = minor table revision number. This parameter is read-only.	-
		Parameter table revision of adapter module.	-
51.29	<i>FBA A drive type code</i>	Displays the drive type code in the fieldbus adapter module mapping file (stored in the memory of the drive). This parameter is read-only.	-
	0...65535	Drive type code stored in the mapping file.	1 = 1
51.30	<i>FBA A mapping file ver</i>	Displays the fieldbus adapter module mapping file revision stored in the memory of the drive in decimal format. This parameter is read-only.	-
	0...65535	Mapping file revision.	1 = 1
51.31	<i>D2FBA A comm status</i>	Displays the status of the fieldbus adapter module communication	<i>Not configured</i>
	Not configured	Adapter is not configured.	0
	Initializing	Adapter is initializing.	1
	Time out	A timeout has occurred in the communication between the adapter and the drive.	2
	Configuration error	Adapter configuration error: mapping file not found in the file system of the drive, or mapping file upload has failed more than three times.	3
	Off-line	Fieldbus communication is off-line.	4
	On-line	Fieldbus communication is on-line, or fieldbus adapter has been configured not to detect a communication break. For more information, see the documentation of the fieldbus adapter.	5
	Reset	Adapter is performing a hardware reset.	6
51.32	<i>FBA A comm SW ver</i>	Displays the common program revision of the adapter module in format axyz, where a = major revision number, xy = minor revision number, z = correction number or letter. Example: 190A = revision 1.90A.	
		Common program revision of adapter module.	-

No.	Name/Value	Description	Def/FbEq16
51.33	<i>FBA A appl SW ver</i>	Displays the application program revision of the adapter module in format axyz, where a = major revision number, xy = minor revision number, z = correction number or letter. Example: 190A = revision 1.90A.	
		Application program version of adapter module.	-

52 FBA A data in		Selection of data to be transferred from drive to fieldbus controller through fieldbus adapter A. Note: 32-bit values require two consecutive parameters. Whenever a 32-bit value is selected in a data parameter, the next parameter is automatically reserved.	
52.01	<i>FBA A data in1</i>	Parameters 52.01...52.12 select data to be transferred from the drive to the fieldbus controller through fieldbus adapter A.	<i>None</i>
	None	None.	0
	CW 16bit	Control Word (16 bits)	1
	Ref1 16bit	Reference REF1 (16 bits)	2
	Ref2 16bit	Reference REF2 (16 bits)	3
	SW 16bit	Status Word (16 bits)	4
	Act1 16bit	Actual value ACT1 (16 bits)	5
	Act2 16bit	Actual value ACT2 (16 bits)	6
	Reserved		7...10
	CW 32bit	Control Word (32 bits)	11
	Ref1 32bit	Reference REF1 (32 bits)	12
	Ref2 32bit	Reference REF2 (32 bits)	13
	SW 32bit	Status Word (32 bits)	14
	Act1 32bit	Actual value ACT1 (32 bits)	15
	Act2 32bit	Actual value ACT2 (32 bits)	16
	Reserved		17...23
	SW2 16bit	Status Word 2 (16 bits)	24
	<i>Other</i>	Source selection (see <i>Terms and abbreviations</i> on page 285).	-

52.12	<i>FBA A data in12</i>	See parameter 52.01 <i>FBA A data in1</i> .	<i>None</i>



53 FBA A data out		Selection of data to be transferred from fieldbus controller to drive through fieldbus adapter A. Note: 32-bit values require two consecutive parameters. Whenever a 32-bit value is selected in a data parameter, the next parameter is automatically reserved.	
53.01	<i>FBA A data out1</i>	Parameters 53.01...53.12 select data to be transferred from the fieldbus controller to the drive through fieldbus adapter A.	<i>None</i>
	None	None.	0
	CW 16bit	Control Word (16 bits)	1
	Ref1 16bit	Reference REF1 (16 bits)	2
	Ref2 16bit	Reference REF2 (16 bits)	3
	Reserved		7...10
	CW 32bit	Control Word (32 bits)	11

No.	Name/Value	Description	Def/FbEq16
	Ref1 32bit	Reference REF1 (32 bits)	12
	Ref2 32bit	Reference REF2 (32 bits)	13
	Reserved		14...20
	CW2 16bit	Control Word 2 (16 bits)	21
	<i>Other</i>	Source selection (see <i>Terms and abbreviations</i> on page 285).	-
...
53.12	<i>FBA A data out12</i>	See parameter <i>53.01 FBA A data out1</i> .	<i>None</i>

58 Embedded fieldbus	Configuration of the embedded fieldbus (EFB) interface. See also chapter <i>Fieldbus control through the embedded fieldbus interface (EFB)</i> (page 223).		
<i>58.01 Protocol enable</i>	Enables/disables the embedded fieldbus interface and selects the protocol to use.	<i>None</i>	
None	None (communication disabled).	0	
Modbus RTU	Embedded fieldbus interface is enabled and uses the Modbus RTU protocol.	1	
Reserved		2...3	
None / IPC communication	Embedded fieldbus interface is enabled and is used for IPC communication.	4	
<i>58.02 Protocol ID</i>	Displays the protocol ID and revision. First 4 bits specify the protocol ID and last 12 bits specify the revision. This parameter is read-only.	-	
	Protocol ID and revision.		
<i>58.03 Node address</i>	Defines the node address of the drive on the fieldbus link. Values 1...247 are allowable. Also called Station ID, MAC Address or Device Address. Two devices with the same address are not allowed on-line. Changes to this parameter take effect after the control unit is rebooted or the new settings validated by parameter <i>58.06 Communication control (Refresh settings)</i> .	1	
0...255	Node address (values 1...247 are allowed).	1 = 1	
<i>58.04 Baud rate</i>	Selects the transfer rate of the fieldbus link. When using selection <i>Autodetect</i> , the parity setting of the bus must be known and configured in parameter <i>58.05 Parity</i> . When parameter <i>58.04 Baud rate</i> is set to <i>Autodetect</i> , the EFB settings must be refreshed with parameter <i>58.06</i> . The bus is monitored for a period of time and the detected baud rate is set as the value of this parameter. Changes to this parameter take effect after the control unit is rebooted or the new settings validated by parameter <i>58.06 Communication control (Refresh settings)</i> .	Modbus RTU: <i>19.2 kbps</i>	
Autodetect	Baud rate detected automatically.	0	
4.8 kbps	4.8 kbit/s.	1	
9.6 kbps	9.6 kbit/s.	2	
19.2 kbps	19.2 kbit/s.	3	
38.4 kbps	38.4 kbit/s.	4	
57.6 kbps	57.6 kbit/s.	5	
76.8 kbps	76.8 kbit/s.	6	

No.	Name/Value	Description	Def/FbEq16																																																			
	115.2 kbps	115.2 kbit/s.	7																																																			
58.05	<i>Parity</i>	<u>Modbus RTU only</u> : Selects the type of parity bit and number of stop bits. Changes to this parameter take effect after the control unit is rebooted or the new settings validated by parameter 58.06 Communication control (Refresh settings) .	8 <i>EVEN 1</i>																																																			
	8 NONE 1	Eight data bits, no parity bit, one stop bit.	0																																																			
	8 NONE 2	Eight data bits, no parity bit, two stop bits.	1																																																			
	8 EVEN 1	Eight data bits, even parity bit, one stop bit.	2																																																			
	8 ODD 1	Eight data bits, odd parity bit, one stop bit.	3																																																			
58.06	<i>Communication control</i>	Takes changed EFB settings in use, or activates silent mode.	<i>Enabled</i>																																																			
	Enabled	Normal operation.	0																																																			
	Refresh settings	Refreshes settings (parameters 58.01...58.05 , 58.14...58.17 , 58.25 , 58.28...58.34) and takes changed EFB configuration settings in use. Reverts automatically to <i>Enabled</i> .	1																																																			
	Silent mode	Activates silent mode (no messages are transmitted). Silent mode can be terminated by activating the <i>Refresh settings</i> selection of this parameter.	2																																																			
58.07	<i>Communication diagnostics</i>	Displays the status of the EFB communication. This parameter is read-only. Note that the name is only visible when the error is present (bit value is 1).	-																																																			
<table border="1"> <thead> <tr> <th>Bit</th> <th>Name</th> <th>Description</th> </tr> </thead> <tbody> <tr> <td>0</td> <td>Init failed</td> <td>1 = EFB initialization failed</td> </tr> <tr> <td>1</td> <td>Addr config err</td> <td>1 = Node address not allowed by protocol</td> </tr> <tr> <td>2</td> <td>Silent mode</td> <td>1 = Drive not allowed to transmit 0 = Drive allowed to transmit</td> </tr> <tr> <td>3</td> <td>Autobauding</td> <td>1 = Automatic detection of baud rate is in use (see parameter 58.04)</td> </tr> <tr> <td>4</td> <td>Wiring error</td> <td>1 = Errors detected (A/B wires possibly swapped)</td> </tr> <tr> <td>5</td> <td>Parity error</td> <td>1 = Error detected: check parameters 58.04 and 58.05</td> </tr> <tr> <td>6</td> <td>Baud rate error</td> <td>1 = Error detected: check parameters 58.05 and 58.04</td> </tr> <tr> <td>7</td> <td>No bus activity</td> <td>1 = 0 bytes received during last 5 seconds</td> </tr> <tr> <td>8</td> <td>No packets</td> <td>1 = 0 packets (addressed to any device) detected during last 5 seconds</td> </tr> <tr> <td>9</td> <td>Noise or addressing error</td> <td>1 = Errors detected (interference, or another device with the same address on line)</td> </tr> <tr> <td>10</td> <td>Comm loss</td> <td>1 = 0 packets addressed to the drive received within timeout (58.16)</td> </tr> <tr> <td>11</td> <td>CW/Ref loss</td> <td>1 = No control word or references received within timeout (58.16)</td> </tr> <tr> <td>12</td> <td>Reserved</td> <td></td> </tr> <tr> <td>13</td> <td>Protocol 1</td> <td>1 = Duplicate ID detected on the network. Used for IPC.</td> </tr> <tr> <td>14</td> <td>Reserved</td> <td></td> </tr> <tr> <td>15</td> <td>Internal error</td> <td>1 = Internal error occurred. Contact your local ABB representative.</td> </tr> </tbody> </table>				Bit	Name	Description	0	Init failed	1 = EFB initialization failed	1	Addr config err	1 = Node address not allowed by protocol	2	Silent mode	1 = Drive not allowed to transmit 0 = Drive allowed to transmit	3	Autobauding	1 = Automatic detection of baud rate is in use (see parameter 58.04)	4	Wiring error	1 = Errors detected (A/B wires possibly swapped)	5	Parity error	1 = Error detected: check parameters 58.04 and 58.05	6	Baud rate error	1 = Error detected: check parameters 58.05 and 58.04	7	No bus activity	1 = 0 bytes received during last 5 seconds	8	No packets	1 = 0 packets (addressed to any device) detected during last 5 seconds	9	Noise or addressing error	1 = Errors detected (interference, or another device with the same address on line)	10	Comm loss	1 = 0 packets addressed to the drive received within timeout (58.16)	11	CW/Ref loss	1 = No control word or references received within timeout (58.16)	12	Reserved		13	Protocol 1	1 = Duplicate ID detected on the network. Used for IPC.	14	Reserved		15	Internal error	1 = Internal error occurred. Contact your local ABB representative.
Bit	Name	Description																																																				
0	Init failed	1 = EFB initialization failed																																																				
1	Addr config err	1 = Node address not allowed by protocol																																																				
2	Silent mode	1 = Drive not allowed to transmit 0 = Drive allowed to transmit																																																				
3	Autobauding	1 = Automatic detection of baud rate is in use (see parameter 58.04)																																																				
4	Wiring error	1 = Errors detected (A/B wires possibly swapped)																																																				
5	Parity error	1 = Error detected: check parameters 58.04 and 58.05																																																				
6	Baud rate error	1 = Error detected: check parameters 58.05 and 58.04																																																				
7	No bus activity	1 = 0 bytes received during last 5 seconds																																																				
8	No packets	1 = 0 packets (addressed to any device) detected during last 5 seconds																																																				
9	Noise or addressing error	1 = Errors detected (interference, or another device with the same address on line)																																																				
10	Comm loss	1 = 0 packets addressed to the drive received within timeout (58.16)																																																				
11	CW/Ref loss	1 = No control word or references received within timeout (58.16)																																																				
12	Reserved																																																					
13	Protocol 1	1 = Duplicate ID detected on the network. Used for IPC.																																																				
14	Reserved																																																					
15	Internal error	1 = Internal error occurred. Contact your local ABB representative.																																																				
	0000h...FFFFh	EFB communication status.	1 = 1																																																			

No.	Name/Value	Description	Def/FbEq16
58.08	<i>Received packets</i>	Displays a count of valid packets addressed to the drive. During normal operation, this number increases constantly. Can be reset from the control panel by pressing the Reset softkey for 3 seconds.	-
	0...4294967295	Number of received packets addressed to the drive.	
58.09	<i>Transmitted packets</i>	Displays a count of valid packets transmitted by the drive. During normal operation, this number increases constantly. Can be reset from the control panel by pressing the Reset softkey for 3 seconds.	-
	0...4294967295	Number of transmitted packets.	
58.10	<i>All packets</i>	Displays a count of valid packets addressed to any device on the bus. During normal operation, this number increases constantly. Can be reset from the control panel by pressing the Reset softkey for 3 seconds.	-
	0...4294967295	Number of all received packets.	
58.11	<i>UART errors</i>	Displays a count of character errors received by the drive. An increasing count indicates a configuration problem on the bus. Can be reset from the control panel by pressing the Reset softkey for 3 seconds.	-
	0...4294967295	Number of UART errors.	
58.12	<i>CRC errors</i>	Displays a count of packets with a CRC error received by the drive. An increasing count indicates interference on the bus. Can be reset from the control panel by pressing the Reset softkey for 3 seconds.	-
	0...4294967295	Number of CRC errors.	
58.14	<i>Communication loss action</i>	Selects how the drive reacts to an EFB communication break. Changes to this parameter take effect after the control unit is rebooted or the new settings validated by parameter 58.06 Communication control (Refresh settings) . See also parameters 58.15 Communication loss mode and 58.16 Communication loss time .	<i>No action</i>
	No action	No action taken (monitoring disabled).	0
	Fault	Drive monitors communication loss when start/stop is expected from the EFB on the currently active control location. The drive trips on fault 6681 EFB comm loss if control in the currently active control location is expected from the EFB or reference is coming from the EFB, and the communication is lost.	1
	Last speed	Drive generates warning A7CE EFB comm loss and freezes the speed to the level the drive was operating at. The speed is determined on the basis of actual speed using 850 ms low-pass filtering. This occurs if control or reference is expected from the EFB.  WARNING! Make sure that it is safe to continue operation in case of a communication break.	2

No.	Name/Value	Description	Def/FbEq16
	Speed ref safe	Drive generates warning <i>A7CE EFB comm loss</i> and sets the speed to the speed defined by parameter <i>22.41 Speed ref safe</i> (or <i>28.41 Frequency ref safe</i> when frequency reference is being used). This occurs if control or reference is expected from the EFB.  WARNING! Make sure that it is safe to continue operation in case of a communication break.	3
	Fault always	Drive continuously monitors for communication loss. Drive trips on fault <i>6681 EFB comm loss</i> . This happens even though the drive is in a control location where the EFB start/stop or reference is not used.	4
	Warning	Drive generates warning <i>A7CE EFB comm loss</i> . This occurs even though no control is expected from the EFB.  WARNING! Make sure that it is safe to continue operation in case of a communication break.	5
<i>58.15</i>	<i>Communication loss mode</i>	Defines which message types reset the timeout counter for detecting an EFB communication loss. Changes to this parameter take effect after the control unit is rebooted or the new settings validated by parameter <i>58.06 Communication control (Refresh settings)</i> . See also parameters <i>58.14 Communication loss action</i> and <i>58.16 Communication loss time</i> .	<i>Cw / Ref1 / Ref2</i>
	Any message	Any message addressed to the drive resets the timeout.	1
	Cw / Ref1 / Ref2	A write of the control word or a reference resets the timeout.	2
<i>58.16</i>	<i>Communication loss time</i>	Sets a timeout for EFB communication. If a communication break lasts longer than the timeout, the action specified by parameter <i>58.14 Communication loss action</i> is taken. Changes to this parameter take effect after the control unit is rebooted or the new settings validated by parameter <i>58.06 Communication control (Refresh settings)</i> . See also parameter <i>58.15 Communication loss mode</i> . Note: There is a 30-second boot-up delay immediately after power-up.	10.0 s
	0.0...6000.0 s	EFB communication timeout.	1 = 1
<i>58.17</i>	<i>Transmit delay</i>	<u>Modbus RTU only</u> : Defines a minimum response delay in addition to any fixed delay imposed by the protocol. Changes to this parameter take effect after the control unit is rebooted or the new settings validated by parameter <i>58.06 Communication control (Refresh settings)</i> .	0 ms
	0...65535 ms	Minimum response delay.	1 = 1
<i>58.18</i>	<i>EFB control word</i>	<u>Modbus RTU only</u> : Displays the raw (unmodified) control word sent by the Modbus controller to the drive. For debugging purposes. This parameter is read-only.	-
	0000000h... FFFFFFFFh	Control word sent by Modbus controller to the drive.	1 = 1
<i>58.19</i>	<i>EFB status word</i>	<u>Modbus RTU only</u> : Displays the raw (unmodified) status word for debugging purposes. This parameter is read-only.	-
	0000000h... FFFFFFFFh	Status word sent by the drive to the Modbus controller.	1 = 1

No.	Name/Value	Description	Def/FbEq16						
58.25	<i>Control profile</i>	Modbus RTU only: Defines the communication profile used by the Modbus protocol. Changes to this parameter take effect after the control unit is rebooted or the new settings validated by parameter 58.06 Communication control (Refresh settings) . See section <i>About the control profiles</i> on page 232 . Note: If you want to use the ABB drives limited profile, set parameter 96.79 Legacy control profile accordingly (supported in firmware revisions 2.15 or later).	<i>ABB Drives</i>						
	ABB Drives	ABB Drives control profile (with a 16-bit control word)	0						
	DCU Profile	DCU control profile (with a 16 or 32-bit control word)	5						
58.26	<i>EFB ref1 type</i>	Modbus RTU only: Selects the type and scaling of reference 1 received through the embedded fieldbus interface. The scaled reference is displayed by 03.09 EFB reference 1 .	<i>Speed or frequency</i>						
	Speed or frequency	Type and scaling is chosen automatically according to the currently active operation mode as follows. <table border="1" data-bbox="348 587 841 691"> <thead> <tr> <th>Operation mode (see par. 19.01)</th> <th>Reference 1 type</th> </tr> </thead> <tbody> <tr> <td>Speed control</td> <td><i>Speed</i></td> </tr> <tr> <td>Frequency control</td> <td><i>Frequency</i></td> </tr> </tbody> </table>	Operation mode (see par. 19.01)	Reference 1 type	Speed control	<i>Speed</i>	Frequency control	<i>Frequency</i>	0
Operation mode (see par. 19.01)	Reference 1 type								
Speed control	<i>Speed</i>								
Frequency control	<i>Frequency</i>								
	Transparent	No scaling is applied.	1						
	General	Generic reference without a specific unit. Scaling: 1 = 100.	2						
	Speed	Speed reference. The scaling is defined by parameter 46.01 Speed scaling .	4						
	Frequency	Frequency reference. The scaling is defined by parameter 46.02 Frequency scaling .	5						
58.27	<i>EFB ref2 type</i>	Modbus RTU only: Selects the type and scaling of reference 2 received through the embedded fieldbus interface. The scaled reference is displayed by 03.10 EFB reference 2 .	<i>Speed or frequency</i>						
58.28	<i>EFB act1 type</i>	Modbus RTU only: Selects the type of actual value 1.	<i>Speed or frequency</i>						
	Speed or frequency	Type and scaling is chosen automatically according to the currently active operation mode as follows. <table border="1" data-bbox="348 1098 841 1201"> <thead> <tr> <th>Operation mode (see par. 19.01)</th> <th>Actual 1 type</th> </tr> </thead> <tbody> <tr> <td>Speed control</td> <td><i>Speed</i></td> </tr> <tr> <td>Frequency control</td> <td><i>Frequency</i></td> </tr> </tbody> </table>	Operation mode (see par. 19.01)	Actual 1 type	Speed control	<i>Speed</i>	Frequency control	<i>Frequency</i>	0
Operation mode (see par. 19.01)	Actual 1 type								
Speed control	<i>Speed</i>								
Frequency control	<i>Frequency</i>								
	Transparent	No scaling is applied.	1						
	General	Generic reference without a specific unit. Scaling: 1 = 100.	2						
	Speed	Scaling is defined by parameter 46.01 Speed scaling .	4						
	Frequency	Scaling is defined by parameter 46.02 Frequency scaling .	5						
58.29	<i>EFB act2 type</i>	Modbus RTU only: Selects the type of actual value 2. For the selections, see parameter 58.28 EFB act1 type .	<i>Transparent</i>						

No.	Name/Value	Description	Def/FbEq16
58.31	<i>EFB act1 transparent source</i>	<u>Modbus RTU only</u> : Selects the source of actual value 1 when parameter <i>58.28 EFB act1 type</i> is set to <i>Transparent</i> .	<i>Not selected</i>
	Not selected	None.	0
	<i>Other</i>	Source selection (see <i>Terms and abbreviations</i> on page 285).	-
58.32	<i>EFB act2 transparent source</i>	<u>Modbus RTU only</u> : Selects the source of actual value 2 when parameter <i>58.29 EFB act2 type</i> is set to <i>Transparent</i> .	<i>Not selected</i>
	Not selected	None.	0
	<i>Other</i>	Source selection (see <i>Terms and abbreviations</i> on page 285).	-
58.33	<i>Addressing mode</i>	<u>Modbus RTU only</u> : Defines the mapping between parameters and holding registers in the 400101...465535 Modbus register range. Changes to this parameter take effect after the control unit is rebooted or the new settings validated by parameter <i>58.06 Communication control (Refresh settings)</i> .	<i>Mode 0</i>
	Mode 0	<u>16-bit values (groups 1...99, indexes 1...99)</u> : Register address = 400000 + 100 × parameter group + parameter index. For example, parameter 22.80 would be mapped to register 400000 + 2200 + 80 = 402280. <u>32-bit values (groups 1...99, indexes 1...99)</u> : Register address = 420000 + 200 × parameter group + 2 × parameter index. For example, parameter 22.80 would be mapped to register 420000 + 4400 + 160 = 424560.	0
	Mode 1	<u>16-bit values (groups 1...255, indexes 1...255)</u> : Register address = 400000 + 256 × parameter group + parameter index. For example, parameter 22.80 would be mapped to register 400000 + 5632 + 80 = 405712.	1
	Mode 2	<u>32-bit values (groups 1...127, indexes 1...255)</u> : Register address = 400000 + 512 × parameter group + 2 × parameter index. For example, parameter 22.80 would be mapped to register 400000 + 11264 + 160 = 411424.	2
58.34	<i>Word order</i>	<u>Modbus RTU only</u> : Selects in which order 16-bit registers of 32-bit parameters are transferred. For each register, the first byte contains the high order byte and the second byte contains the low order byte. Changes to this parameter take effect after the control unit is rebooted or the new settings validated by parameter <i>58.06 Communication control (Refresh settings)</i> .	<i>LO-HI</i>
	HI-LO	The first register contains the high order word, the second contains the low order word.	0
	LO-HI	The first register contains the low order word, the second contains the high order word.	1
58.101	<i>Data I/O 1</i>	<u>Modbus RTU only</u> : Defines the address in the drive which the Modbus master accesses when it reads from or writes to the register address corresponding to Modbus register 1 (400001). The master defines the type of the data (input or output). The value is transmitted in a Modbus frame consisting of two 16-bit words. If the value is 16-bit, it is transmitted in the LSW (least significant word). If the value is 32-bit, the subsequent parameter is also reserved for it and must be set to <i>None</i> .	<i>CW 16bit</i>
	None	No mapping, register is always zero.	0
	CW 16bit	<i>ABB Drives</i> profile: 16-bit ABB drives control word; <i>DCU Profile</i> : lower 16 bits of the DCU control word.	1

No.	Name/Value	Description	Def/FbEq16
	Ref1 16bit	Reference REF1 (16 bits).	2
	Ref2 16bit	Reference REF2 (16 bits).	3
	SW 16bit	<i>ABB Drives</i> profile: 16-bit ABB drives status word; <i>DCU Profile</i> : lower 16 bits of the DCU status word.	4
	Act1 16bit	Actual value ACT1 (16 bits).	5
	Act2 16bit	Actual value ACT2 aha(16 bits).	6
	Reserved		7...10
	CW 32bit	Control Word (32 bits).	11
	Ref1 32bit	Reference REF1 (32 bits).	12
	Ref2 32bit	Reference REF2 (32 bits).	13
	SW 32bit	Status Word (32 bits).	14
	Act1 32bit	Actual value ACT1 (32 bits).	15
	Act2 32bit	Actual value ACT2 (32 bits).	16
	Reserved		17...20
	CW2 16bit	<i>ABB Drives</i> profile: not used; <i>DCU Profile</i> : upper 16 bits of the DCU control word.	21
	SW2 16bit	<i>ABB Drives</i> profile: not used / always zero; <i>DCU Profile</i> : upper 16 bits of the DCU status word.	24
	Reserved		25...30
	RO/DIO control word	Parameter <i>10.99 RO/DIO control word</i> .	31
	AO1 data storage	Parameter <i>13.91 AO1 data storage</i> .	32
	AO2 data storage	Parameter <i>13.92 AO2 data storage</i> .	33
	Reserved		34...39
	Feedback data storage	Parameter <i>40.91 Feedback data storage</i> .	40
	Setpoint data storage	Parameter <i>40.92 Setpoint data storage</i> .	41
	<i>Other</i>	Source selection (see <i>Terms and abbreviations</i> on page 285).	-
<i>58.102</i>	<i>Data I/O 2</i>	<u>Modbus RTU only</u> ; Defines the address in the drive which the Modbus master accesses when it reads from or writes to register address 400002. For the selections, see parameter <i>58.101 Data I/O 1</i> .	<i>Ref1 16bit</i>
<i>58.103</i>	<i>Data I/O 3</i>	<u>Modbus RTU only</u> ; Defines the address in the drive which the Modbus master accesses when it reads from or writes to register address 400003. For the selections, see parameter <i>58.101 Data I/O 1</i> .	<i>Ref2 16bit</i>
<i>58.104</i>	<i>Data I/O 4</i>	<u>Modbus RTU only</u> ; Defines the address in the drive which the Modbus master accesses when it reads from or writes to register address 400004. For the selections, see parameter <i>58.101 Data I/O 1</i> .	<i>SW 16bit</i>
<i>58.105</i>	<i>Data I/O 5</i>	<u>Modbus RTU only</u> ; Defines the address in the drive which the Modbus master accesses when it reads from or writes to register address 400005. For the selections, see parameter <i>58.101 Data I/O 1</i> .	<i>Act1 16bit</i>

No.	Name/Value	Description	Def/FbEq16
58.106	Data I/O 6	<u>Modbus RTU only</u> : Defines the address in the drive which the Modbus master accesses when it reads from or writes to register address 400006. For the selections, see parameter 58.101 Data I/O 1 .	Act2 16bit
58.107	Data I/O 7	<u>Modbus RTU only</u> : Parameter selector for Modbus register address 400007. For the selections, see parameter 58.101 Data I/O 1 .	None
...
58.114	Data I/O 14	<u>Modbus RTU only</u> : Parameter selector for Modbus register address 400014. For the selections, see parameter 58.101 Data I/O 1 .	None

60 DDCS communication		DCS communication configuration. (Only visible for ACQ580-31 and ACQ580-34). The DDCS protocol is used in the communication between the drive (or more precisely, an inverter unit) and the supply unit of the drive system. See section Control of a line supply unit (LSU) (page 97). The communication utilizes the internal communication channel between the inverter unit (INU) and the supply unit (LSU).	
60.78	INU-LSU comm loss timeout	Sets a timeout for communication with another converter (such as the supply unit). If a communication break lasts longer than the timeout, the action specified by parameter 60.79 INU-LSU comm loss function is taken.	100 ms
	0...65535 ms	Timeout for communication between converters.	1 = 1 ms
60.79	INU-LSU comm loss function	Selects how the inverter unit reacts to a communication break between the inverter unit and the other converter (typically the supply unit).  WARNING! With settings other than <i>Fault</i> , the inverter unit will continue operating based on the status information that was last received from the other converter. Make sure this does not cause danger.	Fault
	No action	No action taken.	0
	Warning	Drive generates warning AF80 INU-LSU comm loss .	1
	Fault	Drive trips on fault 7580 INU-LSU comm loss .	2

61 D2D and DDCS transmit data		Defines the data sent to the DDCS link. (Only visible for ACQ580-31 and ACQ580-34). See also parameter group 60 DDCS communication .	
61.201	INU-LSU data set 10 data 1 value	Displays (in integer format) the data to be sent to the other converter as word 1 of data set 10.	0
	0...65535	Data to be sent as word 1 of data set 10.	1 = 1
61.202	INU-LSU data set 10 data 2 value	Displays (in integer format) the data to be sent to the other converter as word 2 of data set 10.	0
	0...65535	Data to be sent as word 2 of data set 10.	1 = 1
61.203	INU-LSU data set 10 data 3 value	Displays (in integer format) the data to be sent to the other converter as word 3 of data set 10.	0
	0...65535	Data to be sent as word 3 of data set 10.	1 = 1

No.	Name/Value	Description	Def/FbEq16																																	
62 D2D and DDCS receive data																																				
		Defines the data sent to the DDCS link. (Only visible for ACQ580-31 and ACQ580-34). See also parameter group 60 DDCS communication .																																		
62.201	<i>INU-LSU data set 11 data 1 value</i>	Displays (in integer format) the data to be sent to the other converter as word 1 of data set 10.	0																																	
0...65535		Data to be sent as word 1 of data set 10.	1 = 1																																	
71 External PID1																																				
		Configuration of external PID. See control chain diagrams <i>External PID setpoint and feedback source selection</i> , and <i>External PID controller</i> on pages 280 and 281, respectively.																																		
71.01	<i>External PID act value</i>	See parameter 40.01 Process PID output actual .	-																																	
71.02	<i>Feedback act value</i>	See parameter 40.02 Process PID feedback actual .	-																																	
71.03	<i>Setpoint act value</i>	See parameter 40.03 Process PID setpoint actual .	-																																	
71.04	<i>Deviation act value</i>	See parameter 40.04 Process PID deviation actual .	-																																	
71.06	<i>PID status word</i>	Displays status information on process external PID control. This parameter is read-only.	-																																	
<table border="1"> <thead> <tr> <th>Bit</th> <th>Name</th> <th>Value</th> </tr> </thead> <tbody> <tr> <td>0</td> <td>PID active</td> <td>1 = Process PID control active.</td> </tr> <tr> <td>1</td> <td colspan="2">Reserved</td> </tr> <tr> <td>2</td> <td>Output frozen</td> <td>1 = Process PID controller output frozen. Bit is set if parameter 71.38 Output freeze enable is TRUE, or the deadband function is active (bit 9 is set).</td> </tr> <tr> <td>3...6</td> <td colspan="2">Reserved</td> </tr> <tr> <td>7</td> <td>Output limit high</td> <td>1 = PID output is being limited by par. 71.37.</td> </tr> <tr> <td>8</td> <td>Output limit low</td> <td>1 = PID output is being limited by par. 71.36.</td> </tr> <tr> <td>9</td> <td>Deadband active</td> <td>1 = Deadband is active.</td> </tr> <tr> <td>10...11</td> <td colspan="2">Reserved</td> </tr> <tr> <td>12</td> <td>Internal setpoint active</td> <td>1 = Internal setpoint active (see par. 71.16...71.23)</td> </tr> <tr> <td>13...15</td> <td colspan="2">Reserved</td> </tr> </tbody> </table>				Bit	Name	Value	0	PID active	1 = Process PID control active.	1	Reserved		2	Output frozen	1 = Process PID controller output frozen. Bit is set if parameter 71.38 Output freeze enable is TRUE, or the deadband function is active (bit 9 is set).	3...6	Reserved		7	Output limit high	1 = PID output is being limited by par. 71.37 .	8	Output limit low	1 = PID output is being limited by par. 71.36 .	9	Deadband active	1 = Deadband is active.	10...11	Reserved		12	Internal setpoint active	1 = Internal setpoint active (see par. 71.16...71.23)	13...15	Reserved	
Bit	Name	Value																																		
0	PID active	1 = Process PID control active.																																		
1	Reserved																																			
2	Output frozen	1 = Process PID controller output frozen. Bit is set if parameter 71.38 Output freeze enable is TRUE, or the deadband function is active (bit 9 is set).																																		
3...6	Reserved																																			
7	Output limit high	1 = PID output is being limited by par. 71.37 .																																		
8	Output limit low	1 = PID output is being limited by par. 71.36 .																																		
9	Deadband active	1 = Deadband is active.																																		
10...11	Reserved																																			
12	Internal setpoint active	1 = Internal setpoint active (see par. 71.16...71.23)																																		
13...15	Reserved																																			
0000h...FFFFh		Process PID control status word.	1 = 1																																	
71.07	<i>PID operation mode</i>	See parameter 40.07 Process PID operation mode .	Off																																	
71.08	<i>Feedback 1 source</i>	See parameter 40.08 Set 1 feedback 1 source .	Not selected																																	
71.11	<i>Feedback filter time</i>	See parameter 40.11 Set 1 feedback filter time .	0.000 s																																	

No.	Name/Value	Description	Def/FbEq16
71.14	Setpoint scaling	Defines, together with parameter 71.15 Output scaling , a general scaling factor for the external PID control chain. The scaling can be utilized when, for example, the process setpoint is input in Hz, and the output of the PID controller is used as an rpm value in speed control. In this case, this parameter might be set to 50, and parameter 71.15 to the nominal motor speed at 50 Hz. In effect, the output of the PID controller [71.15] when deviation (setpoint - feedback) = [71.14] and [71.32] = 1. Note: The scaling is based on the ratio between 71.14 and 71.15 . For example, the values 50 and 1500 would produce the same scaling as 1 and 3.	1500.00
	-200000.00... 200000.0	Process setpoint base.	1 = 1
71.15	Output scaling	See parameter 71.14 Setpoint scaling .	1500.00
	-200000.00... 200000.0	Process PID controller output base.	1 = 1
71.16	Setpoint 1 source	See parameter 40.16 Set 1 setpoint 1 source .	<i>Not selected</i>
71.19	Internal setpoint sel1	See parameter 40.19 Set 1 internal setpoint sel1 .	<i>Not selected</i>
71.20	Internal setpoint sel2	See parameter 40.20 Set 1 internal setpoint sel2 .	<i>Not selected</i>
71.21	Internal setpoint 1	See parameter 40.21 Set 1 internal setpoint 1 .	0.00%
71.22	Internal setpoint 2	See parameter 40.22 Set 1 internal setpoint 2 .	0.00%
71.23	Internal setpoint 3	See parameter 40.23 Set 1 internal setpoint 3 .	0.00%
71.26	Setpoint min	See parameter 40.26 Set 1 setpoint min .	0.00%
71.27	Setpoint max	See parameter 40.27 Set 1 setpoint max .	200000.00%
71.31	Deviation inversion	See parameter 40.31 Set 1 deviation inversion .	<i>Not inverted (Ref - Fbk)</i>
71.32	Gain	See parameter 40.32 Set 1 gain .	1.00
71.33	Integration time	See parameter 40.33 Set 1 integration time .	60.0 s
71.34	Derivation time	See parameter 40.34 Set 1 derivation time .	0.000 s
71.35	Derivation filter time	See parameter 40.35 Set 1 derivation filter time .	0.0 s
71.36	Output min	See parameter 40.36 Set 1 output min .	-200000.00%
71.37	Output max	See parameter 40.37 Set 1 output max .	200000.00%
71.38	Output freeze enable	See parameter 40.38 Set 1 output freeze enable .	<i>Not selected</i>
71.39	Deadband range	The control program compares the absolute value of parameter 71.04 Deviation act value to the deadband range defined by this parameter. If the absolute value is within the deadband range for the time period defined by parameter 71.40 Deadband delay , PID's deadband mode is activated and 71.06 PID status word bit 9 Deadband active is set. Then PID's output is frozen and 71.06 PID status word bit 2 Output frozen is set. If the absolute value is equal or greater than the deadband range, PID's deadband mode is deactivated.	0.0%
	0.0...200000.0	Range	1 = 1

No.	Name/Value	Description	Def/FbEq16
71.40	<i>Deadband delay</i>	Defines the deadband delay for the deadband function. See parameter 71.39 Deadband range .	0.0 s
	0.0...3600.0 s	Delay	1 = 1 s
71.58	<i>Increase prevention</i>	See parameter 40.58 Set 1 increase prevention .	No
71.59	<i>Decrease prevention</i>	See parameter 40.59 Set 1 decrease prevention .	No
71.62	<i>Internal setpoint actual</i>	See parameter 40.62 PID internal setpoint actual .	0.00%
71.79	<i>External PID units</i>	See parameter 40.79 Set 1 units .	%

76 Multipump configuration		PFC (Pump and fan control), multipump and autochange configuration parameters. See sections Single pump control (PFC/SPFC) on page 112 and Intelligent pump control (IPC) on page 99. Note: Parameters are dynamically hidden based on selection of pumping mode (76.21 Multipump configuration) and number of motors (76.25 Number of motors).	
76.01	<i>PFC status</i>	Displays the running/stopped status of the PFC motors. PFC1, PFC2, PFC3, PFC4, PFC5 and PFC6 always correspond to the 1st...6th motor of the PFC system. If 76.74 Autochange auxiliary PFC auxiliary PFC is set to <i>Aux motors only</i> , PFC1 represents the motor connected to the drive and PFC2 the first auxiliary motor (the 2nd motor of the system). If 76.74 is set to <i>All motors</i> , PFC1 is the first motor, PFC2 the 2nd. The drive can be connected to any of these motors depending on the Autochange functionality.	-

Bit	Name	Value
0	PFC 1 running	0 = Stop, 1 = Start
1	PFC 2 running	0 = Stop, 1 = Start
2	PFC 3 running	0 = Stop, 1 = Start
3	PFC 4 running	0 = Stop, 1 = Start
4	PFC 5 running	0 = Stop, 1 = Start
5	PFC 6 running	0 = Stop, 1 = Start
6...15	Reserved	

0000h...FFFFh	Status of the PFC relay outputs.	1 = 1	
76.02	<i>Multipump system status</i>	Displays the status of the multipump system in text format. Provides a quick PFC or IPC system overview, for example, if the parameter is added to the Home view on the control panel.	<i>PFC disabled</i>
	PFC disabled	PFC (Pump control) is disabled.	0
	PFC enabled (not started)	PFC is enabled but not started.	1
	SPFC enabled (not started)	SPFC (Soft pump control) is enabled but not started.	2
	MPFC enabled	Reserved.	3
	Running with VSD	The drive is controlling one pump motor, no auxiliary motors are used.	100

No.	Name/Value	Description	Def/FbEq16
	Running with VSD + 1 Aux	One auxiliary motor has been taken in use.	101
	Running with VSD + 2 Aux	Two auxiliary motor have been taken in use.	102
	Running with VSD + 3 Aux	Three auxiliary motor have been taken in use.	103
	Starting Aux1	Auxiliary motor 1 is being started.	200
	Starting Aux2	Auxiliary motor 2 is being started.	201
	Starting Aux3	Auxiliary motor 3 is being started.	202
	Stopping Aux1	Auxiliary motor 1 is being stopped.	300
	Stopping Aux2	Auxiliary motor 2 is being stopped.	301
	Stopping Aux3	Auxiliary motor 3 is being stopped.	302
	Autochange active	Autochange, that is, automatic rotation of the start order is active.	400
	No auxiliary motors available to be started	No auxiliary motors are available to be started, for example, all are already running, or a motor is not available due to maintenance.	500
	Regulator bypass active	Direct-on-line pumps are automatically started and stopped.	600
	MPFC connection ok	Reserved.	700
	PID sleep	PID sleep is in use, and the pump can be stopped in during low demand.	800
	PID sleep boost	PID sleep with extended sleep time is in use, and the pump can be stopped in during low demand.	801
	Invalid configuration	PFC configuration is invalid.	4
	PFC inactive (local control)	PFC is inactive because the drive is in local control.	5
	PFC inactive (invalid operation mode)	PFC is inactive because of an invalid operation mode.	6
	Drive motor interlocked	The motor connected to the drive is interlocked (not available). Warning <i>D503 VSD controlled PFC motor interlocked</i> (page 201) is generated.	7
	All motors interlocked	All motors are interlocked (not available). Warning <i>D502 All motors interlocked</i> (page 201) is generated.	8
	PFC inactive (ext1 active)	PFC is inactive because external control location EXT1 is in use. PFC is supported in EXT2 only.	9
	Interlocked	Pump is interlocked.	701
	Not ready	IPC is not ready.	702
	Standby	Drive is in standby mode.	703
	Master	Drive is master, running.	704
	Master (limited)	Drive is master, one or more pumps are offline or inhibited.	705
	Follower	Drive is follower.	706
	Follower (limited)	Drive is follower, one or more pumps are offline or inhibited.	707
	Follower (starting)	Drive is follower, starting.	708

No.	Name/Value	Description	Def/FbEq16
	Master (stop delay)	Drive is master, waiting until stop delay time has passed.	709
	Master (start delay)	Drive is master, waiting until start delay time has passed.	710
	Master (wait start ack)	Waiting for master pump.	711
	Master (starting follower)	Drive is master, follower is starting.	712
	Master (wait switch ack)	Waiting for master pump.	713
	Master (stopping follower)	Drive is master, follower is stopping.	714
	Master (offline)	Drive is master, offline.	715
	Not ready (node error)	Duplicate node(s) with same ID detected.	716
	Follower (stopping)	Pump is a follower and stopping	717
	Not ready (Off mode)	Drive is in Off mode.	718
	Not ready (Hand mode)	Drive is in Hand mode.	719
	Not ready (Hand mode (EXT1))	EXT1 selected as external control source.	720
	Standby (offline)	Drive is in standby mode, no remote pumps are connected	721
	Master (autochange)	Drive is master, master is changing.	722
	Master (PID sleep)	Drive is master, PID is sleeping.	723
	IPC version error	FW versions are not compatible between drives.	724
	Synchronizing settings	Synchronizing settings.	725
	Master (sleep)	Level control, No pumps are running, pump is the next master.	726
	Not ready	No nodes defined.	727
	Master (decaking)	Drive is master, decaking.	728
	Not ready (pumping mode)	Node settings mismatch.	729
	Not ready (level conflict)	Conflict in pump start or stop levels. One possible reason for this can be if parameter 30.13 Minimum frequency is higher than parameter 76.41 Stop point 1 .	730
76.05	Measured level	Displays the measured level. This parameter is active when parameter 76.21 Multipump configuration is set to Level control - Emptying or Level control - Filling .	-
	0.00...32767.00 m	Measured level in meters.	1 = 1 m
76.06	Measured level %	Displays the measured level as a percentage of level control operation area. The signal is scaled to stop level 1 and full speed level.	-
	0...100%	Measured level in %.	1 = 1%
76.07	LC speed ref	Displays the level control speed reference.	-

No.	Name/Value	Description	Def/FbEq16																																													
	-2147483648... 2147483520 Hz	Level control speed reference.	1 = 1 Hz																																													
76.11	Pump status 1	Shows the status of pump 1.	-																																													
		<table border="1"> <thead> <tr> <th>Bit</th> <th>Name</th> <th>Value</th> </tr> </thead> <tbody> <tr> <td>0</td> <td>Ready</td> <td>0 = False, 1 = True</td> </tr> <tr> <td>1</td> <td>CRC mismatch</td> <td>0 = False, 1 = True</td> </tr> <tr> <td>2</td> <td>Running</td> <td>0 = False, 1 = True</td> </tr> <tr> <td>3...4</td> <td>Reserved</td> <td></td> </tr> <tr> <td>5</td> <td>In PFC control</td> <td>0 = False, 1 = True</td> </tr> <tr> <td>6</td> <td>In IPC control</td> <td>0 = False, 1 = True</td> </tr> <tr> <td>7</td> <td>Master enable</td> <td>0 = False, 1 = True</td> </tr> <tr> <td>8</td> <td>Active master</td> <td>0 = False, 1 = True</td> </tr> <tr> <td>9...10</td> <td>Reserved</td> <td></td> </tr> <tr> <td>11</td> <td>Interlocked</td> <td>0 = False, 1 = True</td> </tr> <tr> <td>12</td> <td>Local mode</td> <td>0 = False, 1 = True</td> </tr> <tr> <td>13</td> <td>Reserved</td> <td></td> </tr> <tr> <td>14</td> <td>Drive start active</td> <td>0 = False, 1 = True</td> </tr> <tr> <td>15</td> <td>Max stationary time elapsed</td> <td>0 = False, 1 = True</td> </tr> </tbody> </table>	Bit	Name	Value	0	Ready	0 = False, 1 = True	1	CRC mismatch	0 = False, 1 = True	2	Running	0 = False, 1 = True	3...4	Reserved		5	In PFC control	0 = False, 1 = True	6	In IPC control	0 = False, 1 = True	7	Master enable	0 = False, 1 = True	8	Active master	0 = False, 1 = True	9...10	Reserved		11	Interlocked	0 = False, 1 = True	12	Local mode	0 = False, 1 = True	13	Reserved		14	Drive start active	0 = False, 1 = True	15	Max stationary time elapsed	0 = False, 1 = True	
Bit	Name	Value																																														
0	Ready	0 = False, 1 = True																																														
1	CRC mismatch	0 = False, 1 = True																																														
2	Running	0 = False, 1 = True																																														
3...4	Reserved																																															
5	In PFC control	0 = False, 1 = True																																														
6	In IPC control	0 = False, 1 = True																																														
7	Master enable	0 = False, 1 = True																																														
8	Active master	0 = False, 1 = True																																														
9...10	Reserved																																															
11	Interlocked	0 = False, 1 = True																																														
12	Local mode	0 = False, 1 = True																																														
13	Reserved																																															
14	Drive start active	0 = False, 1 = True																																														
15	Max stationary time elapsed	0 = False, 1 = True																																														
	0000h...FFFFh	Status of pump 1.	1 = 1																																													
76.12	Pump status 2	See parameter 76.11 Pump status 1 .	-																																													
76.13	Pump status 3	See parameter 76.11 Pump status 1 .	-																																													
76.14	Pump status 4	See parameter 76.11 Pump status 1 .	-																																													
76.15	Pump status 5	See parameter 76.11 Pump status 1 .	-																																													
76.16	Pump status 6	See parameter 76.11 Pump status 1 .	-																																													
76.17	Pump status 7	See parameter 76.11 Pump status 1 . Only for IPC.	-																																													
76.18	Pump status 8	See parameter 76.11 Pump status 1 . Only for IPC.	-																																													
76.21	Multipump configuration	Selects the multi-pump mode.	<i>Off</i>																																													
	Off	Disabled.	0																																													
	IPC	IPC enabled. See Intelligent pump control (IPC) on page 99.	1																																													
	PFC	PFC enabled. One pump at a time is controlled by the drive. The remaining pumps are direct-on-line pumps that are started and stopped by the drive logic. The frequency (group 28 Frequency reference chain) / speed (group 22 Speed reference selection) reference must be defined as PID for the PFC functionality to work properly. See Single pump control (PFC/SPFC) on page 112.	2																																													
	SPFC	SPFC enabled. See section Soft pump control (SPFC) on page 113.	3																																													
	Level control - Emptying	Level control - Emptying is enabled. See section Level control on page 119.	4																																													

No.	Name/Value	Description	Def/FbEq16
	Level control - Filling	Level control - Filling is enabled. See section Level control on page 119.	5
76.22	<i>Multipump node number</i>	Node number of the drive on inverter-to-inverter link. Note: <ul style="list-style-type: none"> Each drive on the link has a unique node number. Node numbers of the drives must be sequential starting from 1, so that if there are, for example, four nodes, they must be 1, 2, 3 and 4. If the drive is not given a priority class, the node number is also used in determining the starting order of the pumps. 	0
	0	No communication.	
	1...8	IPC node number.	
76.23	<i>Master enable</i>	Selects if this pump operate as a master drive of the IPC system. The master drive must have sensor connection in order to control the process.	<i>Enabled</i>
	Disabled	The drive can only be a follower on a inverter-to-inverter link.	0
	Enabled	The drive can be a master on a inverter-to-inverter link.	1
	<i>Other [bit]</i>	Source selection (see Terms and abbreviations on page 285). Allows connection to any bit source. For example AI supervision can be connected via parameter 04.40 by selecting an appropriate warning to any available bit.	
76.24	<i>IPC communication port</i>	Multipump feature can be used over embedded fieldbus interface, or fieldbus adapter interface with FMBA-01 adapter. Using FMBA-01 adapter allows embedded fieldbus to be used for other purposes. If parameters have been incorrectly defined, the drive generates warning A6E7 IPC configuration warning .	<i>EFB</i>
	EFB	Embedded fieldbus interface is used for IPC communication. Set parameter 76.21 Multipump configuration to value <i>IPC</i> , <i>Level control - Emptying</i> or <i>Level control - Filling</i> and parameter 58.01 Protocol enable to value <i>None / IPC communication</i> .	0
	FBA	Fieldbus adapter interface with FBMA-01 adapter is used for IPC communication. Connect FBMA-01 adapter to slot 1. Set parameter 50.01 FBA A enable to value <i>Disable</i> .	1
76.25	<i>Number of motors</i>	Total number of motors used in the application, including the motor connected directly to the drive.	1
	1...8	Number of motors. For PFC 1...6, for IPC 1...8.	1 = 1
76.26	<i>Min number of motors allowed</i>	Minimum number of motors running simultaneously.	1
	0...8	Minimum number of motors. When using the Intelligent Pump Control (IPC) functionality, the minimum value is 1. For PFC 0...6, for IPC 1...8.	1 = 1
76.27	<i>Max number of motors allowed</i>	Maximum number of motors running simultaneously.	1
	1...8	Maximum number of motors. For PFC 1...6, for IPC 1...8.	1 = 1

No.	Name/Value	Description	Def/FbEq16
76.30	<i>Start point 1</i>	<p>Defines the start speed, frequency or point (Hz/rpm/m) for the first auxiliary motor. As the motor speed or frequency exceeds the limit defined by this parameter, a new auxiliary motor is started.</p> <p>To avoid nuisance starts of the second auxiliary motor, the speed of the variable speed motor should be higher than the start speed for the duration defined by parameter <i>76.55 Start delay</i>. If the speed decreases below the start speed, the auxiliary motor is not started.</p> <p>To maintain the process conditions during the start of the second auxiliary motor, a speed hold on time can be defined with parameter <i>76.57 PFC speed hold on</i>. Certain pump types do not produce significant flow with low frequencies. The speed hold on time can be used to compensate the time needed to accelerate the second auxiliary motor to a speed where it produces flow. The start of the second auxiliary motor is not aborted if the speed of the first auxiliary motor decreases</p>	Vector: 1300 rpm; Scalar 48 Hz; 58 Hz (95.20 b0) Level control: 24.00 m
0.00...32767.00 rpm/Hz/m	Speed/frequency/level	1 = 1 unit	
76.31	<i>Start point 2</i>	Defines the start speed, frequency or point (Hz/rpm/m) for the second auxiliary motor. See parameter <i>76.31 Start point 1</i> .	Vector: 1300 rpm; Scalar 48 Hz; 58 Hz (95.20 b0) Level control: 30.00 m
76.32	<i>Start point 3</i>	Defines the start speed, frequency or point (Hz/rpm/m) for the third auxiliary motor. See parameter <i>76.31 Start point 1</i> .	Vector: 1300 rpm; Scalar 48 Hz; 58 Hz (95.20 b0) Level control: 36.00 m

No.	Name/Value	Description	Def/FbEq16
76.33	<i>Start point 4</i>	Defines the start speed, frequency or point (Hz/rpm/m) for the fourth follower pump/auxiliary motor. See parameter 76.30 Start point 1 .	Vector: 1300 rpm; Scalar 48 Hz; 58 Hz (95.20 b0) Level control: 39.00 m
76.34	<i>Start point 5</i>	Defines the start speed, frequency or point (Hz/rpm/m) for the fifth follower pump/auxiliary motor. See parameter 76.30 Start point 1 .	Vector: 1300 rpm; Scalar 48 Hz; 58 Hz (95.20 b0) Level control: 42.00 m
76.35	<i>Start point 6</i>	Defines the start speed, frequency or point (Hz/rpm/m) for the sixth follower pump/auxiliary motor. See parameter 76.30 Start point 1 . For IPC only.	Vector: 1300 rpm; Scalar 48 Hz; 58 Hz (95.20 b0) Level control: 45.00 m
76.36	<i>Start point 7</i>	Defines the start speed, frequency or point (Hz/rpm/m) for the seventh follower pump/auxiliary motor. See parameter 76.30 Start point 1 . For IPC only.	Vector: 1300 rpm; Scalar 48 Hz; 58 Hz (95.20 b0) Level control: 48.00 m
76.37	<i>Start point 8</i>	Defines the start point for the eighth follower pump/auxiliary motor. See parameter 76.30 Start point 1 . Note: This parameter is active only in the Level control only.	Level control: 51.00 m
76.41	<i>Stop point 1</i>	Defines the stop speed, frequency or point (Hz/rpm/m) for the first auxiliary motor. When the speed or frequency of the motor connected directly to the drive falls below this value and one auxiliary motor is running, the stop delay defined by parameter 76.56 Stop delay is started. If the speed is still at the same level or lower when the stop delay elapses, the first auxiliary motor stops. The running speed of the drive is increased by [Start point 1 - Stop point 1] after the auxiliary motor stops.	Vector: 800 rpm; Scalar 25 Hz; 30 Hz (95.20 b0) Level control: 18.00 m
	0.00...32767.00 rpm/Hz/m	Speed/frequency/level	1 = 1 unit
76.42	<i>Stop point 2</i>	Defines the stop speed, frequency or point (Hz/rpm/m) for the second auxiliary motor. See parameter 76.41 Stop point 1 .	Vector: 800 rpm; Scalar 25 Hz; 30 Hz (95.20 b0) Level control: 18.00 m
76.43	<i>Stop point 3</i>	Defines the stop speed, frequency or point (Hz/rpm/m) for the third auxiliary motor. See parameter 76.41 Stop point 1 .	Vector: 800 rpm; Scalar 25 Hz; 30 Hz (95.20 b0) Level control: 18.00 m

No.	Name/Value	Description	Def/FbEq16
76.44	<i>Stop point 4</i>	Defines the stop speed, frequency or point (Hz/rpm/m) for the fourth follower pump/auxiliary motor. See parameter 76.41 Stop point 1 .	Vector: 800 rpm; Scalar 25 Hz; 30 Hz (95.20 b0) Level control: 18.00 m
76.45	<i>Stop point 5</i>	Defines the stop speed, frequency or point (Hz/rpm/m) for the fifth follower pump/auxiliary motor. See parameter 76.41 Stop point 1 .	Vector: 800 rpm; Scalar 25 Hz; 30 Hz (95.20 b0) Level control: 18.00 m
76.46	<i>Stop point 6</i>	Defines the stop speed, frequency or point (Hz/rpm/m) for the sixth follower pump/auxiliary motor. See parameter 76.41 Stop point 1 . For IPC only	Vector: 800 rpm; Scalar 25 Hz; 30 Hz (95.20 b0) Level control: 18.00 m
76.47	<i>Stop point 7</i>	Defines the stop speed, frequency or point (Hz/rpm/m) for the seventh follower pump/auxiliary motor. See parameter 76.41 Stop point 1 . For IPC only	Vector: 800 rpm; Scalar 25 Hz; 30 Hz (95.20 b0) Level control: 18.00 m
76.48	<i>Stop point 8</i>	Defines the stop point for the eighth follower pump/auxiliary motor. See parameter 76.41 Stop point 1 . Note: This parameter is active in Level control only.	Level control: 18.00 m
76.50	<i>LC full speed point</i>	Defines the level at which all the pumps will run at maximum speed/frequency defined with parameter 30.12 Maximum speed or 30.14 Maximum frequency .	Level control: 45.00 m
	0.00...32767.00 m	Level control full speed level.	1 = 1 m
76.51	<i>LC level source</i>	Defines the source for level measurement.	AI2 scaled
	AI1 scaled	12.12 AI1 scaled value (see page 321).	1
	AI2 scaled	12.22 AI2 scaled value (see page 323).	2
	AI1 percent	12.101 AI1 percent value (see page 324).	8
	AI2 percent	12.102 AI2 percent value (see page 324).	9
76.52	<i>LC level unit</i>	Defines the unit for level control measurement (parameter 76.05 Measured level).	meters
	percent	Level control is measured in percent.	4
	feet	Level control is measured in feet.	27
	centimeters	Level control is measured in centimeter.	69
	meters	Level control is measured in meter.	72
	inches	Level control is measured in inch.	73
76.53	<i>LC efficient speed</i>	Defines the most economical speed for pumping. The level control follows this speed as long as the speed is below the level defined with parameter 76.50 LC full speed point .	Vector: 1300 rpm Scalar: 44 Hz

No.	Name/Value	Description	Def/FbEq16
	-2147483648... 2147483520 unit	Efficient speed for pumping.	1 = 1 unit
76.54	<i>LC max time at level</i>	Defines the maximum time that the tank level can be between two start levels before forcing already running pumps to full speed. With constant inflow, the new starting pump will change the level to avoid caking.	1.0 h
	0.0...1800.0 h	Level control maximum time in hours.	1 = 1
76.55	<i>Start delay</i>	Defines the delay time for starting the auxiliary motors. See parameter 76.31 Start point 1 .	10.00 s
	0.00...12600.00 s	Time delay.	1 = 1 s
76.56	<i>Stop delay</i>	Defines the delay time for starting the auxiliary motors. See parameter 76.31 Stop point 1 .	10.00 s
	0.00...12600.00 s	Time delay.	1 = 1 s
76.57	<i>PFC speed hold on</i>	Hold time for auxiliary motor switch-on. See parameter 76.31 Start point 1 .	0.00 s
	0.00...1000.00 s	Time.	1 = 1 s
76.58	<i>PFC speed hold off</i>	Hold time for auxiliary motor switch-off. See parameter 76.31 Stop point 1 .	0.00 s
	0.00...1000.00 s	Time.	1 = 1 s
76.59	<i>PFC contactor delay</i>	Start delay for the motor that is directly controlled by the drive. This does not affect the starting of the auxiliary motors.  WARNING! There must always be a delay set if the motors are equipped with star-delta starters. The delay must be set longer than the time setting of the starter. After the motor is switched on by the relay output of the drive, there must be enough time for the star-delta starter to first switch to star and then back to delta before the motor is connected to the drive.	0.50 s
	0.20...600.00 s	Time delay.	1 = 1 s
76.60	<i>PFC ramp acceleration time</i>	Defines the acceleration time for the drive motor speed compensation, when an auxiliary motor is stopped. This ramp time is also used for the drive motor to accelerate after an autochange has occurred. The parameter sets the ramp-up time as seconds from zero to maximum frequency (not from the previous reference to the new reference).	1.00 s
	0.00...1800.00 s	Time.	1 = 1 s
76.61	<i>PFC ramp deceleration time</i>	Defines the deceleration time for the drive motor speed compensation, when an auxiliary motor is started. This ramp time is also used for the drive motor to decelerate after an autochange has occurred. The parameter sets the ramp-up time as seconds from maximum to zero frequency (not from the previous reference to the new reference).	1.00 s
	0.00...1800.00 s	Time.	1 = 1 s

No.	Name/Value	Description	Def/FbEq16
76.62	<i>IPC smooth acceleration time</i>	Defines the ramp time of a new starting pump. A pump that is started by current master follows the speed until all the pumps rotate at the same speed and master role is changed. The smooth acceleration time must be longer than the time defined with parameter 40.33 Set 1 integration time . Note: Quick ramp overrides the smooth ramp. See parameter group 82 Pump protections on page 505 .	20.00 s
	3.00...1800.00 s	IPC smooth acceleration time in seconds.	1 = 1 s
76.63	<i>IPC smooth deceleration time</i>	Defines the ramp time that is used to stop the pump. A pump that is stopped by current master follows the speed until it is stopped completely. The smooth deceleration time must be longer than the time defined with parameter 40.33 Set 1 integration time . Note: Quick ramps overrides the smooth ramp. See parameter group 82 Pump protections on page 505 .	20.00 s
	3.00...1800.00 s	IPC smooth deceleration time in seconds.	1 = 1 s
76.70	<i>PFC Autochange</i>	Defines the way the autochange is triggered. In all cases except Even wear , the start order is moved one step forward each time the autochange occurs. If the start order initially is 1-2-3-4, after the first autochange the order will be 2-3-4-1, etc. For Even wear , the start order will be determined so that the running times of all motors remain within the defined limit. If IPC is used with values Not selected or Selected , the system will automatically select the Even wear value. Note: Autochange only occurs when the speed of the drive is below the speed defined by parameter 76.73 Autochange level . See also section Autochange on page 115 .	Even wear (for IPC) Not selected (for PFC)
	Not selected	Autochange disabled.	0
	Selected	Rising edge starts the autochange if autochange conditions are met.	1
	DI1	Autochange triggered by the rising edge of digital input DI1 (10.02 DI delayed status , bit 0).	2
	DI2	Autochange triggered by the rising edge of digital input DI2 (10.02 DI delayed status , bit 1).	3
	DI3	Autochange triggered by the rising edge of digital input DI3 (10.02 DI delayed status , bit 2).	4
	DI4	Autochange triggered by the rising edge of digital input DI4 (10.02 DI delayed status , bit 3).	5
	DI5	Autochange triggered by the rising edge of digital input DI5 (10.02 DI delayed status , bit 4).	6
	DI6	Autochange triggered by the rising edge of digital input DI6 (10.02 DI delayed status , bit 5).	7
	Timed function 1	Autochange triggered by timed function 1 (bit 0 of 34.01 Timed functions status (see page 410)).	8
	Timed function 2	Autochange triggered by timed function 2 (bit 1 of 34.01 Timed functions status (see page 410)).	9
	Timed function 3	Autochange triggered by timed function 3 (bit 2 of 34.01 Timed functions status (see page 410)).	10

No.	Name/Value	Description	Def/FbEq16
	Fixed interval	Autochange is done when the interval determined in the parameter 76.71 PFC Autochange interval has elapsed.	11
	All stop	Autochange is done when all the motors are stopped. The PID sleep feature (parameters 40.43 Set 1 sleep level ... 40.48 Set 1 wake-up delay) must be used for the drive to stop when the process demand is low.	12
	Even wear	The running time of the motors are balanced by the drive. When the difference in running time between the motors with the least and most running hours exceeds the time defined by parameter 76.72 Maximum wear imbalance , the autochange occurs. The running hours of the motors can be found in group 77 Multipump maintenance and monitoring .	13
	<i>Other [bit]</i>	Source selection (see Terms and abbreviations on page 285).	-
76.71	PFC Autochange interval	Specifies the interval that is used in setting Fixed interval of parameter 76.70 PFC Autochange .	1.00 h
	0.00... 42949672.95 h	Time.	1 = 1 h
76.72	Maximum wear imbalance	Specifies the maximum wear imbalance, or difference in running times between any motor, used by the Even wear setting of parameter 76.70 PFC Autochange .	10.00 h
	0.00...1000000.00 h	Time.	1 = 1 h
76.73	Autochange level	Upper speed limit for the Autochange to occur. The Autochange occurs when: <ul style="list-style-type: none"> the condition defined in 76.70 PFC Autochange is fulfilled and, the speed of the drive motor 01.03 Motor speed % is below the speed limit defined in this parameter. Note: When the value is selected as 0%, this speed limit check is disabled.	100.0%
	0.0...300.0%	Speed/frequency in percentage of the nominal speed or frequency of the drive motor.	1 = 1%
76.74	Autochange auxiliary PFC	Selects whether only auxiliary motors or all motors are included in the Autochange function.	Aux motors only
	All motors	All motors, including the one connected to the drive participates in the autochange. The Autochange logic will connect the drive to each of the motors according to setting of parameter 76.70 PFC Autochange . Note: The first motor (PFC1) also requires the appropriate hardware contactor connections and PFC1 must be defined in one of the relay output source parameters.	0
	Aux motors only	Only auxiliary (direct-on-line) motors are affected by the autochange function. Note: PFC1 refers to the motor that is fixed to the drive and must not be selected in any of the relay output source parameters. Only the starting order of the auxiliary motors will be rotated.	1
76.76	Max stationary time	Defines the maximum time that a low priority pump can be stationary. The IPC system uses pump priorities to start/stop the pumps. This parameter sets the upper limit for stationary time so that the pump blockage can be avoided.	0.0 h

No.	Name/Value	Description	Def/FbEq16
	0.0...214748368.0 h	Maximum stationary time in hours.	1 = 1 h
76.77	<i>Pump priority</i>	Selects the priority of the pump in an IPC system. Note: Parameter 76.76 <i>Max stationary time</i> defines the maximum time that a low priority pump can be stationary.	<i>Normal</i>
	High	High priority pump. The IPC system prefers high priority pump.	1
	Normal	Normal priority pump.	3
	Low	Low priority pump. The low priority pump runs as little as possible. It is started only when the demand requires full pumping capacity.	5
76.81	<i>PFC 1 interlock</i>	Defines if the PFC motor 1 can be started. An interlocked PFC motor cannot be started. 0 = Interlocked (not available) 1 = Available.	<i>Available. PFC motor is available</i>
	Interlocked. PFC motor is not in use	PFC motor is interlocked and not available.	0
	Available. PFC motor is available	PFC motor is available.	1
	DI1	Digital input DI1 (<i>10.02 DI delayed status</i> , bit 0).	2
	DI2	Digital input DI2 (<i>10.02 DI delayed status</i> , bit 1).	3
	DI3	Digital input DI3 (<i>10.02 DI delayed status</i> , bit 2).	4
	DI4	Digital input DI4 (<i>10.02 DI delayed status</i> , bit 3).	5
	DI5	Digital input DI5 (<i>10.02 DI delayed status</i> , bit 4).	6
	DI6	Digital input DI6 (<i>10.02 DI delayed status</i> , bit 5).	7
	Timed function 1	Bit 0 of <i>34.01 Timed functions status</i> (see page 410).	8
	Timed function 2	Bit 1 of <i>34.01 Timed functions status</i> (see page 410).	9
	Timed function 3	Bit 2 of <i>34.01 Timed functions status</i> (see page 410).	10
	<i>Other [bit]</i>	Source selection (see <i>Terms and abbreviations</i> on page 285).	-
76.82	<i>PFC 2 interlock</i>	See parameter 76.81 <i>PFC 1 interlock</i> .	<i>Available. PFC motor is available</i>
76.83	<i>PFC 3 interlock</i>	See parameter 76.81 <i>PFC 1 interlock</i> .	<i>Available. PFC motor is available</i>
76.84	<i>PFC 4 interlock</i>	See parameter 76.81 <i>PFC 1 interlock</i> .	<i>Available. PFC motor is available</i>
76.85	<i>PFC 5 interlock</i>	See parameter 76.81 <i>PFC 1 interlock</i> .	<i>Available. PFC motor is available</i>
76.86	<i>PFC 6 interlock</i>	See parameter 76.81 <i>PFC 1 interlock</i> .	<i>Available. PFC motor is available</i>
76.90	<i>LC low level switch</i>	Selects the source for digital low level switch.	<i>Selected</i>
	Not selected	Low level switch is inactive.	0
	Selected	Low level switch is active.	1
	DI1	Digital input DI1 (<i>10.02 DI delayed status</i> , bit 0).	2

No.	Name/Value	Description	Def/FbEq16
	DI2	Digital input DI2 (<i>10.02 DI delayed status</i> , bit 1).	3
	DI3	Digital input DI3 (<i>10.02 DI delayed status</i> , bit 2).	4
	DI4	Digital input DI4 (<i>10.02 DI delayed status</i> , bit 3).	5
	DI5	Digital input DI5 (<i>10.02 DI delayed status</i> , bit 4).	6
	DI6	Digital input DI6 (<i>10.02 DI delayed status</i> , bit 5).	7
	Supervision 1	Bit 0 of <i>32.01 Supervision status</i> (see page 403).	8
	Supervision 2	Bit 1 of <i>32.01 Supervision status</i> (see page 403).	9
	Supervision 3	Bit 2 of <i>32.01 Supervision status</i> (see page 403).	10
	<i>Other [bit]</i>	Source selection (see <i>Terms and abbreviations</i> on page 285).	-
76.91	LC high level switch	Selects the source for digital high level switch.	<i>Selected</i>
	Not selected	High level switch is inactive.	0
	Selected	High level switch is active.	1
	DI1	Digital input DI1 (<i>10.02 DI delayed status</i> , bit 0).	2
	DI2	Digital input DI2 (<i>10.02 DI delayed status</i> , bit 1).	3
	DI3	Digital input DI3 (<i>10.02 DI delayed status</i> , bit 2).	4
	DI4	Digital input DI4 (<i>10.02 DI delayed status</i> , bit 3).	5
	DI5	Digital input DI5 (<i>10.02 DI delayed status</i> , bit 4).	6
	DI6	Digital input DI6 (<i>10.02 DI delayed status</i> , bit 5).	7
	Supervision 1	Bit 0 of <i>32.01 Supervision status</i> (see page 403).	8
	Supervision 2	Bit 1 of <i>32.01 Supervision status</i> (see page 403).	9
	Supervision 3	Bit 2 of <i>32.01 Supervision status</i> (see page 403).	10
	<i>Other [bit]</i>	Source selection (see <i>Terms and abbreviations</i> on page 285).	-
76.92	LC low level action	Selects the action for drive to indicate when digital low level switch is activated. See parameter <i>76.90 LC low level switch</i> (page 495).	<i>Warning</i>
	No action	Low level switch is disabled and does not generate any event.	0
	Warning	Low level switch generates warning <i>D509 Low level</i> .	1
	Fault	Low level switch trips on fault <i>D403 Low level</i> .	2
76.93	LC high level action	Selects the action for drive to indicate when digital high level switch is activated. See parameter <i>76.91 LC high level switch</i> (page 496).	<i>Warning</i>
	No action	High level switch is disabled and does not generate any event.	0
	Warning	High level switch generates warning <i>D508 High level</i> .	1
	Fault	High level switch trips on fault <i>D402 High level</i> .	2
76.95	Regulator bypass control	Defines if direct-on-line pumps are automatically started and stopped. This setting can be used in applications with a low number of sensors and low accuracy requirements.	<i>Disable</i>
	Disable	Automatic starting and stopping is disabled.	0
	Enable	Automatic starting and stopping is enabled.	1
	<i>Other [bit]</i>	Source selection (see <i>Terms and abbreviations</i> on page 285).	-

No.	Name/Value	Description	Def/FbEq16															
76.101	<i>IPC parameter synchronization</i>	Defines parameter synchronization in IPC system.	<i>Enable</i>															
	Disable	Parameter synchronization is disabled.	1															
	Enable	Parameter synchronization is enabled.	2															
76.102	<i>IPC synchronization settings</i>	Selects the settings that are synchronized between drives in inverter-to-inverter communication bus. The process PID and IPC parameters are synchronized. Note: This parameter does not synchronize AI parameters.	0b0110															
<table border="1"> <thead> <tr> <th>Bit</th> <th>Name</th> <th>Value</th> </tr> </thead> <tbody> <tr> <td>0</td> <td>AI parameters</td> <td>Parameter group <i>12 Standard AI</i>.</td> </tr> <tr> <td>1</td> <td>Process PID set 1 parameters</td> <td>Parameter group <i>40 Process PID set 1</i>. Parameters <i>19.11 Ext1/Ext2 selection</i>, <i>20.06 Ext2 commands</i>, <i>20.08 Ext2 in1 source</i>, <i>22.18 Ext2 speed ref1</i> and <i>28.15 Ext2 frequency ref1</i>.</td> </tr> <tr> <td>2</td> <td>IPC parameters</td> <td>Parameter group <i>76 Multipump configuration</i> and <i>77 Multipump maintenance and monitoring</i>.</td> </tr> <tr> <td>3...15</td> <td>Reserved</td> <td></td> </tr> </tbody> </table>				Bit	Name	Value	0	AI parameters	Parameter group <i>12 Standard AI</i> .	1	Process PID set 1 parameters	Parameter group <i>40 Process PID set 1</i> . Parameters <i>19.11 Ext1/Ext2 selection</i> , <i>20.06 Ext2 commands</i> , <i>20.08 Ext2 in1 source</i> , <i>22.18 Ext2 speed ref1</i> and <i>28.15 Ext2 frequency ref1</i> .	2	IPC parameters	Parameter group <i>76 Multipump configuration</i> and <i>77 Multipump maintenance and monitoring</i> .	3...15	Reserved	
Bit	Name	Value																
0	AI parameters	Parameter group <i>12 Standard AI</i> .																
1	Process PID set 1 parameters	Parameter group <i>40 Process PID set 1</i> . Parameters <i>19.11 Ext1/Ext2 selection</i> , <i>20.06 Ext2 commands</i> , <i>20.08 Ext2 in1 source</i> , <i>22.18 Ext2 speed ref1</i> and <i>28.15 Ext2 frequency ref1</i> .																
2	IPC parameters	Parameter group <i>76 Multipump configuration</i> and <i>77 Multipump maintenance and monitoring</i> .																
3...15	Reserved																	
	0000h...FFFFh	Synchronization settings	1 = 1															
76.105	<i>IPC synchronization checksum</i>	Displays the calculated parameter checksum (CRC) of the parameter groups selected with parameter <i>76.102 IPC synchronization settings</i> . If the value of this parameter is same on all the drives, then the configuration is also synchronized correctly.	-															
	0000h...FFFFh	Checksum.	1 = 1															
77 Multipump maintenance and monitoring		PFC (Pump and fan control) and multipump maintenance and monitoring parameters.																
77.10	<i>PFC runtime change</i>	Enables the reset, or arbitrary setting, of <i>77.11 Pump 1 running time ... 77.18 Pump 8 running time</i> .	<i>Done</i>															
	Done	The parameter automatically reverts back to this value.	0															
	Set any PFC run time	Enables the setting of <i>77.11 Pump 1 running time ... 77.18 Pump 8 running time</i> .	1															
	Reset PFC1 run time	Resets parameter <i>77.11 Pump 1 running time</i> .	2															
	Reset PFC2 run time	Resets parameter <i>77.12 Pump 2 running time</i> .	3															
	Reset PFC3 run time	Resets parameter <i>77.13 Pump 3 running time</i> .	4															
	Reset PFC4 run time	Resets parameter <i>77.14 Pump 4 running time</i> .	4															
	Reset PFC5 run time	Resets parameter <i>77.15 Pump 5 running time</i>																
	Reset PFC6 run time	Resets parameter <i>77.16 Pump 6 running time</i> .	7															
77.11	<i>Pump 1 running time</i>	Running time counter of pump/fan 1. Can be set or reset by parameter <i>77.10 PFC runtime change</i> .	0.00 h															

No.	Name/Value	Description	Def/FbEq16																														
	0.00... 42949672.95 h	Time	1 = 1 h																														
77.12	<i>Pump 2 running time</i>	See parameter <i>77.11 Pump 1 running time</i> .	0.00 h																														
77.13	<i>Pump 3 running time</i>	See parameter <i>77.11 Pump 1 running time</i> .	0.00 h																														
77.14	<i>Pump 4 running time</i>	See parameter <i>77.11 Pump 1 running time</i> .	0.00 h																														
77.15	<i>Pump 5 running time</i>	See parameter <i>77.11 Pump 1 running time</i> .	0.00 h																														
77.16	<i>Pump 6 running time</i>	See parameter <i>77.11 Pump 1 running time</i> .	0.00 h																														
77.17	<i>Pump 7 running time</i>	Running time counter of pump 7. For IPC only.	0.00 h																														
77.18	<i>Pump 8 running time</i>	Running time counter of pump 8. For IPC only.	0.00 h																														
77.20	<i>IPC online pumps</i>	Displays the pumps which can establish connection through inverter-to-inverter communication. For example, in a three pump system, drive 1 and drive 2 can see each other but drive 3 cannot see other drives. Drive 1 = 0011b, Drive 2 = 0011b, Drive 3 = 0100b	-																														
<table border="1" style="width: 100%; border-collapse: collapse;"> <thead> <tr> <th>Bit</th> <th>Name</th> <th>Descriptions</th> </tr> </thead> <tbody> <tr> <td>0</td> <td>Node 1</td> <td>Pump 1 is online.</td> </tr> <tr> <td>1</td> <td>Node 2</td> <td>Pump 2 is online.</td> </tr> <tr> <td>2</td> <td>Node 3</td> <td>Pump 3 is online.</td> </tr> <tr> <td>3</td> <td>Node 4</td> <td>Pump 4 is online.</td> </tr> <tr> <td>4</td> <td>Node 5</td> <td>Pump 5 is online.</td> </tr> <tr> <td>5</td> <td>Node 6</td> <td>Pump 6 is online.</td> </tr> <tr> <td>6</td> <td>Node 7</td> <td>Pump 7 is online.</td> </tr> <tr> <td>7</td> <td>Node 8</td> <td>Pump 8 is online.</td> </tr> <tr> <td>8...15</td> <td>Reserved</td> <td></td> </tr> </tbody> </table>				Bit	Name	Descriptions	0	Node 1	Pump 1 is online.	1	Node 2	Pump 2 is online.	2	Node 3	Pump 3 is online.	3	Node 4	Pump 4 is online.	4	Node 5	Pump 5 is online.	5	Node 6	Pump 6 is online.	6	Node 7	Pump 7 is online.	7	Node 8	Pump 8 is online.	8...15	Reserved	
Bit	Name	Descriptions																															
0	Node 1	Pump 1 is online.																															
1	Node 2	Pump 2 is online.																															
2	Node 3	Pump 3 is online.																															
3	Node 4	Pump 4 is online.																															
4	Node 5	Pump 5 is online.																															
5	Node 6	Pump 6 is online.																															
6	Node 7	Pump 7 is online.																															
7	Node 8	Pump 8 is online.																															
8...15	Reserved																																
0000h...FFFFh		Pump status	1 = 1																														

No.	Name/Value	Description	Def/FbEq16																		
77.21	<i>IPC comm loss status</i>	Displays the drives communication loss status. You can override default communication loss actions by setting start interlock or constant speed based on the bit values. Note: Bits will reset to zero when communication is restored.	-																		
<table border="1"> <thead> <tr> <th>Bit</th> <th>Name</th> <th>Descriptions</th> </tr> </thead> <tbody> <tr> <td>0</td> <td>Running master in comm loss</td> <td>The running master drive has lost the connection to other drives. By default, this drive continues as a running master.</td> </tr> <tr> <td>1</td> <td>Running follower (master enable) in comm loss</td> <td>The running follower drive which is set as master enabled drive has lost the connection to other drives. By default, this drive will be a master (offline).</td> </tr> <tr> <td>2</td> <td>Standby master enabled in comm loss</td> <td>The master enabled drive which is in standby mode has lost the connection to other drives. By default, this drive remains in standby mode if already running drives can maintain the process.</td> </tr> <tr> <td>3</td> <td>Standby master disabled in comm loss</td> <td>The master disabled drive which is in standby mode has lost the connection to other drives. By default, this drive remains in standby mode.</td> </tr> <tr> <td>4...15</td> <td>Reserved</td> <td></td> </tr> </tbody> </table>				Bit	Name	Descriptions	0	Running master in comm loss	The running master drive has lost the connection to other drives. By default, this drive continues as a running master.	1	Running follower (master enable) in comm loss	The running follower drive which is set as master enabled drive has lost the connection to other drives. By default, this drive will be a master (offline).	2	Standby master enabled in comm loss	The master enabled drive which is in standby mode has lost the connection to other drives. By default, this drive remains in standby mode if already running drives can maintain the process.	3	Standby master disabled in comm loss	The master disabled drive which is in standby mode has lost the connection to other drives. By default, this drive remains in standby mode.	4...15	Reserved	
Bit	Name	Descriptions																			
0	Running master in comm loss	The running master drive has lost the connection to other drives. By default, this drive continues as a running master.																			
1	Running follower (master enable) in comm loss	The running follower drive which is set as master enabled drive has lost the connection to other drives. By default, this drive will be a master (offline).																			
2	Standby master enabled in comm loss	The master enabled drive which is in standby mode has lost the connection to other drives. By default, this drive remains in standby mode if already running drives can maintain the process.																			
3	Standby master disabled in comm loss	The master disabled drive which is in standby mode has lost the connection to other drives. By default, this drive remains in standby mode.																			
4...15	Reserved																				
0000h...FFFFh		Communication loss status	1 = 1																		

80 Flow calculation		Actual flow calculation. Note: Parameters are dynamically hidden based on selection of flow calculation mode. Parameters are visible according to the selection of parameter 80.13 Flow feedback function .	
80.01	<i>Actual flow</i>	Actual system flow that is either calculated from the pressure difference, measured directly or estimated from the pump curves. The calculation method is selected with parameter 80.13 Flow feedback function . See control chain diagram <i>PID flow calculation</i> on page 276.	-
	-200000.00... 200000.00 m ³ /h	Actual flow.	1 = 1 m ³ /h
80.02	<i>Actual flow</i>	Shows the percentage of parameter 80.01 Actual flow from 80.15 Maximum flow .	-
	-100.00...100.00%	Flow percentage of maximum flow.	100 = 1%
80.03	<i>Total flow</i>	Shows cumulative calculated flow.	-
	0.00... 21474836.00 m ³	Total calculated flow.	
80.04	<i>Specific energy</i>	Shows the ratio of pump flow rate and power input.	0.00
	0.00... 32767.95 m ³ /kWh	Specific energy of the pump.	1 = 1 m ³ /kWh
80.05	<i>Estimated pump head</i>	Shows the estimated head produced by the pump.	-
	0.00...32767.00 m	Estimated pump head.	1 = 1 m
80.11	<i>Flow feedback 1 source</i>	Selects the source for the flow feedback 1.	<i>Not selected</i>

No.	Name/Value	Description	Def/FbEq16
	Not selected	Feedback not used.	0
	AI1 scaled	12.12 AI1 scaled value (see page 321).	1
	AI2 scaled	12.22 AI2 scaled value (see page 323).	2
	Freq in scaled	11.39 Freq in 1 scaled value (see page 319).	3
	AI1 percent	12.101 AI1 percent value (see page 324).	8
	AI2 percent	12.102 AI2 percent value (see page 324).	9
	Feedback data storage	40.91 Feedback data storage (see page 452).	10
	<i>Other</i>	Source selection (see Terms and abbreviations on page 285).	-
80.12	<i>Flow feedback 2 source</i>	Selects the source for the flow feedback 2.	<i>Not selected</i>
	Not selected	Feedback not used.	0
	AI1 scaled	12.12 AI1 scaled value (see page 321).	1
	AI2 scaled	12.22 AI2 scaled value (see page 323).	2
	Freq in scaled	11.39 Freq in 1 scaled value (see page 319).	3
	AI1 percent	12.101 AI1 percent value (see page 324).	8
	AI2 percent	12.102 AI2 percent value (see page 324).	9
	Feedback data storage	40.91 Feedback data storage (see page 452).	10
	<i>Other</i>	Source selection (see Terms and abbreviations on page 285).	-
80.13	<i>Flow feedback function</i>	Selects a function between the flow feedback sources selected by parameters 80.11 Flow feedback 1 source and 80.12 Flow feedback 2 source . The result of the function (for any selection) is multiplied by parameter 80.14 Flow feedback multiplier .	<i>In1</i>
	In1	Use 80.11 Flow feedback 1 source directly as the flow value.	0
	In2	Use 80.12 Flow feedback 2 source directly as the flow value.	1
	Reserved		2...7
	sqrt(In1)	Flow is calculated as a square root of a differential pressure measurement: $k\sqrt{\Delta P}$ The differential pressure value is selected with 80.11 Flow feedback 1 source .	8
	sqrt(In1-In2)	Flow is calculated as a square root of two measured absolute pressure measurements: $k\sqrt{(P_1 - P_2)}$ The pressure measurement sources are selected with 80.11 Flow feedback 1 source and 80.12 Flow feedback 2 source .	9

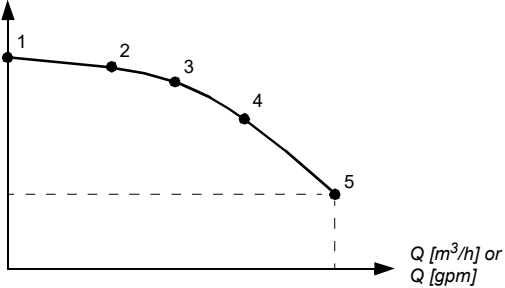
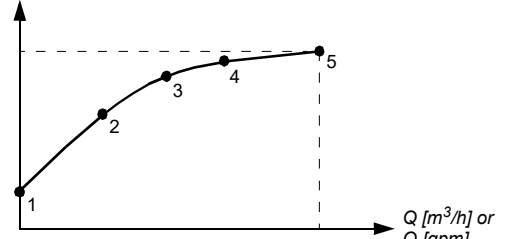
No.	Name/Value	Description	Def/FbEq16
	HQ curve	<p>The HQ curve is used for flow calculation. You can configure pressure sensor settings with parameter group 81 Sensor settings. The figure below shows the HQ performance curve of the pump for the flow calculation function.</p> <p>$H [m]$ or $H [ft]$</p>  <p style="text-align: right;">$Q [m^3/h]$ or $Q [gpm]$</p>	100
	PQ curve	<p>The PQ curve is used for flow calculation. You can configure pressure sensor settings with parameter group 81 Sensor settings. The figure below shows the PQ performance curve of the pump for the flow calculation function.</p> <p>$P [kW]$ or $P [hp]$</p>  <p style="text-align: right;">$Q [m^3/h]$ or $Q [gpm]$</p>	101
80.14	Flow feedback multiplier	Defines the multiplier (k) used with the flow calculation The output value of 80.13 Flow feedback function is multiplied by this value.	1.00
	-200000.00... 200000.00	Multiplier.	1 = 1
80.15	Maximum flow	Defines the nominal maximum flow of the system. This value is used to calculate the actual flow percentage value so that the value 100% for 80.02 corresponds to the value of this parameter.	1000.00 m ³ /h
	-200000.00... 200000.00 m ³ /h	Limit for maximum flow protection.	1 = 1 m ³ /h
80.16	Minimum flow	Defines the nominal minimum flow of the system.	1.00
	-200000.00... 200000.00 m ³ /h	Limit for minimum flow protection.	1 = 1 m ³ /h

No.	Name/Value	Description	Def/FbEq16
80.17	<i>Maximum flow protection</i>	Selects the action for maximum flow protection function. See parameters 22.41 Speed ref safe and 28.41 Frequency ref safe .	<i>No action</i>
	No action	Maximum flow protection is disabled.	0
	Warning	Drive generates warning D50C Maximum flow protection .	1
	Fault	Drive trips on fault D406 Maximum flow protection .	2
	Speed ref safe	Speed reference safe is activated.	3
80.18	<i>Minimum flow protection</i>	Selects the action for minimum flow protection function. See parameters 22.41 Speed ref safe and 28.41 Frequency ref safe .	<i>No action</i>
	No action	Minimum flow protection is disabled.	0
	Warning	Drive generates warning D50D Minimum flow protection .	1
	Fault	Drive trips on fault D407 Minimum flow protection .	2
	Speed ref safe	Speed reference safe is activated.	3
80.19	<i>Flow check delay</i>	Defines the time after motor start when the flow protection is active.	5.00 s
	0.00...3600.00 s	Flow check delay.	1 = 1 s
80.21	<i>Flow pump nominal speed</i>	Definition speed of the pump curve used, normally the pump's nominal speed. Used as reference speed for sensorless flow calculation, see section Sensorless flow calculation on page 121 . Only visible in vector control mode.	Value of 99.09 Motor nominal speed
	0.0...30000.0 rpm	Pump speed.	1 = 1 rpm
80.22	<i>Pump inlet diameter</i>	Defines the pump inlet pipe diameter.	0.100 m
	0.010... 32767.000 m	Pump inlet pipe diameter.	1 = 1 m
80.23	<i>Pump outlet diameter</i>	Defines the pump outlet pipe diameter.	0.100 m
	0.010... 32767.000 m	Pump outlet pipe diameter.	1 = 1 m
80.26	<i>Calculation minimum speed</i>	Defines the speed limit below which flow is not calculated.	5.00 m
	0.00...32767.00 m	Minimum speed limit for flow calculation.	1 = 1 m
80.28	<i>Density</i>	Defines the density of the fluid to be pumped for the flow calculation function.	1000.00 kg/m ³
	0.00... 32767.00 kg/m ³	Fluid density.	1 = 1 kg/m ³
80.29	<i>Total flow reset</i>	Resets signal 80.02 Total flow .	<i>Not selected</i>
	Not selected	Total flow reset is not selected.	0
	Reset	Resets cumulative flow counter. Note: The value reverts automatically to <i>Not selected</i> after the flow is reset.	1
80.40	<i>HQ curve H1</i>	Defines the head at point 1 of the HQ performance curve.	0.00 m
	0.00...32767.00 m	Head at point 1 of the HQ curve.	1 = 1 m
80.41	<i>HQ curve H2</i>	Defines the head at point 2 of the HQ performance curve. See parameter 80.40 HQ curve H1 (page 502).	0.00 m

No.	Name/Value	Description	Def/FbEq16
80.42	<i>HQ curve H3</i>	Defines the head at point 3 of the HQ performance curve. See parameter <i>80.40 HQ curve H1</i> (page 502).	0.00 m
80.43	<i>HQ curve H4</i>	Defines the head at point 4 of the HQ performance curve. See parameter <i>80.40 HQ curve H1</i> (page 502).	0.00 m
80.44	<i>HQ curve H5</i>	Defines the head at point 5 of the HQ performance curve. See parameter <i>80.40 HQ curve H1</i> (page 502).	0.00 m
80.50	<i>PQ curve P1</i>	Defines the power input of pump at point 1 on the PQ performance curve.	0.00 kW
	0.00...32767.00 kW	Power input of pump at point 1.	1 = 1 kW
80.51	<i>PQ curve P2</i>	Defines the power input of pump at point 2 on the PQ performance curve. See parameter <i>80.50 PQ curve P1</i> (page 503).	0.00
80.52	<i>PQ curve P3</i>	Defines the power input of pump at point 3 on the PQ performance curve. See parameter <i>80.50 PQ curve P1</i> (page 503).	0.00
80.53	<i>PQ curve P4</i>	Defines the power input of pump at point 4 on the PQ performance curve. See parameter <i>80.50 PQ curve P1</i> (page 503).	0.00
80.54	<i>PQ curve P5</i>	Defines the power input of pump at point 5 on the PQ performance curve. See parameter <i>80.50 PQ curve P1</i> (page 503).	0.00
80.60	<i>Q value Q1</i>	Defines the flow rate at point 1 on the PQ performance curve.	0.00 m ³ /h
	0.00... 200000.00 m ³ /h	Flow rate at point 1 of the PQ curve.	1 = 1 m ³ /h
80.61	<i>Q value Q2</i>	Defines the flow rate at point 2 on the PQ performance curve. See parameter <i>80.60 Q value Q1</i> (page 503).	0.00 m ³ /h
80.62	<i>Q value Q3</i>	Defines the flow rate at point 3 on the PQ performance curve. See parameter <i>80.60 Q value Q1</i> (page 503).	0.00 m ³ /h
80.63	<i>Q value Q4</i>	Defines the flow rate at point 4 on the PQ performance curve. See parameter <i>80.60 Q value Q1</i> (page 503).	0.00 m ³ /h
80.64	<i>Q value Q5</i>	Defines the flow rate at point 5 on the PQ performance curve. See parameter <i>80.60 Q value Q1</i> (page 503).	0.00 m ³ /h

81 Sensor settings		Sensor settings for inlet and outlet pressure protection function.	
81.01	<i>Actual inlet pressure</i>	Shows the actual inlet pressure. Note: By default the parameter unit will be bar. However, the unit can be changed according to the parameter <i>81.20 Pressure unit</i> .	-
	0.00...32767.00 bar	Actual inlet pressure.	1 = 1 bar
81.02	<i>Actual outlet pressure</i>	Shows the actual outlet pressure.	-
	0.00...32767.00 bar	Actual outlet pressure.	1 = 1 bar
81.10	<i>Inlet pressure source</i>	Selects the primary source used for pump inlet pressure measurement.	<i>Not selected</i>
	Not selected	None.	0
	AI1 scaled	Parameter <i>12.12 AI1 scaled value</i> .	1
	AI2 scaled	Parameter <i>12.22 AI2 scaled value</i> .	2

No.	Name/Value	Description	Def/FbEq16
	Freq in scaled	Parameter 11.39 Freq in 1 scaled value.	3
	AI1 percent	Parameter 12.101 AI1 percent value.	8
	AI2 percent	Parameter 12.102 AI2 percent value.	9
	Feedback data storage	Parameter 40.91 Feedback data storage.	10
	<i>Other</i>	Source selection (see Terms and abbreviations on page 285).	-
81.11	Outlet pressure source	Selects the primary source used for pump outlet pressure measurement.	<i>Not selected</i>
	Not selected	None.	0
	AI1 scaled	Parameter 12.12 AI1 scaled value.	1
	AI2 scaled	Parameter 12.22 AI2 scaled value.	2
	Freq in scaled	Parameter 11.39 Freq in 1 scaled value.	3
	AI1 percent	Parameter 12.101 AI1 percent value.	8
	AI2 percent	Parameter 12.102 AI2 percent value.	9
	Feedback data storage	Parameter 40.91 Feedback data storage.	10
	<i>Other</i>	Source selection (see Terms and abbreviations on page 285).	-
81.12	Sensors height difference	Defines the height difference between inlet and outlet pressure sensors for flow calculation.	0.00 m
	0.00...32767.00 m	Sensors height difference.	1 = 1 m
81.20	Pressure unit	Selects the unit of pressure.	<i>bar</i>
	bar	Pressure.	0
	kPa	Kilo pascal.	1
	psi	Pound per square inch.	2
	Pa	Pascal.	3
81.21	Flow unit	Selects the unit of flow. The selection affects total flow and specific energy units.	<i>m³/h</i>
	m ³ /h	Cubic meter per hour.	0
	l/s	Liters per second.	1
	gpm	US gallon per minute.	2
81.22	Length unit	Selects the unit of estimated head points, sensors height difference and pump inlet/outlet diameters.	<i>meters</i>
	centimeters	Length unit in centimeter.	69
	meters	Length unit in meter.	72
	Inches	Length unit in inch.	73
	feet	Length unit in feet.	27
81.23	Density unit	Selects the unit of density.	<i>kg/m³</i>
	kg/m ³	Kilograms per cubic meter.	0
	kg/l	Kilograms per liter.	1
	lb/gal	Pounds per US gallon.	2

No.	Name/Value	Description	Def/FbEq16
82 Pump protections			
Settings for quick ramp functions as well as pump protection functions soft pipe fill and dry pump protection. See sections <i>Ramps – Quick ramps</i> (page 128), <i>Soft pipe fill</i> (page 121) and <i>Dry pump protection</i> (page 127).			
82.01	<i>Quick ramp accel. mode</i>	Enables quick ramp mode for acceleration with quick ramp set 1 (in legacy mode or with updated functionality) and/or with quick ramp set 2 (in legacy mode or with updated functionality). Legacy mode is compatible with software versions before v2.12. Quick ramp set 1 acceleration properties are configured with parameters <i>82.05 1st quick ramp accel. time</i> and <i>82.06 Final quick ramp decel. time</i> . Quick ramp 2 acceleration properties are configured with parameters <i>82.10 2nd quick ramp accel. time</i> and <i>82.12 2nd quick ramp accel. limit</i> . For details, see section <i>Ramps – Quick ramps</i> (page 128).	<i>Disabled</i>
	Disabled	Quick ramp mode is disabled.	0
	Use 1 quick ramp (legacy)	Quick ramp set 1 is and set 2 are used (in legacy mode compatible with software versions before v2.12).	1
	Use 2 quick ramps (legacy)	Both quick ramp set 1 and set 2 are used (in legacy mode compatible with software versions before v2.12).	2
	Use 1 quick ramp	Quick ramp set 1 is used.	3
	Use 2 quick ramps	Both quick ramp set 1 and set 2 are used.	4
82.02	<i>Quick ramp decel. mode</i>	Enables quick ramp mode for deceleration with quick ramp set 1 (in legacy mode or with updated functionality) or with quick ramp set 2 (in legacy mode or with updated functionality).	<i>Follow accel. limits</i>
	Disabled	Quick ramp mode is disabled.	0
	Use 1 quick ramp (legacy)	Quick ramp set 1 is used (in legacy mode compatible with software versions before v2.12).	1
	Use 2 quick ramps (legacy)	Both quick ramp set 1 and set 2 are used (in legacy mode compatible with software versions before v2.12).	2
	Use 1 quick ramp	Quick ramp set 1 is used.	3
	Use 2 quick ramps	Both quick ramp set 1 and set 2 are used.	4
	Follow accel. limits	Use the same configuration (mode and limits) for deceleration that is used for acceleration.	5
82.05	<i>1st quick ramp accel. time</i>	Defines the quick ramp set 1 acceleration rate.	3.00 s
	0.10...1800.00 s	Time.	100 = 1 s
82.06	<i>Final quick ramp decel. time</i>	Defines the quick ramp set 1 deceleration rate. The deceleration rate is defined as the time to decelerate from the speed value defined by parameters <i>46.01 Speed scaling</i> or <i>46.02 Frequency scaling</i> to zero speed. This deceleration rate is effective from speed/frequency defined by parameter <i>82.07 1st quick ramp accel. limit</i> to zero.	3.00 s
	0.10...1800.00 s	Time.	100 = 1 s
82.07	<i>1st quick ramp accel. limit</i>	Defines the acceleration limit for quick ramp 1. Above this speed/frequency, the drive uses either quick ramp 2 and normal ramp time or only normal ramp time depending on parameter <i>82.01 Quick ramp accel. mode</i> .	30 unit

No.	Name/Value	Description	Def/FbEq16
	0...120 Hz / 0...120 rpm	Frequency/Speed limit.	1 = 1 unit
82.08	<i>Final quick ramp decel. limit</i>	Defines the deceleration limit for quick ramp 2.	40 unit
	0...120 Hz / 0...120 rpm	Frequency/Speed limit.	1 = 1 unit
82.10	<i>2nd quick ramp accel. time</i>	Defines the quick ramp set 2 acceleration rate. The acceleration rate is defined as the time to accelerate from zero speed to the speed value defined by parameter 46.01 Speed scaling or 46.02 Frequency scaling . This acceleration rate is effective in speed/frequency range defined by parameters 82.07 1st quick ramp accel. limit and 82.12 2nd quick ramp accel. limit .	10.00 s
	0.10...1800.00 s	Time.	100 = 1 s
82.11	<i>2nd quick ramp decel. time</i>	Defines the quick ramp set 2 deceleration rate. The deceleration rate is defined as the time to decelerate from the speed value defined by parameters 46.01 Speed scaling or 46.02 Frequency scaling to zero speed. This deceleration rate is in speed/frequency range defined by parameters 82.07 1st quick ramp accel. limit and 82.12 2nd quick ramp accel. limit .	10.00 s
	0.10...1800.00 s	Time.	100 = 1 s
82.12	<i>2nd quick ramp accel. limit</i>	Defines the acceleration limit for quick ramp 2. Above this speed/frequency, the drive either uses quick ramp 2 or normal ramp time depending on selection in parameter 82.01 Quick ramp accel. mode .	45 unit
	0...120 Hz / 0...120 rpm	Frequency/Speed limit.	1 = 1 unit
82.13	<i>2nd quick ramp decel. limit</i>	Defines the deceleration limit for quick ramp 2.	45 unit
	0...120 Hz / 0...120 rpm	Frequency/Speed limit.	1 = 1 unit
82.14	<i>Oper. quick ramp accel. time (3rd)</i>	Operational acceleration ramp time used during normal operation. Ramp time from zero or from 82.07 1st quick ramp accel. limit or from 82.12 2nd quick ramp accel. limit (which ever is in use and higher) to 46.01 Speed scaling or 46.02 Frequency scaling .	20.00 s
	0.10...1800.00 s	Time.	100 = 1 s
82.15	<i>Oper. quick ramp decel. time (1st)</i>	Operational deceleration ramp time used during normal operation. Ramp time from 46.01 Speed scaling or 46.02 Frequency scaling to 82.13 2nd quick ramp decel. limit or 82.08 Final quick ramp decel. limit or zero speed (which ever is in use and higher).	20.00 s
	0.10...1800.00 s	Time.	100 = 1 s
82.20	<i>Dry run protection</i>	Selects dry run protection mode. See section Dry pump protection (page 127).	<i>No action</i>
	No action	Dry run protection is disabled.	0
	Warning	Dry run protection generates warning D50A Running dry .	1
	Fault	Dry run protection generates fault D404 Running dry .	2
	Fault if running	Dry run protection generates a fault if the source signal is high when running.	3

No.	Name/Value	Description	Def/FbEq16
82.21	<i>Dry run source</i>	Selects the source for dry run protection.	<i>Under load curve</i>
	Under load curve	Activates dry run protection (parameter <i>37.01 ULC output status word</i> , bit 0). See section <i>Diagnostics</i> (page 181).	0
	DI1	Digital input DI1.	1
	DI2	Digital input DI2.	2
	DI3	Digital input DI3.	3
	DI4	Digital input DI4.	4
	DI5	Digital input DI5.	5
	DI6	Digital input DI6.	6
	Supervision 1	Activates dry run protection.	7
	Supervision 2	Activates dry run protection.	8
	Supervision 3	Activates dry run protection.	9
82.25	<i>Soft pipe fill supervision</i>	Selects the drive action in case the system does not reach the setpoint in time defined with parameter <i>82.26 Time-out limit</i> . The time is calculated with the last reference change in parameter <i>40.03 Process PID setpoint actual</i> . See section <i>Soft pipe fill</i> (page 121).	<i>No action</i>
	No action	Soft pipe fill time-out is disabled.	0
	Warning	Soft pipe fill supervision function generates warning <i>D50B Pipe fill-timeout</i> .	1
	Fault	Soft pipe fill supervision function generates fault <i>D405 Pipe fill-timeout</i> .	2
82.26	<i>Time-out limit</i>	Defines the delay time at which setpoint must be reached after last change in PID reference ramp output.	60.0 s
	0.0...1800.0 s	Time-out limit in seconds.	1 = 1 s
82.30	<i>Outlet minimum pressure protection</i>	Enables outlet minimum pressure protection function.	<i>Disabled</i>
	Disabled	Outlet minimum pressure protection function is disabled.	0
	Warning	Outlet minimum pressure protection function generates warning <i>D50E Outlet minimum pressure</i> when the outlet minimum pressure is below the level defined with parameter <i>82.31 Outlet minimum pressure warning level</i> for a time set in <i>82.45 Pressure check delay</i> .	1
	Fault	Outlet minimum pressure protection function generates fault <i>D408 Outlet minimum pressure</i> when the outlet minimum pressure is below the level defined with parameter <i>82.32 Outlet minimum pressure fault level</i> for a time set in parameter <i>82.45 Pressure check delay</i> .	2
	Warning/Fault	Outlet minimum pressure protection function first generates a warning when the pressure is below the level defined with parameter <i>82.31 Outlet minimum pressure warning level</i> for a time set in parameter <i>82.45 Pressure check delay</i> . If the pressure continues to fall below the level defined with parameter <i>82.32 Outlet minimum pressure fault level</i> , outlet minimum pressure fault is generated.	3

No.	Name/Value	Description	Def/FbEq16
82.31	<i>Outlet minimum pressure warning level</i>	Defines the level at which drive should generate the outlet minimum pressure warning.	0.00 bar
	0.00...32767.00 bar	Outlet minimum pressure warning level.	1 = 1 bar
82.32	<i>Outlet minimum pressure fault level</i>	Defines the level at which drive should generate the outlet minimum pressure fault.	0.00 bar
	0.00...32767.00 bar	Outlet minimum pressure fault level.	1 = 1 bar
82.35	<i>Outlet maximum pressure protection</i>	Enables outlet maximum pressure protection function.	<i>Disabled</i>
	Disabled	Outlet maximum pressure protection is disabled.	0
	Warning	Outlet maximum pressure protection function generates warning <i>D50F Outlet maximum pressure</i> when the pressure is above the level defined with parameter <i>82.37 Outlet maximum pressure warning level</i> for a time set in parameter <i>82.45 Pressure check delay</i> .	1
	Fault	Outlet maximum pressure protection function generates fault <i>D409 Outlet maximum pressure</i> when the pressure is above the level defined with parameter <i>82.38 Outlet maximum pressure fault level</i> for a time set in parameter <i>82.45 Pressure check delay</i> .	2
	Warning/Fault	Outlet maximum pressure protection function first generates a warning when the pressure is above the level defined with parameter <i>82.37 Outlet maximum pressure warning level</i> for a time set in parameter <i>82.45 Pressure check delay</i> . If the pressure raises above the level defined with parameter <i>82.38 Outlet maximum pressure fault level</i> , outlet maximum pressure fault is generated.	3
82.37	<i>Outlet maximum pressure warning level</i>	Defines the level at which drive should generate the outlet maximum pressure warning.	0.00 bar
	0.00...32767.00 bar	Outlet maximum pressure warning level.	1 = 1 bar
82.38	<i>Outlet maximum pressure fault level</i>	Defines the level at which drive should generate the outlet maximum pressure fault.	0.00 bar
	0.00...32767.00 bar	Outlet maximum pressure fault level.	1 = 1 bar
82.40	<i>Inlet minimum pressure protection</i>	Enables inlet minimum pressure protection function.	<i>Disabled</i>
	Disabled	Inlet minimum pressure protection is disabled.	0
	Warning	Inlet minimum pressure protection function generates warning <i>D510 Inlet minimum pressure</i> when the pressure is below the level defined with parameter <i>82.41 Inlet minimum pressure warning level</i> for a time set in <i>82.45 Pressure check delay</i> .	1
	Fault	Inlet minimum pressure protection function generates fault <i>D40A Inlet minimum pressure</i> when the pressure is below the level defined with parameter <i>82.42 Inlet minimum pressure fault level</i> for a time set in <i>82.45 Pressure check delay</i> .	2
	Warning/Fault	Inlet minimum pressure protection function first generates a warning when the pressure is below the level defined with parameter <i>82.41 Inlet minimum pressure warning level</i> for a time set in <i>82.45 Pressure check delay</i> . If the pressure continues to fall below the level defined with parameter <i>82.42 Inlet minimum pressure fault level</i> , a fault is generated.	3

No.	Name/Value	Description	Def/FbEq16
82.41	<i>Inlet minimum pressure warning level</i>	Defines the level at which drive should generate the inlet minimum pressure warning.	0.00 bar
	0.00...32767.00 bar	Inlet minimum pressure warning level.	1 = 1 bar
82.42	<i>Inlet minimum pressure fault level</i>	Defines the level at which drive should generate the inlet minimum pressure fault.	0.00 bar
	0.00...32767.00 bar	Inlet minimum pressure fault level.	1 = 1 bar
82.45	<i>Pressure check delay</i>	Defines the delay time at which the pressure supervisions are inactive. You can adjust check delay for a system in which the pressure does not increase immediately after starting the motor.	3.00 s
	0.00...3600.00 s	Pressure check delay time.	1 = 1 s

83 Pump cleaning		Settings for the pump cleaning sequence. See section <i>Pump cleaning</i> (page 124).	
83.01	<i>Pump cleaning status</i>	Displays the status of pump cleaning.	-
	Disabled	Cleaning sequence is disabled.	0
	Pump clean	Cleaning sequence is active.	1
	No triggers configured	Triggers are not configured.	2
	Waiting for triggering	Waiting for triggering signal.	3
	Triggered	Cleaning sequence is triggered by parameter 83.11 specifies warning generation only.	4
83.02	<i>Pump cleaning progress</i>	Displays the pump cleaning progress.	-
	0...100%	Percentage	10 = 1%
83.03	<i>Total cleaning count</i>	Displays the total cleaning count.	-
	0...4294967295	Total cleaning count.	
83.10	<i>Pump cleaning action</i>	Enables the pump cleaning action.	<i>Cleaning</i>
	Off	Pump cleaning is disabled.	0
	Cleaning	Pump cleaning is started based on triggers.	1
	Warning only	Generates warning message based on triggers.	2

No.	Name/Value	Description	Def/FbEq16																																																
83.11	<i>Pump cleaning triggers</i>	Enables/disables the pump cleaning sequence for the drive, and defines the triggering conditions. Note: If DI1 remains On after cleaning is finished, no cleaning sequence is started. The drive starts cleaning on next start, if the trigger signal is On when motor is started.	0b0000																																																
<table border="1"> <thead> <tr> <th>Bit</th> <th>Name</th> <th>Description</th> </tr> </thead> <tbody> <tr> <td>0</td> <td>Reserved</td> <td></td> </tr> <tr> <td>1</td> <td>Every start</td> <td>Cleaning starts at every start.</td> </tr> <tr> <td>2</td> <td>Every stop</td> <td>Cleaning starts at every stop.</td> </tr> <tr> <td>3</td> <td>Reserved</td> <td></td> </tr> <tr> <td>4</td> <td>Overload detection</td> <td>Cleaning sequence starts when overload situation is detected. To set up the overload curve, see parameters in group 37 User load curve.</td> </tr> <tr> <td>5</td> <td>Underload detection</td> <td>Cleaning sequence starts when underload situation is detected. To set up the overload curve, see parameters in group 37 User load curve.</td> </tr> <tr> <td>6</td> <td>Fixed time interval</td> <td>Time interval defined by parameter 83.15 Fixed time interval.</td> </tr> <tr> <td>7</td> <td>Combined timer1</td> <td>Combined timer 1 of timed functions starts cleaning.</td> </tr> <tr> <td>8...9</td> <td>Reserved</td> <td></td> </tr> <tr> <td>10</td> <td>Supervision 1</td> <td>Cleaning sequence starts when Supervision 1 is high.</td> </tr> <tr> <td>11</td> <td>Supervision 2</td> <td>Cleaning sequence starts when Supervision 2 is high.</td> </tr> <tr> <td>12</td> <td>Supervision 3</td> <td>Cleaning sequence starts when Supervision 3 is high.</td> </tr> <tr> <td>13</td> <td>DI4</td> <td>Cleaning sequence starts when DI4 is high.</td> </tr> <tr> <td>14</td> <td>DI5</td> <td>Cleaning sequence starts when DI5 is high.</td> </tr> <tr> <td>15</td> <td>DI6</td> <td>Cleaning sequence starts when DI6 is high.</td> </tr> </tbody> </table>				Bit	Name	Description	0	Reserved		1	Every start	Cleaning starts at every start.	2	Every stop	Cleaning starts at every stop.	3	Reserved		4	Overload detection	Cleaning sequence starts when overload situation is detected. To set up the overload curve, see parameters in group 37 User load curve .	5	Underload detection	Cleaning sequence starts when underload situation is detected. To set up the overload curve, see parameters in group 37 User load curve .	6	Fixed time interval	Time interval defined by parameter 83.15 Fixed time interval .	7	Combined timer1	Combined timer 1 of timed functions starts cleaning.	8...9	Reserved		10	Supervision 1	Cleaning sequence starts when Supervision 1 is high.	11	Supervision 2	Cleaning sequence starts when Supervision 2 is high.	12	Supervision 3	Cleaning sequence starts when Supervision 3 is high.	13	DI4	Cleaning sequence starts when DI4 is high.	14	DI5	Cleaning sequence starts when DI5 is high.	15	DI6	Cleaning sequence starts when DI6 is high.
Bit	Name	Description																																																	
0	Reserved																																																		
1	Every start	Cleaning starts at every start.																																																	
2	Every stop	Cleaning starts at every stop.																																																	
3	Reserved																																																		
4	Overload detection	Cleaning sequence starts when overload situation is detected. To set up the overload curve, see parameters in group 37 User load curve .																																																	
5	Underload detection	Cleaning sequence starts when underload situation is detected. To set up the overload curve, see parameters in group 37 User load curve .																																																	
6	Fixed time interval	Time interval defined by parameter 83.15 Fixed time interval .																																																	
7	Combined timer1	Combined timer 1 of timed functions starts cleaning.																																																	
8...9	Reserved																																																		
10	Supervision 1	Cleaning sequence starts when Supervision 1 is high.																																																	
11	Supervision 2	Cleaning sequence starts when Supervision 2 is high.																																																	
12	Supervision 3	Cleaning sequence starts when Supervision 3 is high.																																																	
13	DI4	Cleaning sequence starts when DI4 is high.																																																	
14	DI5	Cleaning sequence starts when DI5 is high.																																																	
15	DI6	Cleaning sequence starts when DI6 is high.																																																	
	0000h...FFFFh	Pump cleaning triggers,	1 = 1																																																
83.12	<i>Manually force cleaning</i>	Starts pump cleaning.	<i>Not active</i>																																																
	Not active	Pump cleaning is not active.	0																																																
	Start cleaning now	Starts pump cleaning immediately.	1																																																
	DI4	Starts pump cleaning when DI4 goes high.	2																																																
	DI5	Starts pump cleaning when DI5 goes high.	3																																																
	DI6	Starts pump cleaning when DI6 goes high.	4																																																
	<i>Other [bit]</i>	Source selection (see Terms and abbreviations on page 285).	-																																																
83.15	<i>Fixed time interval</i>	Defines the constant time interval between cleaning cycles. This parameter is used only when cleaning is triggered by time interval.	02 00:00																																																
	00 00:00... 45:12:15	Time interval in format DD HH:MM (day hour:min).	-																																																
83.16	<i>Cycles in cleaning program</i>	Defines the number of cycles performed in cleaning program. For example, 1 cycle = 1 forward + 1 reverse step.	3																																																
	1...65535	Value range.	1 = 1																																																

No.	Name/Value	Description	Def/FbEq16
83.20	<i>Cleaning speed step</i>	Defines the speed/frequency step size in pump cleaning. Cleaning speed step is same for positive and negative directions. Note: If you have disabled the negative rotation direction by speed limits, the pump cleaning does not operate in the negative direction.	80%
	0...100%	Percentage of the cleaning speed/frequency value.	1 = 1%
83.25	<i>Time to cleaning speed</i>	Defines the time required for the drive to reach cleaning speed set by parameter <i>83.20 Cleaning speed step</i> .	3.000 s
	0.000...60.000 s	Time.	1 = 1 s
83.26	<i>Time to zero-speed</i>	Defines the time required for the drive to reach zero speed from the cleaning speed set by parameter <i>83.20 Cleaning speed step</i> .	3.000 s
	0.000...60.000 s	Time	1 = 1 s
83.27	<i>Cleaning on time</i>	Defines the cleaning On time when the drive is running at cleaning speed set by parameter <i>83.20 Cleaning speed step</i> .	10.000 s
	0.000...1000.000 s	Time.	1 = 1 s
83.28	<i>Cleaning off time</i>	Defines the cleaning Off time when the drive stays at zero speed between positive and negative pulses and after one cleaning cycle before starting a new cleaning cycle.	5.000 s
	0.000...1000.000 s	Time.	1 = 1 s
83.35	<i>Cleaning count fault</i>	Activates the cleaning count monitoring, and selects the action it takes if it detects too many cleaning starts within the time defined by parameter <i>83.36 Cleaning count time</i> . See section <i>Cleaning count monitoring</i> (page 126).	<i>No action</i>
	No action	No action.	0
	Warning	Warning.	1
	Fault	Fault.	2
83.36	<i>Cleaning count time</i>	Defines the time for cleaning count monitoring. See section <i>Cleaning count monitoring</i> (page 126).	00 01:00
	00 00:00... 45:12:15	Time.	-
83.37	<i>Maximum cleaning count</i>	Defines the maximum cleaning counts allowed. See section <i>Cleaning count monitoring</i> (page 126).	5
	0...30	Maximum cleaning counts.	1 = 1
94 LSU control			
		Control of the supply unit of the drive, such as DC voltage and reactive power reference. <i>(Only visible for ACQ580-31 and ACQ580-34).</i> Note that the references defined here must also be selected as the reference source in the supply control program to be effective. See also section <i>Control of a line supply unit (LSU)</i> (page 97).	
94.01	<i>LSU control</i>	Enables/disables the internal INU-LSU state machine. When the state machine is enabled, the inverter unit (INU) controls the supply unit (LSU) and prevents the inverter unit from starting until the supply unit is ready. When the state machine is disabled, the status of the supply unit (LSU) is ignored by the inverter unit.	<i>On</i>
	Off	INU-LSU state machine disabled.	0

No.	Name/Value	Description	Def/FbEq16
	On	INU-LSU state machine enabled.	1
94.02	<i>LSU panel communication</i>	Enables/disables control panel and PC tool access to the supply unit (line-side converter) via the inverter unit (motor-side converter). Note: This feature is only supported by ACQ580-31 and ACQ580-34.	<i>Disable</i>
	Disable	Direct control panel and PC tool access to supply unit control board via inverter unit is disabled. Drive acts as single inverter on the panel bus.	0
	Enable	Direct control panel and PC tool access to supply unit control board via inverter unit is enabled. Drive unit shows as two separate units (inverter and supply unit) on the panel bus.	1
94.04	<i>INU-LSU status word profile</i>	Defines INU-LSU status word profile. Note: This feature is only supported by ACQ580-31 and ACQ580-34.	<i>ABB single drives standard SW</i>
	ABB single drives standard SW	Drive indicates Ready run state in <i>06.11 Main status word</i> bit 1 when DC link is charged. This way the drive behaves in a similar way than -01 type drives.	0
	Backwards compatible SW	Drive indicates Ready run state in <i>06.11 Main status word</i> bit 1 after the main contactor is closed and LSU is running.	1
94.10	<i>LSU max charging time</i>	Defines the maximum time the supply unit (LSU) is allowed for charging before fault <i>7584 LSU charge failed</i> is generated.	15 s
	0...65535 s	Maximum charging time.	1 = 1 s
94.11	<i>LSU stop delay</i>	Defines a stop delay for the supply unit. This parameter can be used to delay the opening of the main breaker/contactors when a restart is expected.	600.0 s
	0.0 ... 3600.0 s	Supply unit stop delay.	10 = 1 s
94.22	<i>User DC voltage reference</i>	Defines the DC voltage reference for the supply unit.	0.0 V
	0.0 ... 2000.0 V	User DC reference.	10 = 1 V
94.32	<i>User reactive power reference</i>	Defines the reactive power reference for the supply unit.	0.0 kvar
	-3276.8 ... 3276.7 kvar	User reactive power reference.	10 = 1 kvar
94.40	<i>Power mot limit on net loss</i>	Defines the maximum shaft power for motoring mode upon a supply network failure when IGBT supply unit control is active (bit 15 of <i>95.20 HW options word 1</i> is on). The value is given in percent of nominal motor power.	600.00%
	0.00 ... 600.00%	Maximum shaft power for motoring mode upon a supply network failure.	1 = 1%
94.41	<i>Power gen limit on net loss</i>	Defines the maximum shaft power for generating upon a supply network failure when supply unit control is active (bit 15 of <i>95.20 HW options word 1</i> is on). The value is given in percent of nominal motor power.	-600.00%
	-600.00 ... 0.00%	Maximum shaft power for generating mode upon a supply network failure.	1 = 1%

No.	Name/Value	Description	Def/FbEq16
95 HW configuration			
95.01	<i>Supply voltage</i>	<p>Selects the supply voltage range. This parameter is used by the drive to determine the nominal voltage of the supply network. The parameter also affects the current ratings and the DC voltage control functions (trip and brake chopper activation limits) of the drive.</p> <p> WARNING! An incorrect setting may cause the motor to rush uncontrollably, or the brake chopper or resistor to overload.</p> <p>Note: The selections shown depend on the hardware of the drive. If only one voltage range is valid for the drive in question, it is selected by default.</p> <p>Note: In ACQ580-31 and ACQ580-34, you have to select the supply voltage manually as the automatic selection is not supported.</p>	<i>Automatic / not selected</i>
	Automatic / not selected	<p>No voltage range selected. The drive will not start modulating before a range is selected, unless parameter <i>95.02 Adaptive voltage limits</i> is set to <i>Enable</i>, in which case the drive estimates the supply voltage itself.</p> <p>Note: Not supported for ACQ580-31 and ACQ580-34.</p>	0
	208...240 V	208...240 V	1
	380...415 V	380...415 V	2
	440...480 V	440...480 V	3
	525...600 V	525...600 V	5
95.02	<i>Adaptive voltage limits</i>	<p>Enables adaptive voltage limits.</p> <p>Adaptive voltage limits can be used if, for example, an IGBT supply unit is used to raise the DC voltage level. If the communication between the inverter and IGBT supply unit is active, the voltage limits are related to the DC voltage reference from the IGBT supply unit. Otherwise the limits are calculated based on the measured DC voltage at the end of the pre-charging sequence.</p> <p>This function is also useful if the AC supply voltage to the drive is high, as the warning levels are raised accordingly.</p>	<i>Enable</i>
	Disable	Adaptive voltage limits disabled.	0
	Enable	Adaptive voltage limits enabled.	1
95.03	<i>Estimated AC supply voltage</i>	<p>AC supply voltage estimated by calculation. Estimation is done every time the drive is powered up and is based on the rise speed of voltage level of the DC bus while the drive charges the DC bus.</p> <p>Note: This parameter is not used for ACQ580-31 and ACQ580-34. The supply voltage is shown by parameter <i>01.109 Grid voltage</i>.</p>	-
	0...65535 V	Voltage.	10 = 1 V
95.04	<i>Control board supply</i>	Specifies how the control board of the drive is powered.	<i>Internal 24V</i>
	Internal 24V	The drive control board is powered from the drive power unit it is connected to.	0
	External 24V	The drive control board is powered from an external power supply.	1

No.	Name/Value	Description	Def/FbEq16
95.15	<i>Special HW settings</i>	<p>Contains hardware-related settings that can be enabled and disabled by toggling the specific bits.</p> <p>Notes:</p> <ul style="list-style-type: none"> The installation of the hardware specified by this parameter may require derating of drive output, or impose other limitations. See (ATEX) the <i>Hardware manual</i> of the drive. With the CPTC-02 ATEX-certified thermistor protection module, follow the instructions given in the <i>CPTC-02 ATEX-certified thermistor protection module, Ex II (2) GD (+L537+Q971) user's manual</i> (3AXD50000030058 [English]). 	0000h

Bit	Name	Information
0	EX motor	<p>1 = The driven motor is an Ex (ATEX) motor provided by ABB for potentially explosive atmospheres. This sets the required minimum switching frequency for ABB Ex (ATEX) motors.</p> <p>Notes:</p> <ul style="list-style-type: none"> For non-ABB Ex (ATEX) motors, use parameters 97.01 and 97.02 to define the correct minimum switching frequency. If you have a multimotor system, contact your local ABB representative.
1	ABB Sine filter	1 = An ABB sine filter is connected to the output of the drive.
2...15	Reserved	

0000h...FFFFh	Hardware options configuration word.	1 = 1	
95.20	<i>HW options word 1</i>	<p>Specifies hardware-related options that require differentiated parameter defaults.</p> <p>This parameter is not affected by a parameter restore.</p>	-

Bit	Name	Value
0	Supply frequency 60 Hz	<p>See section Differences in the default values between 50 Hz and 60 Hz supply frequency settings on page 540.</p> <p>0 = 50 Hz. 1 = 60 Hz.</p>
1...12	Reserved	
13	du/dt filter activation	<p>When active, an external du/dt filter is connected to the drive/inverter output. The setting will limit the output switching frequency, and force the fan of the drive/inverter module to full speed.</p> <p>0 = du/dt filter inactive. 1 = du/dt filter active.</p>
14	Reserved	
15	INU-ISU communication	*1 = IGBT supply unit control by inverter unit active. Makes several parameters visible in groups 01 , 05 , 06 , 07 , 30 , 31 , 60 , 61 , 62 , 94 and 96 .

*See section [Control of a line supply unit \(LSU\)](#) (page 97).

0000h...FFFFh	Hardware options configuration word.	1 = 1
---------------	--------------------------------------	-------

No.	Name/Value	Description	Def/FbEq16															
95.21	<i>HW options word 2</i>	<p>Specifies more hardware-related options that require differentiated parameter defaults. See parameter 95.20 HW options word 1.</p> <p> WARNING! After switching any bits in this word, recheck the values of the affected parameters.</p>	-															
<table border="1"> <thead> <tr> <th>Bit</th> <th>Name</th> <th>Information</th> </tr> </thead> <tbody> <tr> <td>0...5</td> <td>Reserved</td> <td></td> </tr> <tr> <td>6</td> <td>Cabinet drive</td> <td>0 = Inactive, 1 = Active. Only for drive frames R6 or larger.</td> </tr> <tr> <td>7</td> <td>Cabinet fan</td> <td>0 = Inactive, 1 = Active. Only for drive frames R6 or larger.</td> </tr> <tr> <td>8...15</td> <td>Reserved</td> <td></td> </tr> </tbody> </table>				Bit	Name	Information	0...5	Reserved		6	Cabinet drive	0 = Inactive, 1 = Active. Only for drive frames R6 or larger.	7	Cabinet fan	0 = Inactive, 1 = Active. Only for drive frames R6 or larger.	8...15	Reserved	
Bit	Name	Information																
0...5	Reserved																	
6	Cabinet drive	0 = Inactive, 1 = Active. Only for drive frames R6 or larger.																
7	Cabinet fan	0 = Inactive, 1 = Active. Only for drive frames R6 or larger.																
8...15	Reserved																	
	0000b...0101b	Hardware options configuration word 2.	1 = 1															
95.26	<i>Motor disconnect detection</i>	<p>Detects if motor is disconnected and shows a warning of disconnected motor.</p> <p>When this parameter is enabled, the drive will do the following:</p> <ol style="list-style-type: none"> 1. The drive detects if the motor is disconnected from the drive (all three phases). 2. When a motor disconnection is detected, the drive will stay running and waits for the motor to be connected again. The drive shows warning A784 Motor disconnect on the control panel. 3. When motor connection is again detected, the motor returns back to the last active reference before the disconnection was detected. 4. The warning message disappears from the panel. <p>Note: This feature is only available in scalar control mode. This parameter does not affect vector control mode behavior.</p>	<i>Disable</i>															
	Disable	Detecting of disconnecting motor disabled.	0															
	Enable	Detecting of disconnecting motor enabled.	1															
95.200	<i>Cooling fan mode</i>	Cooling fan operation mode.	<i>Auto</i>															
	Auto	Fan runs normally: Fan on/off, fan speed reference can autochange according to the drive state.	0															
	Always on	Fan always runs at 100% speed reference.	1															

No.	Name/Value	Description	Def/FbEq16																																																																																								
96 System		Language selection; access levels; macro selection; parameter save and restore; control unit reboot; user parameter sets; unit selection; parameter checksum calculation; user lock.																																																																																									
96.01	<i>Language</i>	<p>Selects the language of the parameter interface and other displayed information when viewed on the control panel.</p> <p>Drive supports multiple languages. The languages are divided in three firmware packages: Global, European and Asian.</p> <p>The default package is Global package that supports languages marked with X and G. European delta supports languages marked with X and E. Asian delta supports languages marked with X and A.</p> <table border="1" data-bbox="339 512 848 1123"> <thead> <tr> <th>Language</th> <th>Global package</th> <th>European</th> <th>Asian</th> </tr> </thead> <tbody> <tr><td>English</td><td>X</td><td>X</td><td>X</td></tr> <tr><td>German</td><td>X</td><td>X</td><td>X</td></tr> <tr><td>Spanish</td><td>X</td><td>X</td><td>X</td></tr> <tr><td>Portuguese</td><td>X</td><td>X</td><td>X</td></tr> <tr><td>French</td><td>X</td><td>X</td><td>X</td></tr> <tr><td>Chinese (Simplified)</td><td>X</td><td></td><td>X</td></tr> <tr><td>Italian</td><td>G</td><td></td><td></td></tr> <tr><td>Finnish</td><td>G</td><td></td><td></td></tr> <tr><td>Polish</td><td>G</td><td></td><td></td></tr> <tr><td>Russian</td><td>G</td><td></td><td></td></tr> <tr><td>Turkish</td><td>G</td><td></td><td></td></tr> <tr><td>Dutch</td><td></td><td>E</td><td></td></tr> <tr><td>Danish</td><td></td><td>E</td><td></td></tr> <tr><td>Swedish</td><td></td><td>E</td><td></td></tr> <tr><td>Czech</td><td></td><td>E</td><td></td></tr> <tr><td>Greek (Ellinika)</td><td></td><td>E</td><td></td></tr> <tr><td>Hungarian (Magyar)</td><td></td><td>E</td><td></td></tr> <tr><td>Hebrew</td><td></td><td>(E)</td><td></td></tr> <tr><td>Korean</td><td></td><td></td><td>A</td></tr> <tr><td>Japanese</td><td></td><td></td><td>A</td></tr> <tr><td>Thai</td><td></td><td></td><td>A</td></tr> </tbody> </table> <p>X = Common language, available in all packages G = Available in Global package only E = Available in European package only (E) = Will be available later A = Available in Asian package only</p>	Language	Global package	European	Asian	English	X	X	X	German	X	X	X	Spanish	X	X	X	Portuguese	X	X	X	French	X	X	X	Chinese (Simplified)	X		X	Italian	G			Finnish	G			Polish	G			Russian	G			Turkish	G			Dutch		E		Danish		E		Swedish		E		Czech		E		Greek (Ellinika)		E		Hungarian (Magyar)		E		Hebrew		(E)		Korean			A	Japanese			A	Thai			A	<i>English</i>
Language	Global package	European	Asian																																																																																								
English	X	X	X																																																																																								
German	X	X	X																																																																																								
Spanish	X	X	X																																																																																								
Portuguese	X	X	X																																																																																								
French	X	X	X																																																																																								
Chinese (Simplified)	X		X																																																																																								
Italian	G																																																																																										
Finnish	G																																																																																										
Polish	G																																																																																										
Russian	G																																																																																										
Turkish	G																																																																																										
Dutch		E																																																																																									
Danish		E																																																																																									
Swedish		E																																																																																									
Czech		E																																																																																									
Greek (Ellinika)		E																																																																																									
Hungarian (Magyar)		E																																																																																									
Hebrew		(E)																																																																																									
Korean			A																																																																																								
Japanese			A																																																																																								
Thai			A																																																																																								

No.	Name/Value	Description	Def/FbEq16
		<p>The drives include the language package corresponding to the order's geographical location. No plus code or other actions are needed.</p> <p>Examples:</p> <ul style="list-style-type: none"> • If the order is placed in Sweden, the drives will be delivered with the Global package (default package). • If the order is placed in Greece, the drives will be updated with European package before the delivery. • If the order is placed in Japan, the drives will be updated with Asian package before the delivery. <p>All the language package variants are available from your local drives support.</p> <p>Notes:</p> <ul style="list-style-type: none"> • Not all languages listed below are necessarily supported. • This parameter does not affect the languages visible in the Drive composer PC tool. (Those are specified under View > Settings > Drive default language.) 	
	Not selected	None.	0
	English	English. Included in all packages.	1033
	Deutsch	German. Included in all packages.	1031
	Italiano	Italian. Included in Global package.	1040
	Español	Spanish. Included in all packages.	3082
	Portugues	Portuguese. Included in all packages.	2070
	Nederlands	Dutch. Included in European package.	1043
	Français	French. Included in all packages.	1036
	Dansk	Danish. Included in European package.	1030
	Suomi	Finnish. Included in Global package.	1035
	Svenska	Swedish. Included in European package.	1053
	Russki	Russian. Included in Global package.	1049
	Polski	Polish. Included in Global package.	1045
	Türkçe	Turkish. Included in Global package.	1055
	Chinese (Simplified, PRC)	Simplified Chinese. Included in Global and Asian packages.	2052
	Ceský	Czech. Included in European package.	1029
	Greek	Greek. Included in European package.	1032
	Magyar	Hungarian. Included in European package.	1038
	Korean	Korean. Included in Asian package.	1042
	Japanese	Japanese. Included in Asian package.	1041
	Thai	Thai. Included in Asian package.	1054

No.	Name/Value	Description	Def/FbEq16																				
96.02	<i>Pass code</i>	<p>Pass codes can be entered into this parameter to activate further access levels (see parameter 96.03 Access level status) or to configure the user lock.</p> <p>Entering "358" toggles the parameter lock, which prevents the changing of all other parameters through the control panel or the Drive composer PC tool.</p> <p>Entering the user pass code (by default, "10000000") enables parameters 96.100...96.102, which can be used to define a new user pass code and to select the actions that are to be prevented.</p> <p>Entering an invalid pass code will close the user lock if open, ie, hide parameters 96.100...96.102. After entering the code, check that the parameters are in fact hidden. If they are not, enter another (random) pass code.</p> <p>Note: You must change the default user pass code to maintain a high level of cybersecurity. <u>Store the code in a safe place – ABB CANNOT UNLOCK THE DRIVE ONCE YOU CHANGE THE PASS CODE.</u></p> <p>See also section User lock (page 184).</p>																					
	0...99999999	Pass code.	-																				
96.03	<i>Access level status</i>	Shows which access levels have been activated by pass codes entered into parameter 96.02 Pass code .	0001b																				
		<table border="1"> <thead> <tr> <th>Bit</th> <th>Name</th> </tr> </thead> <tbody> <tr> <td>0</td> <td>End user</td> </tr> <tr> <td>1</td> <td>Service</td> </tr> <tr> <td>2</td> <td>Advanced programmer</td> </tr> <tr> <td>3...10</td> <td>Reserved</td> </tr> <tr> <td>11</td> <td>OEM access level 1</td> </tr> <tr> <td>12</td> <td>OEM access level 2</td> </tr> <tr> <td>13</td> <td>OEM access level 3</td> </tr> <tr> <td>14</td> <td>Parameter lock</td> </tr> <tr> <td>15</td> <td>Reserved</td> </tr> </tbody> </table>	Bit	Name	0	End user	1	Service	2	Advanced programmer	3...10	Reserved	11	OEM access level 1	12	OEM access level 2	13	OEM access level 3	14	Parameter lock	15	Reserved	
Bit	Name																						
0	End user																						
1	Service																						
2	Advanced programmer																						
3...10	Reserved																						
11	OEM access level 1																						
12	OEM access level 2																						
13	OEM access level 3																						
14	Parameter lock																						
15	Reserved																						
	0000h...FFFFh	Active access levels.	1 = 1																				
96.04	<i>Macro select</i>	<p>Selects the control macro. See chapter Default I/O configuration (page 83) for more information.</p> <p>After a selection is made, the parameter reverts automatically to <i>Done</i>.</p>	<i>Done</i>																				
	Done	Macro selection complete; normal operation.	0																				
	Water default	Factory default (page 84). For scalar motor control.	1																				
96.05	<i>Macro active</i>	<p>Shows which control macro is currently selected. See chapter Default I/O configuration (page 83) for more information.</p> <p>To change the macro, use parameter 96.04 Macro select.</p>	<i>Water default</i>																				
	Water default	Factory default (page 84). For scalar motor control.	1																				
96.06	<i>Parameter restore</i>	<p>Restores the original settings of the control program, ie, parameter default values.</p> <p>Note: This parameter cannot be changed while the drive is running.</p>	<i>Done</i>																				
	Done	Restoring is completed.	0																				

No.	Name/Value	Description	Def/FbEq16
	Restore defaults	Restores all editable parameter values to default values, except <ul style="list-style-type: none"> • motor data and ID run results • I/O extension module settings • end user texts, such as customized warnings and faults, and the drive name • control panel/PC communication settings • fieldbus adapter settings • control macro selection and the parameter defaults implemented by it • parameter 95.01 Supply voltage • differentiated defaults implemented by parameters 95.20 HW options word 1 and 95.21 HW options word 2 • user lock configuration parameters 96.100...96.102. 	8
	Clear all	Restores all editable parameter values to default values, except <ul style="list-style-type: none"> • end user texts, such as customized warnings and faults, and the drive name • control panel/PC communication settings • parameter 95.01 Supply voltage • differentiated defaults implemented by parameters 95.20 HW options word 1 and 95.21 HW options word 2 • user lock configuration parameters 96.100...96.102. • group 49 Panel port communication parameters. 	62
	Reset all fieldbus settings	Restores all fieldbus and communication related settings to default values. Note: Fieldbus, control panel and PC tool communication are interrupted during the restore.	32
	Reset home view	Restores the home view layout back to show the values of the default parameters defined by the control macro in use	512
	Reset end user texts	Restores all end user texts to default values, including the drive name, contact info, customized fault and warning texts, PID unit and currency unit. Note: PID unit is reset only if it is user editable text, that is, parameter 40.79 Set 1 units is set to User text .	1024
	Reset motor data	Restores all motor nominal values and motor ID run results to default values.	2
	All to factory defaults	Restores settings and all editable parameters back to initial factory values, except <ul style="list-style-type: none"> • differentiated defaults implemented by parameters 95.20 HW options word 1 and 95.21 HW options word 2. 	34560
96.07	Parameter save manually	Saves the valid parameter values to the permanent memory on the drive control unit to ensure that operation can continue after cycling the power. Save the parameters with this parameter <ul style="list-style-type: none"> • to store values sent from the fieldbus • when using external +24 V DC power supply to the control unit: to save parameter changes before you power down the control unit. The supply has a very short hold-up time when powered off. Note: A new parameter value is saved automatically when changed from the PC tool or control panel but not when altered through a fieldbus adapter connection.	Done
	Done	Save completed.	0
	Save	Save in progress.	1

No.	Name/Value	Description	Def/FbEq16
96.08	<i>Control board boot</i>	Changing the value of this parameter to 1 reboots the control unit (without requiring a power off/on cycle of the complete drive module). The value reverts to 0 automatically.	<i>No action</i>
	No action	1 = No action.	0
	Reboot	1 = Reboot the control unit.	1
96.10	<i>User set status</i>	Shows the status of the user parameter sets. This parameter is read-only. See also section Data storage parameters (page 183).	-
	n/a	No user parameter sets have been saved.	0
	Loading	A user set is being loaded.	1
	Saving	A user set is being saved.	2
	Faulted	Invalid or empty parameter set.	3
	User1 IO active	User set 1 has been selected by parameters 96.12 User set I/O mode in1 and 96.13 User set I/O mode in2 .	4
	User2 IO active	User set 2 has been selected by parameters 96.12 User set I/O mode in1 and 96.13 User set I/O mode in2 .	5
	User3 IO active	User set 3 has been selected by parameters 96.12 User set I/O mode in1 and 96.13 User set I/O mode in2 .	6
	User4 IO active	User set 4 has been selected by parameters 96.12 User set I/O mode in1 and 96.13 User set I/O mode in2 .	7
	Reserved		8...19
	User1 backup	User set 1 has been saved or loaded.	20
	User2 backup	User set 2 has been saved or loaded.	21
	User3 backup	User set 3 has been saved or loaded.	22
	User4 backup	User set 4 has been saved or loaded.	23
96.11	<i>User set save/load</i>	Enables the saving and restoring of up to four custom sets of parameter settings. See section User parameter sets (page 177). The set that was in use before powering down the drive is in use after the next power-up. Notes: <ul style="list-style-type: none"> Hardware configuration settings, such as I/O extension module and fieldbus configuration parameters (groups 14...16, 47, 51...58 and 92...93, and parameter 50.01 FBA A enable), and forced input/output values (such as 10.03 DI force selection and 10.04 DI forced data) are not included in user parameter sets. Parameter changes made after loading a set are not automatically stored – they must be saved using this parameter. If no sets have been saved, attempting to load a set will create all sets from the currently active parameter settings. Switching between sets is only possible with the drive stopped. 	<i>No action</i>
	No action	Load or save operation complete; normal operation.	0
	User set I/O mode	Load user parameter set using parameters 96.12 User set I/O mode in1 and 96.13 User set I/O mode in2 .	1
	Load set 1	Load user parameter set 1.	2
	Load set 2	Load user parameter set 2.	3

No.	Name/Value	Description	Def/FbEq16															
	Load set 3	Load user parameter set 3.	4															
	Load set 4	Load user parameter set 4.	5															
	Reserved		6...17															
	Save to set 1	Save user parameter set 1.	18															
	Save to set 2	Save user parameter set 2.	19															
	Save to set 3	Save user parameter set 3.	20															
	Save to set 4	Save user parameter set 4.	21															
96.12	<i>User set I/O mode in1</i>	When parameter 96.11 <i>User set save/load</i> is set to <i>User set I/O mode</i> , selects the user parameter set together with parameter 96.13 <i>User set I/O mode in2</i> as follows:	<i>Not selected</i>															
		<table border="1"> <thead> <tr> <th>Status of source defined by par. 96.12</th> <th>Status of source defined by par. 96.13</th> <th>User parameter set selected</th> </tr> </thead> <tbody> <tr> <td>0</td> <td>0</td> <td>Set 1</td> </tr> <tr> <td>1</td> <td>0</td> <td>Set 2</td> </tr> <tr> <td>0</td> <td>1</td> <td>Set 3</td> </tr> <tr> <td>1</td> <td>1</td> <td>Set 4</td> </tr> </tbody> </table>	Status of source defined by par. 96.12	Status of source defined by par. 96.13	User parameter set selected	0	0	Set 1	1	0	Set 2	0	1	Set 3	1	1	Set 4	
Status of source defined by par. 96.12	Status of source defined by par. 96.13	User parameter set selected																
0	0	Set 1																
1	0	Set 2																
0	1	Set 3																
1	1	Set 4																
	Not selected	0.	0															
	Selected	1.	1															
	DI1	Digital input DI1 (<i>10.02 DI delayed status</i> , bit 0).	2															
	DI2	Digital input DI2 (<i>10.02 DI delayed status</i> , bit 1).	3															
	DI3	Digital input DI3 (<i>10.02 DI delayed status</i> , bit 2).	4															
	DI4	Digital input DI4 (<i>10.02 DI delayed status</i> , bit 3).	5															
	DI5	Digital input DI5 (<i>10.02 DI delayed status</i> , bit 4).	6															
	DI6	Digital input DI6 (<i>10.02 DI delayed status</i> , bit 5).	7															
	Reserved		8...17															
	Timed function 1	Bit 0 of <i>34.01 Timed functions status</i> (see page 410).	18															
	Timed function 2	Bit 1 of <i>34.01 Timed functions status</i> (see page 410).	19															
	Timed function 3	Bit 2 of <i>34.01 Timed functions status</i> (see page 410).	20															
	Reserved		21...23															
	Supervision 1	Bit 0 of <i>32.01 Supervision status</i> (see page 403).	24															
	Supervision 2	Bit 1 of <i>32.01 Supervision status</i> (see page 403).	25															
	Supervision 3	Bit 2 of <i>32.01 Supervision status</i> (see page 403).	26															
	<i>Other [bit]</i>	Source selection (see <i>Terms and abbreviations</i> on page 285).	-															
96.13	<i>User set I/O mode in2</i>	See parameter 96.12 <i>User set I/O mode in1</i> .	<i>Not selected</i>															

No.	Name/Value	Description	Def/FbEq16																					
96.16	Unit selection	Selects the unit of parameters indicating power, temperature and torque.	0000b																					
		<table border="1"> <thead> <tr> <th>Bit</th> <th>Name</th> <th>Information</th> </tr> </thead> <tbody> <tr> <td>0</td> <td>Power unit</td> <td>0 = kW 1 = hp</td> </tr> <tr> <td>1</td> <td>Reserved</td> <td></td> </tr> <tr> <td>2</td> <td>Temperature unit</td> <td>0 = °C 1 = °F</td> </tr> <tr> <td>3</td> <td>Reserved</td> <td></td> </tr> <tr> <td>4</td> <td>Torque unit</td> <td>0 = Nm (N·m) 1 = lbft (lb-ft)</td> </tr> <tr> <td>5...15</td> <td>Reserved</td> <td></td> </tr> </tbody> </table>	Bit	Name	Information	0	Power unit	0 = kW 1 = hp	1	Reserved		2	Temperature unit	0 = °C 1 = °F	3	Reserved		4	Torque unit	0 = Nm (N·m) 1 = lbft (lb-ft)	5...15	Reserved		
Bit	Name	Information																						
0	Power unit	0 = kW 1 = hp																						
1	Reserved																							
2	Temperature unit	0 = °C 1 = °F																						
3	Reserved																							
4	Torque unit	0 = Nm (N·m) 1 = lbft (lb-ft)																						
5...15	Reserved																							
	0000h...FFFFh	Unit selection word.	1 = 1																					
96.20	Time sync primary source	Defines the first priority external source for synchronization of the drive's time and date.	Panel link																					
	Internal	No external source selected.	0																					
	Reserved		1...2																					
	Fieldbus A	FENA/FPNO can get the time from SNTP server and set it as time for the drive.	3																					
	Reserved		4...5																					
	Embedded FB	The embedded fieldbus interface has no function on ACQ drives.	6																					
	Reserved		7																					
	Panel link	You can set the time using <u>the</u> control panel, or <u>a</u> PC tool connected to the panel <u>link</u> .	8																					
	Ethernet tool link	You can set the time manually using DCP over Ethernet. The time can be set in the same way when you do it with USB and panel.	9																					
96.51	Clear fault and event logger	Clears all events from the drive's fault and event logs. See section Warning/fault history on page 188.	Done																					
	Done	0 = No action	0																					
	Reset	1 = Clear the loggers.	1																					
96.54	Checksum action	Selects how the drive reacts <ul style="list-style-type: none"> when 96.55 Checksum control word, bit 8 = 1 (Approved checksum A): if the parameter checksum 96.68 Actual checksum A does not match 96.71 Approved checksum A, and/or when 96.55 Checksum control word, bit 9 = 1 (Approved checksum B): if the parameter checksum 96.69 Actual checksum B does not match 96.72 Approved checksum B. 	No action																					
	No action	No action taken. (The checksum feature is not in use.)	0																					
	Pure event	Drive generates an event log entry B686 Checksum mismatch .	1																					
	Warning	Drive generates warning A686 Checksum mismatch .	2																					
	Warning and prevent start	Drive generates warning A686 Checksum mismatch . Starting the drive is prevented.	3																					

No.	Name/Value	Description	Def/FbEq16																								
	Fault	Drive trips on fault 6200 Checksum mismatch .	4																								
96.55	Checksum control word	<p>Bits 8...9 select which comparison(s) are made:</p> <ul style="list-style-type: none"> • Bit 8 = 1 (Approved checksum A): 96.68 Actual checksum A is compared to 96.71 Approved checksum A, and/or • Bit 9 = 1 (Approved checksum A): if 96.69 Actual checksum B is compared to 96.72 Approved checksum B. <p>Bits 12...13 select approved (reference) checksum parameter(s) into which the actual checksum(s) from parameter(s) are copied:</p> <ul style="list-style-type: none"> • Bit 12 = 1 (Set approved checksum A): Value of 96.68 Actual checksum A is copied into 96.71 Approved checksum A, and/or • Bit 13 = 1 (Set approved checksum B): Value of 96.69 Actual checksum B copied into 96.72 Approved checksum B. 	0000h																								
<table border="1"> <thead> <tr> <th>Bit</th> <th>Name</th> <th>Description</th> </tr> </thead> <tbody> <tr> <td>0...7</td> <td>Reserved</td> <td></td> </tr> <tr> <td>8</td> <td>Approved checksum A</td> <td>1 = Enabled: Checksum A (96.71) is observed. 0 = Disabled.</td> </tr> <tr> <td>9</td> <td>Approved checksum B</td> <td>1 = Enabled: Checksum B (96.72) is observed. 0 = Disabled.</td> </tr> <tr> <td>10...11</td> <td>Reserved</td> <td></td> </tr> <tr> <td>12</td> <td>Set approved checksum A</td> <td>1 = Set: Copy value of 96.68 into 96.71. 0 = Done (copy has been made).</td> </tr> <tr> <td>13</td> <td>Set approved checksum B</td> <td>1 = Set: Copy value of 96.69 into 96.72. 0 = Done (copy has been made).</td> </tr> <tr> <td>14...15</td> <td>Reserved</td> <td></td> </tr> </tbody> </table>				Bit	Name	Description	0...7	Reserved		8	Approved checksum A	1 = Enabled: Checksum A (96.71) is observed. 0 = Disabled.	9	Approved checksum B	1 = Enabled: Checksum B (96.72) is observed. 0 = Disabled.	10...11	Reserved		12	Set approved checksum A	1 = Set: Copy value of 96.68 into 96.71 . 0 = Done (copy has been made).	13	Set approved checksum B	1 = Set: Copy value of 96.69 into 96.72 . 0 = Done (copy has been made).	14...15	Reserved	
Bit	Name	Description																									
0...7	Reserved																										
8	Approved checksum A	1 = Enabled: Checksum A (96.71) is observed. 0 = Disabled.																									
9	Approved checksum B	1 = Enabled: Checksum B (96.72) is observed. 0 = Disabled.																									
10...11	Reserved																										
12	Set approved checksum A	1 = Set: Copy value of 96.68 into 96.71 . 0 = Done (copy has been made).																									
13	Set approved checksum B	1 = Set: Copy value of 96.69 into 96.72 . 0 = Done (copy has been made).																									
14...15	Reserved																										
	0000h...FFFFh	Checksum control word.	1 = 1																								
96.68	Actual checksum A	<p>Displays the actual parameter configuration checksum. Checksum A calculation does not include</p> <ul style="list-style-type: none"> • fieldbus settings. <p>The parameters included in the calculation are user editable parameters in parameter groups 10...13, 15, 19...25, 28, 30...32, 34...37, 40...41, 43, 45...46, 70...74, 76, 80, 94...99.</p> <p>See also section Parameter checksum calculation (page 183).</p>	-																								
	00000000h...FFFFFFFFh	Actual checksum.	-																								

No.	Name/Value	Description	Def/FbEq16
96.69	<i>Actual checksum B</i>	Displays the actual parameter configuration checksum B. Checksum B calculation does not include <ul style="list-style-type: none"> • fieldbus settings • motor data settings • energy data settings. The parameters included in the calculation are user editable parameters in parameter groups 10...13, 15, 19...25, 28, 30...32, 34, 35...37, 40...41, 43, 46, 70...74, 76, 80, 94...97. See also section <i>Parameter checksum calculation</i> (page 183).	-
	00000000h... FFFFFFFFh	Actual checksum.	-
96.70	<i>Disable adaptive program</i>	Enables/disables the adaptive program (if present). See also section <i>Adaptive programming</i> (page 92).	Yes
	No	Adaptive program enabled.	0
	Yes	Adaptive program disabled.	1
96.71	<i>Approved checksum A</i>	Approved (reference) checksum A.	0h
	00000000h... FFFFFFFFh	Approved checksum A.	-
96.72	<i>Approved checksum B</i>	Approved (reference) checksum B.	0h
	00000000h... FFFFFFFFh	Approved checksum B.	-
96.78	<i>550 Compatibility mode</i>	Enables/disables a Modbus user to access a select set of parameters using legacy register numbering. See the supported parameters in section <i>Parameters supported by Modbus legacy compatibility</i> on page 542. Note: This parameter will be replaced by parameters 96.78 <i>Legacy Modbus mapping</i> and 96.79 <i>Legacy control profile</i> in firmware versions 2.15 or later.	Disabled
	Disabled	Using legacy register numbering disabled.	0
	Enabled	Using legacy register numbering and control profile enabled.	1
	Enabled, DCU profile only	Using legacy control profile enabled. For use with some external option modules, for example, FDNA-01.	2
96.78	<i>Legacy Modbus mapping</i>	Enables a Modbus user to access a select set of parameters using legacy register numbering. See the supported parameters in section <i>Parameters supported by Modbus legacy compatibility</i> on page 542. Parameter 96.78 <i>550 Compatibility mode</i> will be replaced by parameters 96.78 <i>Legacy Modbus mapping</i> and 96.79 <i>Legacy control profile</i> in firmware versions 2.15 or later.	Disable
	Disable	Using legacy register numbering disabled.	0
	Enable	Using legacy register numbering enabled. This selection sets parameter 58.33 <i>Addressing mode</i> to <i>Mode 0</i> . Only 16-bit addressing is used, and only 16-bit data is used for reading and writing. 16-bit values (groups 1...99, indexes 1...99): Register address = 40000 + 100 × parameter group + parameter index. For example, parameter 22.80 would be mapped to register 40000 + 2200 + 80 = 42280.	1

No.	Name/Value	Description	Def/FbEq16
96.79	<i>Legacy control profile</i>	Enables using a legacy control profile. Currently only EFB supports legacy profiles. Note: Parameter 96.78 550 Compatibility mode will be replaced by parameters 96.78 Legacy Modbus mapping and 96.79 Legacy control profile in firmware versions 2.15 or later.	<i>Not selected</i>
	Not selected	EFB: Control profile selected with 58.25 Control profile used.	0
	DCU	Legacy DCU profile used.	1
	ABB drives	ABB drives profile used.	2
	ABB drives limited	Legacy ABB drives limited profile used.	3
96.100	<i>Change user pass code</i>	(Visible when user lock is open) To change the current user pass code, enter a new code into this parameter as well as 96.101 Confirm user pass code . A warning will be active until the new pass code is confirmed. To cancel changing the pass code, close the user lock without confirming. To close the lock, enter an invalid pass code in parameter 96.02 Pass code , activate parameter 96.08 Control board boot , or cycle the power. See also section Parameter checksum calculation (page 183).	10000000
	10000000... 99999999	New user pass code.	-
96.101	<i>Confirm user pass code</i>	(Visible when user lock is open) Confirms the new user pass code entered in 96.100 Change user pass code .	
	10000000... 99999999	Confirmation of new user pass code.	-

No.	Name/Value	Description	Def/FbEq16
96.102	User lock functionality	<p>(Visible when user lock is open)</p> <p>Selects the actions or functionalities to be prevented by the user lock. Parameter 96.03 Access level status shows which access are selected.</p> <p>Notes:</p> <ul style="list-style-type: none"> The changes made take effect only when the user lock is closed. See parameter 96.02 Pass code. We recommend you select all the actions and functionalities unless otherwise required by the application. 	0000h

Bit	Name	Information
0	Disable ABB access levels	1 = ABB access levels (service, advanced programmer, etc.; see 96.03) disabled
1	Freeze parameter lock state	1 = Changing the parameter lock state prevented, ie, pass code 358 has no effect
2	Disable file download	1 = Loading of files to drive prevented. This applies to <ul style="list-style-type: none"> firmware upgrades parameter restore loading an adaptive program changing home view of control panel editing drive texts editing the favorite parameters list on control panel configuration settings made through control panel such as time/date formats and enabling/disabling clock display.
3	Reserved	
4	Disable backups	0 = Backups are enabled. 1 = Backups are disabled.
5...6	Reserved	
7	Disable panel Bluetooth	1 = Bluetooth disabled on ACH-AP-W control panel. If the drive is part of a panel bus, Bluetooth is disabled on all control panels.
8...10	Reserved	
11	Disable OEM access level 1	1 = OEM access level 1 disabled
12	Disable OEM access level 2	1 = OEM access level 2 disabled
13	Disable OEM access level 3	1 = OEM access level 3 disabled
14...15	Reserved	

0000h...FFFFh	Selection of actions to be prevented by user lock.	1 = 1	
96.108	LSU control board boot	<p>(Only visible for ACQ580-31 and ACQ580-34).</p> <p>Changing the value of this parameter to 1 reboots the supply control unit (without requiring a power off/on cycle of the drive system).</p> <p>The value reverts to 0 automatically.</p>	0
0...1	1 = Reboot the supply control unit.	1 = 1	

No.	Name/Value	Description	Def/FbEq16
97 Motor control			
		Switching frequency; slip gain; voltage reserve; flux braking; anti-cogging (signal injection); IR compensation.	
97.01	<i>Switching frequency reference</i>	<p>Defines the switching frequency of the drive that is used as long as the drive stays below the thermal limit. See section Switching frequency on page 152.</p> <p>Higher switching frequency results in lower acoustic motor noise. Lower switching frequency generates less switching losses and reduce EMC emissions.</p> <p>Notes:</p> <ul style="list-style-type: none"> • If you have a multimotor system, contact your local ABB representative. • With the CPTC-02 ATEX-certified thermistor protection module, follow the instructions given in the <i>CPTC-02 ATEX-certified thermistor protection module, Ex II (2) GD (+L537+Q971) user's manual (3AXD50000030058 [English])</i>. • With an ABB EX motor, follow the instructions given in the ABB EX motor documentation. 	4 kHz
	2 kHz	2 kHz.	2
	4 kHz	4 kHz.	4
	8 kHz	8 kHz.	8
	12 kHz	12 kHz.	12
97.02	<i>Minimum switching frequency</i>	<p>Lowest switching frequency value that is allowed. Depends on the frame size.</p> <p>When drive is reaching the thermal limit, it will automatically start to reduce the switching frequency until the minimum allowed value is reached. Once the minimum has been reached, the drive will automatically start limiting the output current to keep the temperature below the thermal limit.</p> <p>Inverter temperature is shown by parameter 05.11 Inverter temperature.</p> <p>Notes:</p> <ul style="list-style-type: none"> • With the CPTC-02 ATEX-certified thermistor protection module, follow the instructions given in the <i>CPTC-02 ATEX-certified thermistor protection module, Ex II (2) GD (+L537+Q971) user's manual (3AXD50000030058 [English])</i>. • With an ABB EX motor, follow the instructions given in the ABB EX motor documentation. 	2 kHz
	1.5 kHz	1.5 kHz. Not for all frame sizes.	1
	2 kHz	2 kHz.	2
	4 kHz	4 kHz.	4
	8 kHz	8 kHz.	8
	12 kHz	12 kHz.	12

No.	Name/Value	Description	Def/FbEq16
97.03	<i>Slip gain</i>	<p>Defines the slip gain which is used to improve the estimated motor slip. 100% means full slip gain; 0% means no slip gain. The default value is 100%. Other values can be used if a static speed error is detected despite having the setting at full slip gain.</p> <p>Example (with nominal load and nominal slip of 40 rpm): A 1000 rpm constant speed reference is given to the drive. Despite having full slip gain (= 100%), a manual tachometer measurement from the motor axis gives a speed value of 998 rpm. The static speed error is 1000 rpm - 998 rpm = 2 rpm. To compensate the error, the slip gain should be increased to 105% (2 rpm / 40 rpm = 5%).</p>	100%
	0...200%	Slip gain.	1 = 1%
97.04	<i>Voltage reserve</i>	<p>Defines the minimum allowed voltage reserve. When the voltage reserve has decreased to the set value, the drive enters the field weakening area.</p> <p>Note: This is an expert level parameter and should not be adjusted without appropriate skill.</p> <p>If the intermediate circuit DC voltage $U_{dc} = 550$ V and the voltage reserve is 5%, the RMS value of the maximum output voltage in steady-state operation is $0.95 \times 550 \text{ V} / \sqrt{2} = 369$ V</p> <p>The dynamic performance of the motor control in the field weakening area can be improved by increasing the voltage reserve value, but the drive enters the field weakening area earlier.</p>	-2%
	-4...50%	Voltage reserve.	1 = 1%
97.05	<i>Flux braking</i>	<p>Defines the level of flux braking power. (Other stopping and braking modes can be configured in parameter group 21 Start/stop mode).</p> <p>Note: This is an expert level parameter and should not be adjusted without appropriate skill.</p>	<i>Disabled</i>
	Disabled	Flux braking is disabled.	0
	Moderate	Flux level is limited during the braking. Deceleration time is longer compared to full braking.	1
	Full	<p>Maximum braking power. Almost all available current is used to convert the mechanical braking energy to thermal energy in the motor.</p> <p> WARNING! Using full flux braking heats up the motor especially in cyclic operation. Make sure that the motor can withstand this if you have a cyclic application.</p>	2
97.08	<i>Optimizer minimum torque</i>	<p>This parameter can be used to improve the control dynamics of a synchronous reluctance motor or a salient permanent magnet synchronous motor.</p> <p>As a rule of thumb, define a level to which the output torque must rise with minimum delay. This will increase the motor current and improve the torque response at low speeds.</p>	0.0%
	0.0 ... 1600.0%	Optimizer torque limit.	10 = 1%

No.	Name/Value	Description	Def/FbEq16
97.10	<i>Signal injection</i>	<p>Enables the anti-cogging function: a high-frequency alternating signal is injected to the motor in the low speed region to improve the stability of torque control. This removes the "cogging" that can sometimes be seen as the rotor passes the motor magnetic poles. Anti-cogging can be enabled with different amplitude levels.</p> <p>Notes:</p> <ul style="list-style-type: none"> • This is an expert level parameter and should not be adjusted without appropriate skill. • Use as low a level as possible that gives satisfactory performance. • Signal injection cannot be applied to asynchronous motors. • For ACQ580-01 frames R6...R9 as well as ACQ580-31 and ACQ580-34 drives. 	<i>Disabled</i>
	Disabled	Anti-cogging disabled.	0
	Enabled (5%)	Anti-cogging enabled with amplitude level of 5%.	1
	Enabled (10%)	Anti-cogging enabled with amplitude level of 10%.	2
	Enabled (15%)	Anti-cogging enabled with amplitude level of 15%.	3
	Enabled (20%)	Anti-cogging enabled with amplitude level of 20%.	4
97.11	<i>TR tuning</i>	<p>Rotor time constant tuning.</p> <p>This parameter can be used to improve torque accuracy in closed-loop control of an induction motor. Normally, the motor identification run provides sufficient torque accuracy, but manual fine-tuning can be applied in exceptionally demanding applications to achieve optimal performance.</p> <p>Note: This is an expert level parameter and should not be adjusted without appropriate skill.</p>	100%
	25...400%	Rotor time constant tuning.	1 = 1%

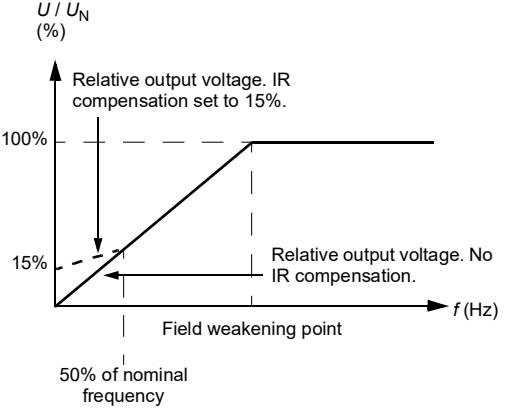
No.	Name/Value	Description	Def/FbEq16																		
97.13	<i>IR compensation</i>	<p>Defines the relative output voltage boost at zero speed (IR compensation). The function is useful in applications with a high break-away torque where vector control cannot be applied.</p>  <p>Typical IR compensation values are shown below.</p> <table border="1" data-bbox="341 726 845 810"> <thead> <tr> <th colspan="6">3-phase $U_N = 400\text{ V}$ (380...415 V) drives</th> </tr> <tr> <th>P_N (kW)</th> <td>3</td> <td>7.5</td> <td>15</td> <td>37</td> <td>132</td> </tr> <tr> <th>IR compensation (%)</th> <td>2.3</td> <td>1.7</td> <td>1.3</td> <td>1.1</td> <td>0.6</td> </tr> </thead> </table> <p>See also section <i>IR compensation for scalar motor control</i> on page 145.</p>	3-phase $U_N = 400\text{ V}$ (380...415 V) drives						P_N (kW)	3	7.5	15	37	132	IR compensation (%)	2.3	1.7	1.3	1.1	0.6	Type specific (%)
3-phase $U_N = 400\text{ V}$ (380...415 V) drives																					
P_N (kW)	3	7.5	15	37	132																
IR compensation (%)	2.3	1.7	1.3	1.1	0.6																
	0.00...50.00%	Voltage boost at zero speed in percent of nominal motor voltage.	1 = 1%																		
97.15	<i>Motor model temperature adaptation</i>	Enables the motor model temperature adaptation. Estimated motor temperature can be used to adapt temperature dependent parameters (for example, resistances) of motor model.	<i>Disabled</i>																		
	Disabled	Temperature adaptation disabled.	0																		
	Estimated temperature	Temperature adaptation with motor temperature estimate (parameter <i>35.01 Motor estimated temperature</i>).	1																		
97.16	<i>Stator temperature factor</i>	Tunes the motor temperature dependence of stator parameters (stator resistance).	50%																		
	0...200%	Tuning factor.	1 = 1%																		
97.17	<i>Rotor temperature factor</i>	Tunes the motor temperature dependence of rotor parameters (eg. rotor resistance).	100%																		
	0...200%	Tuning factor.	1 = 1%																		

No.	Name/Value	Description	Def/FbEq16
97.20	<i>U/F ratio</i>	Selects the form for the <i>U/f</i> (voltage to frequency) ratio below field weakening point. For scalar control only. Notes: <ul style="list-style-type: none"> The <i>U/f</i> function cannot be used with energy optimization; if 45.11 <i>Energy optimizer</i> is set to <i>Enable</i>, parameter 97.20 <i>U/F ratio</i> is ignored. With the CPTC-02 ATEX-certified thermistor protection module, follow the instructions given in the <i>CPTC-02 ATEX-certified thermistor protection module, Ex II (2) GD (+L537+Q971) user's manual (3AXD50000030058 [English])</i>. 	<i>Squared</i>
	Linear	Linear ratio for constant torque applications.	0
	Squared	Squared ratio for centrifugal pump and fan applications. With squared <i>U/f</i> ratio the noise level is lower for most operating frequencies. Not recommended for permanent magnet motors.	1
97.48	<i>UDC stabilizer</i>	<u>Enables or disables the DC bus voltage stabilizer.</u>	<i>Disabled</i>
	Disabled	DC bus voltage stabilizer disabled.	0
	Enabled min	DC bus voltage stabilizer enabled, minimum stabilization.	50
	Enabled mild	DC bus voltage stabilizer enabled, mild stabilization.	100
	Enabled medium	DC bus voltage stabilizer enabled, medium stabilization.	300
	Enabled strong	DC bus voltage stabilizer enabled, strong stabilization.	500
	Enabled max	DC bus voltage stabilizer enabled, maximum stabilization.	800
97.49	<i>Slip gain for scalar</i>	Sets gain for slip compensation in percent when the drive is operating in scalar control mode. A squirrel-cage motor slips under load. Increasing the frequency as the motor torque increases compensates for the slip. Note: This parameter is only effective in scalar motor control mode (parameter 99.04 <i>Motor control mode</i> is set to <i>Scalar</i>).	0%
	0...200%	0% = No slip compensation. 0...200% = Increasing slip compensation. 100% means full slip compensation according to parameter 99.08 <i>Motor nominal frequency</i> and 99.09 <i>Motor nominal speed</i> .	1 = 1%
97.94	<i>IR comp max frequency</i>	Sets the frequency at which IR compensation set by parameter 97.13 <i>IR compensation</i> reaches 0 V. Unit is percent of the motor nominal frequency.	50.0%
	1.0...200.0%	Frequency.	1 = 1%
97.135	<i>UDC ripple</i>	Calculates ripple voltage.	-
	0.0...200.0 V	Voltage	1 = 1 V

No.	Name/Value	Description	Def/FbEq16
98 User motor parameters		Motor values supplied by the user that are used in the motor model. These parameters are useful for non-standard motors, or to just get more accurate motor control of the motor on site. A better motor model always improves the shaft performance.	
98.01	<i>User motor model mode</i>	Activates the motor model parameters 98.02...98.12 and 98.14. Notes: <ul style="list-style-type: none"> Parameter value is automatically set to zero when ID run is selected by parameter 99.13 ID run requested. The values of parameters 98.02...98.12 are then updated according to the motor characteristics identified during the ID run. Measurements made directly from the motor terminals during the ID run are likely to produce slightly different values than those on a data sheet from a motor manufacturer. This parameter cannot be changed while the drive is running. 	Not selected
	Not selected	Parameters 98.02...98.12 inactive.	0
	Motor parameters	The values of parameters 98.02...98.12 are used as the motor model.	1
98.02	<i>Rs user</i>	Defines the stator resistance R_S of the motor model. With a star-connected motor, R_S is the resistance of one winding. With a delta-connected motor, R_S is one-third of the resistance of one winding.	0.00000 p.u.
	0.00000...0.50000 p.u.	Stator resistance in per unit.	
98.03	<i>Rr user</i>	Defines the rotor resistance R_R of the motor model. Note: This parameter is valid only for asynchronous motors.	0.00000 p.u.
	0.00000...0.50000 p.u.	Rotor resistance in per unit.	
98.04	<i>Lm user</i>	Defines the main inductance L_M of the motor model. Note: This parameter is valid only for asynchronous motors.	0.00000 p.u.
	0.00000...10.00000 p.u.	Main inductance in per unit.	
98.05	<i>SigmaL user</i>	Defines the leakage inductance σL_S . Note: This parameter is valid only for asynchronous motors.	0.00000 p.u.
	0.00000...1.00000 p.u.	Leakage inductance in per unit.	
98.06	<i>Ld user</i>	Defines the direct axis (synchronous) inductance. Note: This parameter is valid only for permanent magnet motors.	0.00000 p.u.
	0.00000...10.00000 p.u.	Direct axis inductance in per unit.	
98.07	<i>Lq user</i>	Defines the quadrature axis (synchronous) inductance. Note: This parameter is valid only for permanent magnet motors.	0.00000 p.u.
	0.00000...10.00000 p.u.	Quadrature axis inductance in per unit.	



No.	Name/Value	Description	Def/FbEq16
98.08	<i>PM flux user</i>	Defines the permanent magnet flux. Note: This parameter is valid only for permanent magnet motors.	0.00000 p.u.
	0.00000... 2.00000 p.u	Permanent magnet flux in per unit.	
98.09	<i>Rs user SI</i>	Defines the stator resistance R_S of the motor model.	0.00000 ohm
	0.00000...100.000 00 ohm	Stator resistance.	100 = 1 ohm
98.10	<i>Rr user SI</i>	Defines the rotor resistance R_R of the motor model. Note: This parameter is valid only for asynchronous motors.	0.00000 ohm
	0.00000...100.000 00 ohm	Rotor resistance.	100 = 1 ohm
98.11	<i>Lm user SI</i>	Defines the main inductance L_M of the motor model. Note: This parameter is valid only for asynchronous motors.	0.00 mH
	0.00...100000.00 mH	Main inductance.	1 = 1 mH
98.12	<i>SigmaL user SI</i>	Defines the leakage inductance σL_S . Note: This parameter is valid only for asynchronous motors.	0.00 mH
	0.00...100000.00 mH	Leakage inductance.	1 = 1 mH
98.13	<i>Ld user SI</i>	Defines the direct axis (synchronous) inductance. Note: This parameter is valid only for permanent magnet motors.	0.00 mH
	0.00...100000.00 mH	Direct axis inductance.	1 = 1 mH
98.14	<i>Lq user SI</i>	Defines the quadrature axis (synchronous) inductance. Note: This parameter is valid only for permanent magnet motors.	0.00 mH
	0.00...100000.00 mH	Quadrature axis inductance.	1 = 1 mH

99 Motor data		Motor configuration settings.	
99.03	<i>Motor type</i>	Selects the motor type. Note: This parameter cannot be changed while the drive is running.	<i>Asynchronous motor</i>
	Asynchronous motor	Standard squirrel cage AC induction motor (asynchronous induction motor).	0
	Permanent magnet motor	Permanent magnet motor. Three-phase AC synchronous motor with permanent magnet rotor and sinusoidal BackEMF voltage. Note: With permanent magnet motors special attention must be paid on setting the motor nominal values correctly in parameter group 99 Motor data. You must use vector control. If the nominal BackEMF voltage of the motor is not available, a full ID run should be performed for improving performance.	1
	SynRM	Synchronous reluctance motor. Three-phase AC synchronous motor with salient pole rotor without permanent magnets. With synchronous reluctance motors you must use vector control.	2

No.	Name/Value	Description	Def/FbEq16
99.04	<i>Motor control mode</i>	Selects the motor control mode.	<i>Scalar</i>
	Vector	<p>Vector control. Vector control has better accuracy than scalar control but cannot be used in all situations (see selection <i>Scalar</i> below).</p> <p>Requires motor identification run (ID run). See parameter <i>99.13 ID run requested</i>.</p> <p>Notes:</p> <ul style="list-style-type: none"> • In vector control the drive performs a standstill ID run at the first start if ID run has not been previously performed. A new start command is required after standstill ID run. • To achieve a better motor control performance, you can perform a normal ID run without load. <p>See also section <i>Operating modes of the drive</i> (page 90).</p>	0
	Scalar	<p>Scalar control. Suitable for most applications, if top performance is not required.</p> <p>Motor identification run is not required.</p> <p>Note: Scalar control must be used in the following situations:</p> <ul style="list-style-type: none"> • with multimotor systems 1) if the load is not equally shared between the motors, 2) if the motors are of different sizes, or 3) if the motors are going to be changed after the motor identification (ID run) • if the nominal current of the motor is less than 1/6 of the nominal output current of the drive • if the drive is used with no motor connected (for example, for test purposes). <p>Note: Correct motor operation requires that the magnetizing current of the motor does not exceed 90% of the nominal current of the inverter.</p> <p>See also section <i>Operating modes of the drive</i> (page 90).</p>	1
99.06	<i>Motor nominal current</i>	<p>Defines the nominal motor current. Must be equal to the value on the motor rating plate. If multiple motors are connected to the drive, enter the total current of the motors.</p> <p>Notes:</p> <ul style="list-style-type: none"> • Correct motor operation requires that the magnetizing current of the motor does not exceed 90% of the nominal current of the drive. • This parameter cannot be changed while the drive is running. <p>For 16-bit scaling, see parameter <i>46.05 Current scaling</i>.</p>	0.0 A
	0.0...6400.0 A	Nominal current of the motor. The allowable range is $1/6 \dots 2 \times I_N$ of the drive ($0 \dots 2 \times I_N$ with scalar control mode).	1 = 1 A

No.	Name/Value	Description	Def/FbEq16
99.07	<i>Motor nominal voltage</i>	Defines the nominal motor voltage supplied to the motor. This setting must match the value on the rating plate of the motor. Notes: <ul style="list-style-type: none"> • With permanent magnet motors, the nominal voltage is the BackEMF voltage at nominal speed of the motor. If the voltage is given as voltage per rpm, for example, 60 V per 1000 rpm, the voltage for a nominal speed of 3000 rpm is $3 \times 60 \text{ V} = 180 \text{ V}$. • The stress on the motor insulation is always dependent on the drive supply voltage. This also applies to the case where the motor voltage rating is lower than that of the drive and the supply. • This parameter cannot be changed while the drive is running. 	0.0 V
	0.0...960.0 V	Nominal voltage of the motor.	10 = 1 V
99.08	<i>Motor nominal frequency</i>	Defines the nominal motor frequency. This setting must match the value on the rating plate of the motor. Note: This parameter cannot be changed while the drive is running.	50.00 Hz
	0.00...500.00 Hz	Nominal frequency of the motor.	10 = 1 Hz
99.09	<i>Motor nominal speed</i>	Defines the nominal motor speed. The setting must match the value on the rating plate of the motor. Note: This parameter cannot be changed while the drive is running.	0 rpm
	0...30000 rpm	Nominal speed of the motor.	1 = 1 rpm
99.10	<i>Motor nominal power</i>	Defines the nominal motor power. The setting must match the value on the rating plate of the motor. If multiple motors are connected to the drive, enter the total power of the motors. The unit is selected by parameter 96.16 Unit selection . Note: This parameter cannot be changed while the drive is running. For 16-bit scaling, see parameter 46.04 Power scaling .	0.00 kW or hp
	0.00... 10000.00 kW or 0.00... 13404.83 hp	Nominal power of the motor.	1 = 1 unit
99.11	<i>Motor nominal cos ϕ</i>	Defines the cosphi of the motor for a more accurate motor model. The value is not obligatory, but is useful with an asynchronous motor, especially when performing a standstill identification run. With a permanent magnet or synchronous reluctance motor, this value is not needed. Notes: <ul style="list-style-type: none"> • Do not enter an estimated value. If you do not know the exact value, leave the parameter at zero. • This parameter cannot be changed while the drive is running. 	0.00
	0.00...1.00	Cosphi of the motor.	100 = 1

No.	Name/Value	Description	Def/FbEq16
99.12	<i>Motor nominal torque</i>	Defines the nominal motor shaft torque for a more accurate motor model. Not obligatory. The unit is selected by parameter 96.16 Unit selection . Note: This parameter cannot be changed while the drive is running.	0.000 N·m or lb·ft
	0.000... 4000000.000 N·m or 0.000... 2950248.597 lb·ft	Nominal motor torque.	1 = 100 unit
99.13	<i>ID run requested</i>	Selects the type of the motor identification routine (ID run) performed at the next start of the drive. During the ID run, the drive will identify the characteristics of the motor for optimum motor control. If no ID run has been performed yet (or if default parameter values have been restored using parameter 96.06 Parameter restore), this parameter is automatically set to <i>Standstill</i> , signifying that an ID run must be performed. After the ID run, the drive stops and this parameter is automatically set to <i>None</i> . Notes: <ul style="list-style-type: none"> • To ensure that the ID run can work properly, the drive limits in group 30 (maximum speed and minimum speed, and maximum torque and minimum torque) must be large enough (the range specified by the limits must be wide enough. If, for example, speed limits are less than the motor nominal speed, the ID run cannot be completed. • For the <i>Advanced</i> ID run, the machinery must always be de-coupled from the motor. • With a permanent magnet or synchronous reluctance motor, a <i>Normal</i>, <i>Reduced</i> or <i>Standstill</i> ID run requires that the motor shaft is NOT locked and the load torque is less than 10%. • With scalar control mode (99.04 Motor control mode = Scalar), the ID run is not requested automatically. However, an ID run can be performed for more accurate torque estimation. • Once the ID run is activated, it can be canceled by stopping the drive. • The ID run must be performed every time any of the motor parameters (99.04, 99.06...99.12) have been changed. • Ensure that the Safe Torque Off and emergency stop circuits (if any) are closed during the ID run. • Mechanical brake (if present) is not opened by the logic for the ID run. • This parameter cannot be changed while the drive is running. 	<i>None</i>
	None	No motor ID run is requested. This mode can be selected only if the ID run (<i>Normal</i> / <i>Reduced</i> / <i>Standstill</i> / <i>Advanced</i>) has already been performed once.	0

No.	Name/Value	Description	Def/FbEq16
	Normal	<p>Normal ID run. Guarantees good control accuracy for all cases. The ID run takes about 90 seconds. This mode should be selected whenever it is possible.</p> <p>Notes:</p> <ul style="list-style-type: none"> • If the load torque will be higher than 20% of motor nominal torque, or if the machinery is not able to withstand the nominal torque transient during the ID run, then the driven machinery must be de-coupled from the motor during a Normal ID run. • Check the direction of rotation of the motor before starting the ID run. During the run, the motor will rotate in the forward direction. <p> WARNING! The motor will run at up to approximately 50...100% of the nominal speed during the ID run. ENSURE THAT IT IS SAFE TO RUN THE MOTOR BEFORE PERFORMING THE ID RUN!</p>	1
	Reduced	<p>Reduced ID run. This mode should be selected instead of the <i>Normal</i> or <i>Advanced</i> ID run if</p> <ul style="list-style-type: none"> • mechanical losses are higher than 20% (ie. the motor cannot be de-coupled from the driven equipment), or if • flux reduction is not allowed while the motor is running (ie. in case of a motor with an integrated brake supplied from the motor terminals). <p>With this ID run mode, the resultant motor control in the field weakening area or at high torques is not necessarily as accurate as motor control following a Normal ID run. Reduced ID run is completed faster than the Normal ID run (< 90 seconds).</p> <p>Note: Check the direction of rotation of the motor before starting the ID run. During the run, the motor will rotate in the forward direction.</p> <p> WARNING! The motor will run at up to approximately 50...100% of the nominal speed during the ID run. ENSURE THAT IT IS SAFE TO RUN THE MOTOR BEFORE PERFORMING THE ID RUN!</p>	2
	Standstill	<p>Standstill ID run. The motor is injected with DC current. With an AC induction (asynchronous) motor, the motor shaft is not rotated. With a permanent magnet motor, the shaft can rotate up to half a revolution.</p> <p>Note: This mode should be selected only if the <i>Normal</i>, <i>Reduced</i> or <i>Advanced</i> ID run is not possible due to the restrictions caused by the connected mechanics (for example, with lift or crane applications).</p>	3
	Reserved		4
	Current measurement calibration	<p>Current offset and gain measurement calibration is set to calibrate the control loops. The calibration will be performed at the next start. Only for frames R6...R11.</p>	5

No.	Name/Value	Description	Def/FbEq16
	Advanced	Advanced ID run. Only for frames R6...R9 and ACQ580-31 and ACQ580-34 drives. Guarantees the best possible control accuracy. The ID run takes a very long time to complete. This mode should be selected when top performance is needed across the whole operating area. Note: The driven machinery must be de-coupled from the motor because of high torque and speed transients that are applied.  WARNING! The motor may run at up to the maximum (positive) and minimum (negative) allowed speed during the ID run. Several accelerations and decelerations are done. The maximum torque, current and speed allowed by the limit parameters may be utilized. ENSURE THAT IT IS SAFE TO RUN THE MOTOR BEFORE PERFORMING THE ID RUN!	6
	Reserved		7
	Adaptive	Adaptive ID run. Improves the motor model accuracy during normal operation of the drive. The drive performs a Standstill ID run first. Motor parameters are then updated with better accuracy during an adaptation sequence when following user's driving profile. When the adaptation is complete, parameters 99.14 Last ID run performed changes from Standstill to Adaptive. Motor parameters are updated automatically and the user is not required to update any other parameter.	8
99.14	Last ID run performed	Shows the type of ID run that was performed last. For more information about the different modes, see the selections of parameter 99.13 ID run requested .	<i>None</i>
	None	No ID run has been performed.	0
	Normal	<i>Normal</i> ID run.	1
	Reduced	<i>Reduced</i> ID run.	2
	Standstill	<i>Standstill</i> ID run.	3
	Reserved		4
	Current measurement calibration	Current measurement calibration.	5
	Advanced	<i>Advanced</i> ID run.	6
	Reserved		7
	Adaptive	<i>Adaptive</i> ID run.	8
99.15	Motor polepairs calculated	Calculated number of pole pairs in the motor.	-
	0...1000	Number of pole pairs.	1 = 1
99.16	Motor phase order	Switches the rotation direction of motor. This parameter can be used if the motor turns in the wrong direction (for example, because of the wrong phase order in the motor cable), and correcting the cabling is considered impractical. Note: <ul style="list-style-type: none"> Changing this parameter does not affect speed reference polarities, so positive speed reference will rotate the motor forward. The phase order selection just ensures that "forward" is in fact the correct direction. 	<i>U V W</i>
	U V W	Normal.	0

No.	Name/Value	Description	Def/FbEq16
	U W V	Reversed rotation direction.	1

Differences in the default values between 50 Hz and 60 Hz supply frequency settings

Parameter *95.20 HW options word 1 bit 0 Supply frequency 60 Hz* changes the drive parameter default values according to the supply frequency, 50 Hz or 60 Hz. The bit is set according to the market before the drive is delivered.

If you need to change from 50 Hz to 60 Hz, or vice versa, change the value of the bit and then do a complete reset to the drive. After that you have to reselect the macro to be used.

The table below shows the parameters whose default values depend on the supply frequency setting. The supply frequency setting, with the type designation of the drive, also affects Group *99 Motor data* parameter values though these parameters are not listed in the table.

No.	Name	95.20 HW options word 1 bit Supply frequency 60 Hz = 50 Hz	95.20 HW options word 1 bit Supply frequency 60 Hz = 60 Hz
11.45	<i>Freq in 1 at scaled max</i>	1500.000	1800.000
15.35	<i>Freq out 1 src max</i>	1500.000	1800.000
12.20	<i>AI1 scaled at AI1 max</i>	50.000	60.000
13.18	<i>AO1 source max</i>	50.0	60.0
22.26	<i>Constant speed 1</i>	300.00 rpm	360.00 rpm
22.27	<i>Constant speed 2</i>	600.00 rpm	720.00 rpm
22.28	<i>Constant speed 3</i>	900 .00 rpm	1080.00 rpm
22.29	<i>Constant speed 4</i>	1200.00 rpm	1440.00 rpm
22.30	<i>Constant speed 5</i>	1500.00 rpm	1800.00 rpm
22.31	<i>Constant speed 6</i>	2400.00 rpm	2880.00 rpm
22.32	<i>Constant speed 7</i>	3000.00 rpm	3600.00 rpm
28.26	<i>Constant frequency 1</i>	5.00 Hz	6.00 Hz
28.27	<i>Constant frequency 2</i>	10.00 Hz	12.00 Hz
28.28	<i>Constant frequency 3</i>	15.00 Hz	18.00 Hz
28.29	<i>Constant frequency 4</i>	20.00 Hz	24.00 Hz
28.30	<i>Constant frequency 5</i>	25.00 Hz	30.00 Hz
28.31	<i>Constant frequency 6</i>	40.00 Hz	48.00 Hz
28.32	<i>Constant frequency 7</i>	50.00 Hz	60.00 Hz

No.	Name	95.20 HW options word 1 bit Supply frequency 60 Hz = 50 Hz	95.20 HW options word 1 bit Supply frequency 60 Hz = 60 Hz
30.12	<i>Maximum speed</i>	1500.00 rpm	1800.00 rpm
30.14	<i>Maximum frequency</i>	50.00 Hz	60.00 Hz
31.26	<i>Stall speed limit</i>	150.00 rpm	180.00 rpm
31.27	<i>Stall frequency limit</i>	15.00 Hz	18.00 Hz
31.30	<i>Overspeed trip margin</i>	500.00 rpm	500.00 rpm
46.01	<i>Speed scaling</i>	1500.00 rpm	1800.00 rpm
46.02	<i>Frequency scaling</i>	50.00 Hz	60.00 Hz
46.31	<i>Above speed limit</i>	1500.00 rpm	1800.00 rpm
46.32	<i>Above frequency limit</i>	50.00 Hz	60.00 Hz

Parameters supported by Modbus legacy compatibility

Legacy compatibility mode is a way to communicate with a legacy drive in such a way that it looks like the legacy drive over Modbus RTU or Modbus TCP. This mode can be enabled by changing parameter [96.78 550 Compatibility mode](#) to *Enabled* or, in firmware versions 2.15 or later, parameter [96.78 Legacy Modbus mapping](#) to *Enable*.

In the legacy compatibility mode all supported parameters can be read as if the drive were a legacy drive. Some parameters are read only and do not support writes. See the table below to see which parameters support writes.

Legacy parameter	Name	Read/Write	Legacy parameter	Name	Read/Write
01.01	SPEED & DIR	Read only	01.34	COMM RO WORD	Read only
01.02	SPEED	Read only	01.35	COMM VALUE 1	Read only
01.03	OUTPUT FREQ	Read only	01.36	COMM VALUE 2	Read only
01.04	CURRENT	Read only	01.41	MWH COUNTER	Read only
01.05	TORQUE	Read only	01.43	DRIVE ON TIME	Read only
01.06	POWER	Read only	01.45	MOTOR TEMP	Read only
01.07	DC BUS VOLTAGE	Read only	01.50	CB TEMP	Read only
01.09	OUTPUT VOLTAGE	Read only	01.74	SAVED KWH	Read only
01.10	DRIVE TEMP	Read only	01.75	SAVED MWH	Read only
01.11	EXTERNAL REF 1	Read only	01.77	SAVED AMOUNT 2	Read only
01.13	CTRL LOCATION	Read only	01.78	SAVED CO2	Read only
01.14	RUN TIME	Read only	03.01	FB CMD WORD 1	Read only
01.15	KWH COUNTER	Read only	03.02	FB CMD WORD 2	Read only
01.18	DI 1-3 STATUS	Read only	03.03	FB STS WORD 1	Read only
01.19	DI 4-6 STATUS	Read only	03.04	FB STS WORD 2	Read only
01.20	AI 1	Read only	03.05	FAULT WORD 1	Read only
01.21	AI 2	Read only	03.06	FAULT WORD 2	Read only
01.22	RO 1-3 STATUS	Read only	03.07	FAULT WORD 3	Read only
01.23	RO 4-6 STATUS	Read only	03.08	ALARM WORD 1	Read only
01.24	AO 1	Read only	03.09	ALARM WORD 2	Read only
01.25	AO 2	Read only	04.01	LAST FAULT	Read only
01.26	PID 1 OUTPUT	Read only	04.12	PREVIOUS FAULT 1	Read only
01.27	PID 2 OUTPUT	Read only	04.13	PREVIOUS FAULT 2	Read only
01.28	PID 1 SETPNT	Read only	10.01	EXT1 COMMANDS	Read/Write
01.29	PID 2 SETPNT	Read only	10.02	EXT2 COMMANDS	Read/Write
01.30	PID 1 FBK	Read only	10.03	DIRECTION	Read/Write
01.31	PID 2 FBK	Read only	10.04	JOGGING SEL	Read/Write
01.32	PID 1 DEVIATION	Read only	11.02	EXT1/EXT2 SEL	Read/Write
01.33	PID 2 DEVIATION	Read only	11.03	REF1 SELECT	Read/Write

Legacy parameter	Name	Read/Write
11.04	REF1 MIN	Read/Write
11.05	REF1 MAX	Read/Write
11.06	REF2 SEL	Read/Write
11.07	REF2 MIN	Read/Write
11.08	REF2 MAX	Read/Write
12.01	CONST SPEED SEL	Read/Write
12.02	CONST SPEED 1	Read/Write
12.03	CONST SPEED 2	Read/Write
12.04	CONST SPEED 3	Read/Write
12.05	CONST SPEED 4	Read/Write
12.06	CONST SPEED 5	Read/Write
12.07	CONST SPEED 6	Read/Write
15.02	CONST SPEED 7	Read/Write
15.03	AO1 CONTENT MAX	Read/Write
15.04	MINIMUM AO1	Read/Write
15.05	MAXIMUM AO1	Read/Write
15.08	AO2 CONTENT MIN	Read/Write
15.09	AO2 CONTENT MAX	Read/Write
15.10	MINIMUM AO2	Read/Write
15.11	MAXIMUM AO2	Read/Write
16.01	RUN ENABLE	Read/Write
16.02	PARAMETER LOCK	Read/Write
16.03	PASS CODE	Read/Write
16.08	START ENABLE 1	Read/Write
16.09	START ENABLE 2	Read/Write
20.01	MINIMUM SPEED	Read/Write
20.02	MAXIMUM SPEED	Read/Write
20.03	MAX CURRENT	Read/Write
20.06	UNDERVOLT CRTL	Read/Write
20.07	MINIMUM FREQ	Read/Write
20.08	MAXIMUM FREQ	Read/Write
20.13	MIN TORQUE SEL	Read/Write
20.14	MAX TORQUE SEL	Read/Write
20.15	MIN TORQUE 1	Read/Write
20.16	MIN TORQUE 2	Read/Write
20.17	MAX TORQUE 1	Read/Write
20.18	MAX TORQUE 2	Read/Write
21.02	STOP FUNCTION	Read/Write
21.03	DC MAGN TIME	Read/Write

Legacy parameter	Name	Read/Write
21.05	DC HOLD SPEED	Read/Write
21.06	DC CURR REF	Read/Write
21.09	EMERG STOP SEL	Read/Write
21.12	ZERO SPEED DELAY	Read/Write
21.13	START DELAY	Read/Write
22.02	ACCELER TIME 1	Read/Write
22.03	DECELER TIME 1	Read/Write
22.04	RAMP SHAPE 1	Read/Write
22.05	ACCELER TIME 2	Read/Write
22.06	DECELER TIME 2	Read/Write
22.07	RAMP SHAPE 2	Read/Write
22.08	EMERG DEC TIME	Read/Write
23.01	PROP GAIN	Read/Write
23.02	INTEGRATION TIME	Read/Write
23.03	DERIVATION TIME	Read/Write
23.04	ACC COMPENSATION	Read/Write
30.02	PANEL COMM ERR	Read/Write
30.03	EXTERNAL REF 1	Read/Write
30.04	EXTERNAL REF 2	Read/Write
30.05	MOT THERM POT	Read/Write
30.06	MOT THERM TIME	Read/Write
30.07	MOT LOAD CURVE	Read/Write
30.08	ZERO SPEED LOAD	Read/Write
30.09	BREAK POINT FREQ	Read/Write
30.10	STALL FUNCTION	Read/Write
30.11	STALL FREQUENCY	Read/Write
30.12	STALL TIME	Read/Write
30.17	EARTH FAULT	Read/Write
30.18	COMM FAULT FUNC	Read/Write
30.19	COMM FAULT TIME	Read/Write
30.22	AI2 FAULT LIMIT	Read/Write
30.23	WIRING FAULT	Read/Write
33.01	FIRMWARE	Read only
33.02	LOADING PACKAGE	Read only
33.03	TEST DATE	Read only
33.04	DRIVE RATING	Read only
40.01	GAIN	Read/Write
40.02	INTEGRATION TIME	Read/Write
40.03	DERIVATION TIME	Read/Write

Legacy parameter	Name	Read/Write
40.04	PID DERIV FILTER	Read/Write
40.08	0% VALUE	Read/Write
40.09	100% VALUE	Read/Write
40.10	SET POINT SEL	Read/Write
40.11	INTERNAL SETPNT	Read/Write
40.12	SETPOINT MIN	Read/Write
40.13	SETPOINT MAX	Read/Write
40.14	FBK SEL	Read/Write
40.15	FBK MULTIPLIER	Read/Write
40.16	ACT 1 INPUT	Read/Write
40.17	ACT 2 INPUT	Read/Write
40.24	PID SLEEP DELAY	Read/Write
40.25	WAKE-UP DEV	Read/Write
40.26	WAKE-UP DELAY	Read/Write
40.27	PID 1 PARAM SET	Read/Write
41.01	GAIN	Read/Write
41.02	INTEGRATION TIME	Read/Write
41.03	DERIVATION TIME	Read/Write
41.04	PID DERIV FILTER	Read/Write
41.08	0% VALUE	Read/Write
41.09	100% VALUE	Read/Write
41.10	SET POINT SEL	Read/Write

Legacy parameter	Name	Read/Write
41.11	INTERNAL SETPNT	Read/Write
41.12	SETPOINT MIN	Read/Write
41.13	SETPOINT MAX	Read/Write
41.14	FBK SEL	Read/Write
41.15	FBK MULTIPLIER	Read/Write
41.16	ACT 1 INPUT	Read/Write
41.17	ACT 2 INPUT	Read/Write
41.24	PID SLEEP DELAY	Read/Write
41.25	WAKE-UP DEV	Read/Write
41.26	WAKE-UP DELAY	Read/Write
42.11	INTERNAL SETPNT	Read/Write
53.05	EFB CTRL PROFILE	Read/Write
99.01	LANGUAGE	Read/Write
99.04	MOTOR CTRL MODE	Read/Write
99.05	MOTOR NOM VOLT	Read/Write
99.06	MOTOR NOM CURR	Read/Write
99.07	MOTOR NOM FREQ	Read/Write
99.08	MOTOR NOM SPEED	Read/Write
99.09	MOTOR NOM POWER	Read/Write
99.10	ID RUN	Read/Write
99.15	MOTOR COS PHI	Read/Write



Additional parameter data

What this chapter contains

This chapter lists the parameters with some additional data such as their ranges and 32-bit fieldbus scaling. For parameter descriptions, see chapter [Parameters](#) (page 283).

Terms and abbreviations

Term	Definition
Actual signal	Signal measured or calculated by the drive. Usually can only be monitored but not adjusted; some counter-type signals can however be reset.
Analog src	Analog source: the parameter can be set to the value of another parameter by choosing "Other", and selecting the source parameter from a list. In addition to the "Other" selection, the parameter may offer other pre-selected settings.
Binary src	Binary source: the value of the parameter can be taken from a specific bit in another parameter value ("Other"). Sometimes the value can be fixed to 0 (false) or 1 (true). In addition, the parameter may offer other pre-selected settings.
Data	Data parameter
FbEq32	32-bit fieldbus equivalent: The scaling between the value shown on the control panel and the integer used in communication when a 32-bit value is selected for transmission to an external system. The corresponding 16-bit scalings are listed in chapter Parameters (page 283).
List	Selection list.

Term	Definition
No.	Parameter number.
PB	Packed Boolean (bit list).
Real	Real number.
Type	Parameter type. See Analog src , Binary src , List , PB , Real .

Fieldbus addresses

Refer to the *User's manual* of the fieldbus adapter.

Parameter groups 1...9

No.	Name	Type	Range	Unit	FbEq32
01 Actual values					
01.01	Motor speed used	Real	-30000.00...30000.00	rpm	100 = 1 rpm
01.02	Motor speed estimated	Real	-30000.00...30000.00	rpm	100 = 1 rpm
01.03	Motor speed %	Real	-1000.00...1000.00	%	100 = 1%
01.06	Output frequency	Real	-500.00...500.00	Hz	100 = 1 Hz
01.07	Motor current	Real	0.00...30000.00	A	100 = 1 A
01.08	Motor current % of motor nom	Real	0.0...1000.0	%	10 = 1%
01.09	Motor current % of drive nom	Real	0.0...1000.0	%	10 = 1%
01.10	Motor torque	Real	-1600.0...1600.0	%	10 = 1%
01.11	DC voltage	Real	0.00...2000.00	V	100 = 1 V
01.13	Output voltage	Real	0...2000	V	1 = 1 V
01.14	Output power	Real	-32768.00...32767.00	kW	100 = kW
01.15	Output power % of motor nom	Real	-300.00...300.00	%	100 = 1%
01.17	Motor shaft power	Real	-32768.00...32767.00	kW or hp	100 = 1 unit
01.18	Inverter GWh counter	Real	0...65535	GWh	1 = 1 GWh
01.19	Inverter MWh counter	Real	0...1000	MWh	1 = 1 MWh
01.20	Inverter kWh counter	Real	0...1000	kWh	1 = 1 kWh
01.24	Flux actual %	Real	0...200	%	1 = 1%
01.30	Nominal torque scale	Real	0.000...4000000	N·m or lb-ft	1000 = 1 unit
01.31	Ambient temperature	Real	-40.0...120.0	°C or °F	10 = 1 unit
01.50	Current hour kWh	Real	0.00...1000000.00	kWh	100 = 1 kWh
01.51	Previous hour kWh	Real	0.00...1000000.00	kWh	100 = 1 kWh
01.52	Current day kWh	Real	0.00...1000000.00	kWh	100 = 1 kWh
01.53	Previous day kWh	Real	0.00...1000000.00	kWh	100 = 1 kWh
01.54	Cumulative inverter energy	Real	-200000000.0... 200000000.0	kWh	1 = 1 kWh
01.55	Inverter GWh counter (resettable)	Real	0...65535	GWh	1 = 1 GWh
01.56	Inverter MWh counter (resettable)	Real	0...1000	MWh	1 = 1 MWh
01.57	Inverter kWh counter (resettable)	Real	0...1000	kWh	1 = 1 kWh
01.58	Cumulative inverter energy (resettable)	Real	-200000000.0... 200000000.0	kWh	1 = 1 kWh
01.61	Abs motor speed used		0.00...30000.00	rpm	100 = 1 rpm
01.62	Abs motor speed %		0.00...1000.00%	%	100 = 1%
01.63	Abs output frequency		0.00...500.00 Hz	Hz	100 = 1 Hz
01.64	Abs motor torque		0.0...1600.0	%	10 = 1%
01.65	Abs output power		0.00...32767.00	kW	100 = 1 kW
01.66	Abs output power % motor nom		0.00...300.00	%	100 = 1%
01.67	Abs output power % drive nom		0.00...300.00	%	100 = 1%

No.	Name	Type	Range	Unit	FbEq32
01.68	Abs motor shaft power		0.00...32767.00	kW or hp	100 = 1 unit
<i>(Parameters 01.102...01.164 only visible for ACQ580-31 and ACQ580-34).</i>					
01.102	Line current	<i>Real</i>	0.00...30000.00	A	100 = 1 A
01.104	Active current	<i>Real</i>	0.00...30000.00	A	100 = 1 A
01.106	Reactive current	<i>Real</i>	0.00...30000.00	A	100 = 1 A
01.108	Grid frequency	<i>Real</i>	0.00...100.00	Hz	100 = 1 Hz
01.109	Grid voltage	<i>Real</i>	0.00...2000.00	V	100 = 1 V
01.110	Grid apparent power	<i>Real</i>	-30000.00...30000.00	kVA	100 = 1 kVA
01.112	Grid power	<i>Real</i>	-30000.00...30000.00	kW	100 = 1 kW
01.114	Grid reactive power	<i>Real</i>	-30000.00...30000.00	kvar	100 = 1 kvar
01.116	LSU cos Phi	<i>Real</i>	-1.00...1.00	-	100 = 1
01.164	LSU nominal power	<i>Real</i>	0...30000	kW	1 = 1 kW
03 Input references					
03.01	Panel reference	<i>Real</i>	-100000.00...100000.00	-	100 = 1
03.02	Panel reference remote	<i>Real</i>	-100000.00...100000.00	-	100 = 1
03.05	FB A reference 1	<i>Real</i>	-100000.00...100000.00	-	100 = 1
03.06	FB A reference 2	<i>Real</i>	-100000.00...100000.00	-	100 = 1
03.09	EFB reference 1	<i>Real</i>	-30000.00...30000.00	-	100 = 1
03.10	EFB reference 2	<i>Real</i>	-30000.00...30000.00	-	100 = 1
04 Warnings and faults					
04.01	Tripping fault	<i>Data</i>	0000h...FFFFh	-	1 = 1
04.02	Active fault 2	<i>Data</i>	0000h...FFFFh	-	1 = 1
04.03	Active fault 3	<i>Data</i>	0000h...FFFFh	-	1 = 1
04.06	Active warning 1	<i>Data</i>	0000h...FFFFh	-	1 = 1
04.07	Active warning 2	<i>Data</i>	0000h...FFFFh	-	1 = 1
04.08	Active warning 3	<i>Data</i>	0000h...FFFFh	-	1 = 1
04.11	Latest fault	<i>Data</i>	0000h...FFFFh	-	1 = 1
04.12	2nd latest fault	<i>Data</i>	0000h...FFFFh	-	1 = 1
04.13	3rd latest fault	<i>Data</i>	0000h...FFFFh	-	1 = 1
04.16	Latest warning	<i>Data</i>	0000h...FFFFh	-	1 = 1
04.17	2nd latest warning	<i>Data</i>	0000h...FFFFh	-	1 = 1
04.18	3rd latest warning	<i>Data</i>	0000h...FFFFh	-	1 = 1
04.40	Event word 1	<i>PB</i>	0000h...FFFFh	-	1 = 1
04.41	Event word 1 bit 0 code	<i>Data</i>	0000h...FFFFh	-	1 = 1
04.43	Event word 1 bit 1 code	<i>Data</i>	0000h...FFFFh	-	1 = 1
04.45, 04.47, 04.49,	
04.71	Event word 1 bit 15 code	<i>Data</i>	0000h...FFFFh	-	1 = 1
05 Diagnostics					
05.01	On-time counter	<i>Real</i>	0...65535	d	1 = 1 d

No.	Name	Type	Range	Unit	FbEq32
05.02	Run-time counter	<i>Real</i>	0...65535	d	1 = 1 d
05.03	Hours run	<i>Real</i>	0.0...429496729.5	h	10 = 1 h
05.04	Fan on-time counter	<i>Real</i>	0...65535	d	1 = 1 d
05.08	Cabinet temperature	<i>Real</i>	-40...120	°C or °F	10 = 1 unit
05.10	Control board temperature	<i>Real</i>	-100...300	°C or °F	10 = 1 unit
05.11	Inverter temperature	<i>Real</i>	-40.0...160.0	%	10 = 1%
05.20	Diagnostic word 1	<i>PB</i>	0000h...FFFFh	-	
05.21	Diagnostic word 2	<i>PB</i>	0000h...FFFFh	-	
05.22	Diagnostic word 3	<i>PB</i>	0000h...FFFFh	-	
05.80	Motor speed at fault	<i>Real</i>	-30000...30000.00	rpm	100 = 1 rpm
05.81	Output frequency at fault	<i>Real</i>	-500.00...500.00	Hz	100 = 1 Hz
05.82	DC voltage at fault	<i>Real</i>	0.00...2000.00	V	100 = 1 V
05.83	Motor current at fault	<i>Real</i>	0.00...30000.00	A	100 = 1 A
05.84	Motor torque at fault	<i>Real</i>	-1600.0...1600.0	%	10 = 1%
05.85	Main status word at fault	<i>PB</i>	0000h...FFFFh	-	1 = 1
05.86	DI delayed status at fault	<i>PB</i>	0000h...FFFFh	-	1 = 1
05.87	Inverter temperature at fault	<i>Real</i>	-40.0...160.0	%	10 = 1%
05.88	Reference used at fault	<i>Real</i>	-500.00...500.00 or -30000.00...30000.00	Hz or rpm	100 = 1 unit
05.89	Hand-off-auto status word at fault	<i>PB</i>	0000h...FFFFh	-	1 = 1
<i>(Parameters 05.111...05.121 only visible for ACQ580-31 and ACQ580-34)</i>					
05.111	Line converter temperature	<i>Real</i>	-40.0...160.0	%	10 = 1%
05.121	MCB closing counter	<i>Real</i>	0...4294967295	%	1 = 1
06 Control and status words					
06.01	Main control word	<i>PB</i>	0000h...FFFFh	-	1 = 1
06.11	Main status word	<i>PB</i>	0000h...FFFFh	-	1 = 1
06.16	Drive status word 1	<i>PB</i>	0000h...FFFFh	-	1 = 1
06.17	Drive status word 2	<i>PB</i>	0000h...FFFFh	-	1 = 1
06.18	Start inhibit status word	<i>PB</i>	0000h...FFFFh	-	1 = 1
06.19	Speed control status word	<i>PB</i>	0000h...FFFFh	-	1 = 1
06.20	Constant speed status word	<i>PB</i>	0000h...FFFFh	-	1 = 1
06.21	Drive status word 3	<i>PB</i>	0000h...FFFFh	-	1 = 1
06.22	Hand-off-auto status word	<i>PB</i>	0000h...FFFFh	-	1 = 1
06.29	MSW bit 10 selection	<i>Binary src</i>	-	-	1 = 1
06.30	MSW bit 11 selection	<i>Binary src</i>	-	-	1 = 1
06.31	MSW bit 12 selection	<i>Binary src</i>	-	-	1 = 1
06.32	MSW bit 13 selection	<i>Binary src</i>	-	-	1 = 1

No.	Name	Type	Range	Unit	FbEq32
06.33	MSW bit 14 selection	<i>Binary src</i>	-	-	1 = 1
<i>(Parameters 06.36...06.118 only visible for ACQ580-31 and ACQ580-34)</i>					
06.36	LSU Status word	<i>PB</i>	0000h...FFFFh	-	1 = 1
06.39	Internal state machine LSU CW	<i>PB</i>	0000h...FFFFh	-	1 = 1
06.116	LSU drive status word 1	<i>PB</i>	0000h...FFFFh	-	1 = 1
06.118	LSU start inhibit status word	<i>PB</i>	0000h...FFFFh	-	1 = 1
07 System info					
07.03	Drive rating id	<i>List</i>	0...999	-	1 = 1
07.04	Firmware name	<i>List</i>	-	-	1 = 1
07.05	Firmware version	<i>Data</i>	-	-	1 = 1
07.06	Loading package name	<i>List</i>	-	-	1 = 1
07.07	Loading package version	<i>Data</i>	-	-	1 = 1
07.10	Language file set	<i>List</i>	1...3	-	1 = 1
07.11	Cpu usage	<i>Real</i>	0...100	%	1 = 1%
07.25	Customization package name	<i>Data</i>	-	-	1 = 1
07.26	Customization package version	<i>Data</i>	-	-	1 = 1
07.30	Adaptive program status	<i>PB</i>	0000h...FFFFh	-	1 = 1
07.31	AP sequence state	<i>Data</i>	0...20	-	1 = 1
07.35	Drive configuration		0000h...FFFFh		
07.36	Drive configuration 2		0000h...FFFFh		
<i>(Parameters 07.106...07.107 only visible for ACQ580-31 and ACQ580-34)</i>					
07.106	LSU loading package name	<i>List</i>	-	-	1 = 1
07.107	LSU loading package version	<i>Data</i>	-	-	1 = 1

Parameter groups 10...99

No.	Name	Type	Range	Unit	FbEq32
10 Standard DI, RO					
10.01	DI status	<i>PB</i>	0000h...FFFFh	-	1 = 1
10.02	DI delayed status	<i>PB</i>	0000h...FFFFh	-	1 = 1
10.03	DI force selection	<i>PB</i>	0000h...FFFFh	-	1 = 1
10.04	DI forced data	<i>PB</i>	0000h...FFFFh	-	1 = 1
10.05	DI1 ON delay	<i>Real</i>	0.0...3000.0	s	10 = 1 s
10.06	DI1 OFF delay	<i>Real</i>	0.0...3000.0	s	10 = 1 s
10.07	DI2 ON delay	<i>Real</i>	0.0...3000.0	s	10 = 1 s
10.08	DI2 OFF delay	<i>Real</i>	0.0...3000.0	s	10 = 1 s
10.09	DI3 ON delay	<i>Real</i>	0.0...3000.0	s	10 = 1 s
10.10	DI3 OFF delay	<i>Real</i>	0.0...3000.0	s	10 = 1 s
10.11	DI4 ON delay	<i>Real</i>	0.0...3000.0	s	10 = 1 s
10.12	DI4 OFF delay	<i>Real</i>	0.0...3000.0	s	10 = 1 s
10.13	DI5 ON delay	<i>Real</i>	0.0...3000.0	s	10 = 1 s
10.14	DI5 OFF delay	<i>Real</i>	0.0...3000.0	s	10 = 1 s
10.15	DI6 ON delay	<i>Real</i>	0.0...3000.0	s	10 = 1 s
10.16	DI6 OFF delay	<i>Real</i>	0.0...3000.0	s	10 = 1 s
10.21	RO status	<i>PB</i>	0000h...FFFFh	-	1 = 1
10.22	RO force selection	<i>PB</i>	0000h...FFFFh	-	1 = 1
10.23	RO forced data	<i>PB</i>	0000h...FFFFh	-	1 = 1
10.24	RO1 source	<i>Binary src</i>	-	-	1 = 1
10.25	RO1 ON delay	<i>Real</i>	0.0...3000.0	s	10 = 1 s
10.26	RO1 OFF delay	<i>Real</i>	0.0...3000.0	s	10 = 1 s
10.27	RO2 source	<i>Binary src</i>	-	-	1 = 1
10.28	RO2 ON delay	<i>Real</i>	0.0...3000.0	s	10 = 1 s
10.29	RO2 OFF delay	<i>Real</i>	0.0...3000.0	s	10 = 1 s
10.30	RO3 source	<i>Binary src</i>	-	-	1 = 1
10.31	RO3 ON delay	<i>Real</i>	0.0...3000.0	s	10 = 1 s
10.32	RO3 OFF delay	<i>Real</i>	0.0...3000.0	s	10 = 1 s
10.99	RO/DIO control word	<i>PB</i>	0000h...FFFFh	-	1 = 1
10.101	RO1 toggle counter	<i>Real</i>	0...4294967000	-	1 = 1
10.102	RO2 toggle counter	<i>Real</i>	0...4294967000	-	1 = 1
10.103	RO3 toggle counter	<i>Real</i>	0...4294967000	-	1 = 1
11 Standard DIO, FI, FO					
11.21	DI5 configuration	<i>List</i>	0...1	-	1 = 1
11.38	Freq in 1 actual value	<i>Real</i>	0...16000	Hz	1 = 1 Hz
11.39	Freq in 1 scaled value	<i>Real</i>	-32768.000...32767.000	-	1000 = 1

No.	Name	Type	Range	Unit	FbEq32
11.42	Freq in 1 min	<i>Real</i>	0...16000	Hz	1 = 1 Hz
11.43	Freq in 1 max	<i>Real</i>	0...16000	Hz	1 = 1 Hz
11.44	Freq in 1 at scaled min	<i>Real</i>	-32768.000...32767.000	-	1000 = 1
11.45	Freq in 1 at scaled max	<i>Real</i>	-32768.000...32767.000	-	1000 = 1
12 Standard AI					
12.02	AI force selection	<i>PB</i>	0000h...FFFFh	-	1 = 1
12.03	AI supervision function	<i>List</i>	0...4	-	1 = 1
12.04	AI supervision selection	<i>PB</i>	0000h...FFFFh	-	1 = 1
12.11	AI1 actual value	<i>Real</i>	0.000...22.000 mA or 0.000...11.000 V	mA or V	1000 = 1 unit
12.12	AI1 scaled value	<i>Real</i>	-32768.000...32767.000	-	1000 = 1
12.13	AI1 forced value	<i>Real</i>	0.000...20.000 mA or 0.000...10.000 V	mA or V	1000 = 1 unit
12.15	AI1 unit selection	<i>List</i>	2, 10	-	1 = 1
12.16	AI1 filter time	<i>Real</i>	0.000...30.000	s	1000 = 1 s
12.17	AI1 min	<i>Real</i>	0.000...20.000 mA or 0.000...10.000 V	mA or V	1000 = 1 unit
12.18	AI1 max	<i>Real</i>	0.000...22.000 mA or 0.000...11.000 V	mA or V	1000 = 1 unit
12.19	AI1 scaled at AI1 min	<i>Real</i>	-32768.000...32767.000	-	1000 = 1
12.20	AI1 scaled at AI1 max	<i>Real</i>	-32768.000...32767.000	-	1000 = 1
12.21	AI2 actual value	<i>Real</i>	0.000...22.000 mA or 0.000...11.000 V	mA or V	1000 = 1 unit
12.22	AI2 scaled value	<i>Real</i>	-32768.000...32767.000	-	1000 = 1
12.23	AI2 forced value	<i>Real</i>	0.000...20.000 mA or 0.000...10.000 V	mA or V	1000 = 1 unit
12.25	AI2 unit selection	<i>List</i>	2, 10	-	1 = 1
12.26	AI2 filter time	<i>Real</i>	0.000...30.000	s	1000 = 1 s
12.27	AI2 min	<i>Real</i>	0.000...20.000 mA or 0.000...10.000 V	mA or V	1000 = 1 unit
12.28	AI2 max	<i>Real</i>	0.000...22.000 mA or 0.000...11.000 V	mA or V	1000 = 1 unit
12.29	AI2 scaled at AI2 min	<i>Real</i>	-32768.000...32767.000	-	1000 = 1
12.30	AI2 scaled at AI2 max	<i>Real</i>	-32768.000...32767.000	-	1000 = 1
12.101	AI1 percent value	<i>Real</i>	0.00...100.00	%	100 = 1%
12.102	AI2 percent value	<i>Real</i>	0.00...100.00	%	100 = 1%
13 Standard AO					
13.02	AO force selection	<i>PB</i>	0000h...FFFFh	-	1 = 1
13.11	AO1 actual value	<i>Real</i>	0.000...22.000 mA or 0.000...11.000 V	mA or V	1000 = 1 unit
13.12	AO1 source	<i>Analog src</i>	-	-	1 = 1
13.13	AO1 forced value	<i>Real</i>	0.000...22.000 mA or 0.000...11.000 V	mA or V	1000 = 1 unit
13.15	AO1 unit selection	<i>List</i>	2, 10	-	1 = 1

No.	Name	Type	Range	Unit	FbEq32
13.16	AO1 filter time	<i>Real</i>	0.000...30.000	s	1000 = 1 s
13.17	AO1 source min	<i>Real</i>	-32768.0...32767.0	-	10 = 1
13.18	AO1 source max	<i>Real</i>	-32768.0...32767.0	-	10 = 1
13.19	AO1 out at AO1 src min	<i>Real</i>	0.000...22.000 mA or 0.000...11000 V	mA or V	1000 = 1 unit
13.20	AO1 out at AO1 src max	<i>Real</i>	0.000...22.000 mA or 0.000...11000 V	mA or V	1000 = 1 unit
13.21	AO2 actual value	<i>Real</i>	0.000...22.000	mA	1000 = 1 mA
13.22	AO2 source	<i>Analog src</i>	-	-	1 = 1
13.23	AO2 forced value	<i>Real</i>	0.000...22.000	mA	1000 = 1 mA
13.26	AO2 filter time	<i>Real</i>	0.000...30.000	s	1000 = 1 s
13.27	AO2 source min	<i>Real</i>	-32768.0...32767.0	-	10 = 1
13.28	AO2 source max	<i>Real</i>	-32768.0...32767.0	-	10 = 1
13.29	AO2 out at AO2 src min	<i>Real</i>	0.000...22.000	mA	1000 = 1 mA
13.30	AO2 out at AO2 src max	<i>Real</i>	0.000...22.000	mA	1000 = 1 mA
13.91	AO1 data storage	<i>Real</i>	-327.68...327.67	-	100 = 1
13.92	AO2 data storage	<i>Real</i>	-327.68...327.67	-	100 = 1
15 I/O extension module					
15.01	Extension module type	<i>List</i>	0...4	-	1 = 1
15.02	Detected extension module	<i>List</i>	0...4	-	1 = 1
15.03	DI status	<i>PB</i>	0000h...FFFFh	-	1 = 1
15.04	RO/DO status	<i>PB</i>	0000h...FFFFh	-	1 = 1
15.05	RO/DO force selection	<i>PB</i>	0000h...FFFFh	-	1 = 1
15.06	RO/DO forced data	<i>PB</i>	0000h...FFFFh	-	1 = 1
15.07	RO4 source	<i>Binary src</i>	-	-	1 = 1
15.08	RO4 ON delay	<i>Real</i>	0.0...3000.0	s	10 = 1 s
15.09	RO4 OFF delay	<i>Real</i>	0.0...3000.0	s	10 = 1 s
15.10	RO5 source	<i>Binary src</i>	-	-	1 = 1
15.11	RO5 ON delay	<i>Real</i>	0.0...3000.0	s	10 = 1 s
15.12	RO5 OFF delay	<i>Real</i>	0.0...3000.0	s	10 = 1 s
15.13	RO6 source	<i>Binary src</i>	-	-	1 = 1
15.14	RO6 ON delay	<i>Real</i>	0.0...3000.0	s	10 = 1 s
15.15	RO6 OFF delay	<i>Real</i>	0.0...3000.0	s	10 = 1 s
15.16	RO7 source	<i>Binary src</i>	-	-	1 = 1
15.17	RO7 ON delay	<i>Real</i>	0.0...3000.0	s	10 = 1 s
15.18	RO7 OFF delay	<i>Real</i>	0.0...3000.0	s	10 = 1 s
15.22	DO1 configuration	<i>List</i>	0, 2	-	1 = 1
15.23	DO1 source	<i>Binary src</i>	-	-	1 = 1

No.	Name	Type	Range	Unit	FbEq32
15.24	DO1 ON delay	<i>Real</i>	0.0...3000.0	s	10 = 1 s
15.25	DO1 OFF delay	<i>Real</i>	0.0...3000.0	s	10 = 1 s
15.32	Freq out 1 actual value	<i>Real</i>	0...16000	Hz	1 = 1 Hz
15.33	Freq out 1 source	<i>Analog src</i>	-	-	1 = 1
15.34	Freq out 1 src min	<i>Real</i>	-32768.0...32767.0	-	1000 = 1
15.35	Freq out 1 src max	<i>Real</i>	-32768.0...32767.0	-	1000 = 1
15.36	Freq out 1 at src min	<i>Real</i>	0...16000	Hz	1 = 1 Hz
15.37	Freq out 1 at src max	<i>Real</i>	0...16000	Hz	1 = 1 Hz
19 Operation mode					
19.01	Actual operation mode	<i>List</i>	1...2, 10, 20	-	1 = 1
19.11	Ext1/Ext2 selection	<i>Binary src</i>	-	-	1 = 1
19.18	HAND/OFF disable source	<i>Binary src</i>	-	-	1 = 1
19.19	HAND/OFF disable action	<i>List</i>	0...2	-	1 = 1
20 Start/stop/direction					
20.01	Ext1 commands	<i>List</i>	0...6, 11...12, 14	-	1 = 1
20.02	Ext1 start trigger type	<i>List</i>	0...1	-	1 = 1
20.03	Ext1 in1 source	<i>Binary src</i>	-	-	1 = 1
20.04	Ext1 in2 source	<i>Binary src</i>	-	-	1 = 1
20.05	Ext1 in3 source	<i>Binary src</i>	-	-	1 = 1
20.06	Ext2 commands	<i>List</i>	0...6, 11...12, 14	-	1 = 1
20.07	Ext2 start trigger type	<i>List</i>	0...1	-	1 = 1
20.08	Ext2 in1 source	<i>Binary src</i>	-	-	1 = 1
20.09	Ext2 in2 source	<i>Binary src</i>	-	-	1 = 1
20.10	Ext2 in3 source	<i>Binary src</i>	-	-	1 = 1
20.21	Direction	<i>List</i>	0...2	-	1 = 1
20.30	Enable signal warning function	<i>PB</i>	0000h...FFFFh	-	1 = 1
20.40	Run permissive	<i>Binary src</i>	-	-	1 = 1
20.41	Start interlock 1	<i>Binary src</i>	-	-	1 = 1
20.42	Start interlock 2	<i>Binary src</i>	-	-	1 = 1
20.43	Start interlock 3	<i>Binary src</i>	-	-	1 = 1
20.44	Start interlock 4	<i>Binary src</i>	-	-	1 = 1

No.	Name	Type	Range	Unit	FbEq32
20.45	Start interlock stop mode	<i>Binary src</i>	-	-	1 = 1
20.46	Run permissive text	<i>Binary src</i>	-	-	1 = 1
20.47	Start interlock 1 text	<i>Binary src</i>	-	-	1 = 1
20.48	Start interlock 2 text	<i>Binary src</i>	-	-	1 = 1
20.49	Start interlock 3 text	<i>Binary src</i>	-	-	1 = 1
20.50	Start interlock 4 text	<i>Binary src</i>	-	-	1 = 1
20.51	Start interlock condition	<i>Binary src</i>	-	-	1 = 1
21 Start/stop mode					
21.01	Start mode	<i>List</i>	0...2	-	1 = 1
21.02	Magnetization time	<i>Real</i>	0...10000	ms	1 = 1 ms
21.03	Stop mode	<i>List</i>	0...2	-	1 = 1
21.04	Emergency stop mode	<i>List</i>	0...2	-	1 = 1
21.05	Emergency stop source	<i>Binary src</i>	-	-	1 = 1
21.06	Zero speed limit	<i>Real</i>	0.00...30000.00	rpm	100 = 1 rpm
21.07	Zero speed delay	<i>Real</i>	0...30000	ms	1 = 1 ms
21.08	DC current control	<i>PB</i>	0000b...0011b	-	1 = 1
21.09	DC hold speed	<i>Real</i>	0.00...1000.00	rpm	100 = 1 rpm
21.10	DC current reference	<i>Real</i>	0.0...100.0	%	10 = 1%
21.11	Post magnetization time	<i>Real</i>	0...3000	s	1 = 1 s
21.13	Autophasing mode	<i>List</i>	0, 5	-	1 = 1
21.14	Pre-heating input source	<i>Binary src</i>	-	-	1 = 1
21.15	Pre-heating time delay	<i>Real</i>	0...3000	s	1 = 1 s
21.16	Pre-heating current	<i>Real</i>	0.0...30.0	%	10 = 1%
21.18	Auto restart time	<i>Real</i>	0.0, 0.1...10.0	s	10 = 1 s
21.19	Scalar start mode	<i>List</i>	0...6	-	1 = 1
21.21	DC hold frequency	<i>Real</i>	0.00...1000.00	Hz	100 = 1 Hz
21.22	Start delay	<i>Real</i>	0.00...60.00	s	100 = 1 s
21.23	Smooth start	<i>Real</i>	0...2	-	1 = 1
21.24	Smooth start current	<i>Real</i>	10.0...200.0	%	100 = 1%
21.25	Smooth start speed	<i>Real</i>	2.0...100.0	%	100 = 1%
21.26	Torque boost current	<i>Real</i>	15.0...300.0	%	100 = 1%
21.27	Torque boost time	<i>Real</i>	0.0...60.0	s	10 = 1 s
21.34	Force auto restart	<i>List</i>	0...1	-	1 = 1
21.35	Preheating power	<i>Real</i>	0.00...10.00	kW	100 = 1
21.36	Preheating unit	<i>List</i>	0...1	-	1 = 1

No.	Name	Type	Range	Unit	FbEq32
22 Speed reference selection					
22.01	Speed ref unlimited	<i>Real</i>	-30000.00...30000.00	rpm	100 = 1 rpm
22.11	Ext1 speed ref1	<i>Analog src</i>	-	-	1 = 1
22.18	Ext2 speed ref1	<i>Analog src</i>	-	-	1 = 1
22.21	Constant speed function	<i>PB</i>	0000h...FFFFh	-	1 = 1
22.22	Constant speed sel1	<i>Binary src</i>	-	-	1 = 1
22.23	Constant speed sel2	<i>Binary src</i>	-	-	1 = 1
22.24	Constant speed sel3	<i>Binary src</i>	-	-	1 = 1
22.25	Constant speed sel4	<i>Binary src</i>	-	-	1 = 1
22.26	Constant speed 1	<i>Real</i>	-30000.00...30000.00	rpm	100 = 1 rpm
22.27	Constant speed 2	<i>Real</i>	-30000.00...30000.00	rpm	100 = 1 rpm
22.28	Constant speed 3	<i>Real</i>	-30000.00...30000.00	rpm	100 = 1 rpm
22.29	Constant speed 4	<i>Real</i>	-30000.00...30000.00	rpm	100 = 1 rpm
22.30	Constant speed 5	<i>Real</i>	-30000.00...30000.00	rpm	100 = 1 rpm
22.31	Constant speed 6	<i>Real</i>	-30000.00...30000.00	rpm	100 = 1 rpm
22.32	Constant speed 7	<i>Real</i>	-30000.00...30000.00	rpm	100 = 1 rpm
22.41	Speed ref safe	<i>Real</i>	-30000.00...30000.00	rpm	100 = 1 rpm
22.46	Constant speed sel5	<i>Binary src</i>	-	-	1 = 1
22.47	Constant speed sel6	<i>Binary src</i>	-	-	1 = 1
22.51	Critical speed function	<i>PB</i>	00b...11b	-	1 = 1
22.52	Critical speed 1 low	<i>Real</i>	-30000.00...30000.00	rpm	100 = 1 rpm
22.53	Critical speed 1 high	<i>Real</i>	-30000.00...30000.00	rpm	100 = 1 rpm
22.54	Critical speed 2 low	<i>Real</i>	-30000.00...30000.00	rpm	100 = 1 rpm
22.55	Critical speed 2 high	<i>Real</i>	-30000.00...30000.00	rpm	100 = 1 rpm
22.56	Critical speed 3 low	<i>Real</i>	-30000.00...30000.00	rpm	100 = 1 rpm
22.57	Critical speed 3 high	<i>Real</i>	-30000.00...30000.00	rpm	100 = 1 rpm
22.71	Motor potentiometer function	<i>List</i>	0...4	-	1 = 1
22.72	Motor potentiometer initial value	<i>Real</i>	-32768.00...32767.00	-	100 = 1
22.73	Motor potentiometer up source	<i>Binary src</i>	-	-	1 = 1
22.74	Motor potentiometer down source	<i>Binary src</i>	-	-	1 = 1
22.75	Motor potentiometer ramp time	<i>Real</i>	0.0...3600.0	s	10 = 1 s
22.76	Motor potentiometer min value	<i>Real</i>	-32768.00...32767.00	-	100 = 1
22.77	Motor potentiometer max value	<i>Real</i>	-32768.00...32767.00	-	100 = 1

No.	Name	Type	Range	Unit	FbEq32
22.80	Motor potentiometer ref act	<i>Real</i>	-32768.00...32767.00	-	100 = 1
22.86	Speed reference act 6	<i>Real</i>	-30000.00...30000.00	rpm	100 = 1 rpm
22.87	Speed reference act 7	<i>Real</i>	-30000.00...30000.00	rpm	100 = 1 rpm
23 Speed reference ramp					
23.01	Speed ref ramp input	<i>Real</i>	-30000.00...30000.00	rpm	100 = 1 rpm
23.02	Speed ref ramp output	<i>Real</i>	-30000.00...30000.00	rpm	100 = 1 rpm
23.12	Acceleration time 1	<i>Real</i>	0.000...1800.000	s	1000 = 1 s
23.13	Deceleration time 1	<i>Real</i>	0.000...1800.000	s	1000 = 1 s
23.23	Emergency stop time	<i>Real</i>	0.000...1800.000	s	1000 = 1 s
23.32	Shape time 1	<i>Real</i>	0.000...1800.000	s	1000 = 1 s
24 Speed reference conditioning					
24.01	Used speed reference	<i>Real</i>	-30000.00...30000.00	rpm	100 = 1 rpm
24.02	Used speed feedback	<i>Real</i>	-30000.00...30000.00	rpm	100 = 1 rpm
24.03	Speed error filtered	<i>Real</i>	-30000.0...30000.0	rpm	100 = 1 rpm
24.04	Speed error inverted	<i>Real</i>	-30000.0...30000.0	rpm	100 = 1 rpm
24.11	Speed correction	<i>Real</i>	-10000.00...10000.00	rpm	100 = 1 rpm
24.12	Speed error filter time	<i>Real</i>	0...10000	ms	1 = 1 ms
25 Speed control					
25.01	Torque reference speed control	<i>Real</i>	-1600.0...1600.0	%	10 = 1%
25.02	Speed proportional gain	<i>Real</i>	0.00...250.00	-	100 = 1
25.03	Speed integration time	<i>Real</i>	0.00...1000.00	s	100 = 1 s
25.04	Speed derivation time	<i>Real</i>	0.000...10.000	s	1000 = 1 s
25.05	Derivation filter time	<i>Real</i>	0...10000	ms	1 = 1 ms
25.15	Proportional gain em stop	<i>Real</i>	1.00...250.00	-	100 = 1
25.33	Speed controller auto tune	<i>Binary src</i>	-	-	1 = 1
25.34	Auto tune control preset	<i>List</i>	0...2	-	1 = 1
25.37	Mechanical time constant	<i>Real</i>	0.00...1000.00	s	100 = 1 s
25.38	Auto tune torque step	<i>Real</i>	0.00...20.00	%	100 = 1%
25.39	Auto tune speed step	<i>Real</i>	0.00...20.00	%	100 = 1%
25.40	Auto tune repeat times	<i>Real</i>	0...10	-	1 = 1
25.53	Torque prop reference	<i>Real</i>	-30000.0...30000.0	%	10 = 1%
25.54	Torque integral reference	<i>Real</i>	-30000.0...30000.0	%	10 = 1%
25.55	Torque deriv reference	<i>Real</i>	-30000.0...30000.0	%	10 = 1%
28 Frequency reference chain					
28.01	Frequency ref ramp input	<i>Real</i>	-500.00...500.00	Hz	100 = 1 Hz
28.02	Frequency ref ramp output	<i>Real</i>	-500.00...500.00	Hz	100 = 1 Hz
28.11	Ext1 frequency ref1	<i>Analog src</i>	-	-	1 = 1
28.15	Ext2 frequency ref1	<i>Analog src</i>	-	-	1 = 1

No.	Name	Type	Range	Unit	FbEq32
28.21	Constant frequency function	<i>PB</i>	00b...11b	-	1 = 1
28.22	Constant frequency sel1	<i>Binary src</i>	-	-	1 = 1
28.23	Constant frequency sel2	<i>Binary src</i>	-	-	1 = 1
28.24	Constant frequency sel3	<i>Binary src</i>	-	-	1 = 1
28.25	Constant frequency sel4	<i>Binary src</i>	-	-	1 = 1
28.26	Constant frequency 1	<i>Real</i>	-500.00...500.00	Hz	100 = 1 Hz
28.27	Constant frequency 2	<i>Real</i>	-500.00...500.00	Hz	100 = 1 Hz
28.28	Constant frequency 3	<i>Real</i>	-500.00...500.00	Hz	100 = 1 Hz
28.29	Constant frequency 4	<i>Real</i>	-500.00...500.00	Hz	100 = 1 Hz
28.30	Constant frequency 5	<i>Real</i>	-500.00...500.00	Hz	100 = 1 Hz
28.31	Constant frequency 6	<i>Real</i>	-500.00...500.00	Hz	100 = 1 Hz
28.32	Constant frequency 7	<i>Real</i>	-500.00...500.00	Hz	100 = 1 Hz
28.41	Frequency ref safe	<i>Real</i>	-500.00...500.00	Hz	100 = 1 Hz
28.46	Constant frequency sel5	<i>Binary src</i>	-	-	1 = 1
28.47	Constant frequency sel6	<i>Binary src</i>	-	-	1 = 1
28.51	Critical frequency function	<i>PB</i>	00b...11b	-	1 = 1
28.52	Critical frequency 1 low	<i>Real</i>	-500.00...500.00	Hz	100 = 1 Hz
28.53	Critical frequency 1 high	<i>Real</i>	-500.00...500.00	Hz	100 = 1 Hz
28.54	Critical frequency 2 low	<i>Real</i>	-500.00...500.00	Hz	100 = 1 Hz
28.55	Critical frequency 2 high	<i>Real</i>	-500.00...500.00	Hz	100 = 1 Hz
28.56	Critical frequency 3 low	<i>Real</i>	-500.00...500.00	Hz	100 = 1 Hz
28.57	Critical frequency 3 high	<i>Real</i>	-500.00...500.00	Hz	100 = 1 Hz
28.72	Freq acceleration time 1	<i>Real</i>	0.000...1800.000	s	1000 = 1 s
28.73	Freq deceleration time 1	<i>Real</i>	0.000...1800.000	s	1000 = 1 s
28.76	Freq ramp in zero source	<i>Binary src</i>	-	-	1 = 1
28.82	Shape time 1	<i>Real</i>	0.000...1800.000	s	1000 = 1 s
28.92	Frequency ref act 3	<i>Real</i>	-500.00...500.00	Hz	100 = 1 Hz
28.96	Frequency ref act 7	<i>Real</i>	-500.00...500.00	Hz	100 = 1 Hz
28.97	Frequency ref unlimited	<i>Real</i>	-500.00...500.00	Hz	100 = 1 Hz
30 Limits					
30.01	Limit word 1	<i>PB</i>	0000h...FFFFh	-	1 = 1
30.02	Torque limit status	<i>PB</i>	0000h...FFFFh	-	1 = 1
30.11	Minimum speed	<i>Real</i>	-30000.00...30000.00	rpm	100 = 1 rpm
30.12	Maximum speed	<i>Real</i>	-30000.00...30000.00	rpm	100 = 1 rpm
30.13	Minimum frequency	<i>Real</i>	-500.00...500.00	Hz	100 = 1 Hz
30.14	Maximum frequency	<i>Real</i>	-500.00...500.00	Hz	100 = 1 Hz

No.	Name	Type	Range	Unit	FbEq32
30.17	Maximum current	<i>Real</i>	0.00...30000.00	A	100 = 1 A
30.19	Minimum torque 1	<i>Real</i>	-1600.0...0.0	%	10 = 1%
30.20	Maximum torque 1	<i>Real</i>	0.0...1600.0	%	10 = 1%
30.26	Power motoring limit	<i>Real</i>	0.00...600.00	%	100 = 1%
30.27	Power generating limit	<i>Real</i>	-600.00...0.00	%	100 = 1%
30.30	Overvoltage control	<i>List</i>	0...1	-	1 = 1
30.31	Undervoltage control	<i>List</i>	0...1	-	1 = 1
30.35	Thermal current limitation	<i>List</i>	0...1	-	1 = 1
30.36	Speed limit selection	<i>Binary src</i>	-	-	1 = 1
30.37	Minimum speed source	<i>Analog src</i>	-	-	1 = 1
30.38	Maximum speed source	<i>Analog src</i>	-	-	1 = 1
<i>(Parameters 30.101...30.149 only visible for ACQ580-31 and ACQ580-34)</i>					
30.101	LSU limit word 1	<i>PB</i>	0000h...FFFFh	-	1 = 1
30.102	LSU limit word 2	<i>PB</i>	0000h...FFFFh	-	1 = 1
30.103	LSU limit word 3	<i>PB</i>	0000h...FFFFh	-	1 = 1
30.104	LSU limit word 4	<i>PB</i>	0000h...FFFFh	-	1 = 1
30.149	LSU maximum power limit	<i>Real</i>	0.0...200.0	%	10 = 1%
31 Fault functions					
31.01	External event 1 source	<i>Binary src</i>	-	-	1 = 1
31.02	External event 1 type	<i>List</i>	0...1	-	1 = 1
31.03	External event 2 source	<i>Binary src</i>	-	-	1 = 1
31.04	External event 2 type	<i>List</i>	0...1	-	1 = 1
31.05	External event 3 source	<i>Binary src</i>	-	-	1 = 1
31.06	External event 3 type	<i>List</i>	0...1	-	1 = 1
31.07	External event 4 source	<i>Binary src</i>	-	-	1 = 1
31.08	External event 4 type	<i>List</i>	0...1	-	1 = 1
31.09	External event 5 source	<i>Binary src</i>	-	-	1 = 1
31.10	External event 5 type	<i>List</i>	0...1	-	1 = 1
31.11	Fault reset selection	<i>Binary src</i>	-	-	1 = 1
31.12	Autoreset selection	<i>PB</i>	0000h...FFFFh	-	1 = 1
31.13	Selectable fault	<i>Real</i>	0000h...FFFFh	-	1 = 1
31.14	Number of trials	<i>Real</i>	0...5	-	1 = 1
31.15	Total trials time	<i>Real</i>	1.0...600.0	s	10 = 1 s
31.16	Delay time	<i>Real</i>	0.0...120.0	s	10 = 1 s
31.19	Motor phase loss	<i>List</i>	0...1	-	1 = 1

No.	Name	Type	Range	Unit	FbEq32
31.21	Supply phase loss	List	0...1	-	1 = 1
31.22	STO indication run/stop	List	0...5	-	1 = 1
31.23	Wiring or earth fault	List	0...1	-	1 = 1
31.24	Stall function	List	0...2	-	1 = 1
31.25	Stall current limit	Real	0.0...1600.0	%	10 = 1%
31.26	Stall speed limit	Real	0.00...10000.00	rpm	100 = 1 rpm
31.27	Stall frequency limit	Real	0.00...1000.00	Hz	100 = 1 Hz
31.28	Stall time	Real	0...3600	s	1 = 1 s
31.30	Overspeed trip margin	Real	0.00...10000.00	rpm	100 = 1 rpm
31.31	Frequency trip margin	Real	0.00...10000.00	Hz	100 = 1 Hz
31.32	Emergency ramp supervision	Real	0...300	%	1 = 1%
31.33	Emergency ramp supervision delay	Real	0...100	s	1 = 1 s
31.35	Main fan fault function	List	0...2	-	1 = 1
31.36	Aux fan fault function	List	0...1	-	1 = 1
31.40	Disable warning messages	PB	0000h...FFFFh	-	1 = 1
<i>(Parameters 31.50...31.51 only visible for ACQ580-07)</i>					
31.50	Cabinet temp warning limit	Real		°C	-
31.51	Cabinet temp fault limit	Real		°C	-
<i>(Parameters 31.120...31.121 only visible for ACQ580-31 and ACQ580-34)</i>					
31.120	LSU earth fault	List	0...1	-	1 = 1
31.121	LSU supply phase loss	List	0...1	-	1 = 1
32 Supervision					
32.01	Supervision status	PB	0000h...FFFFh	-	1 = 1
32.05	Supervision 1 function	List	0...7	-	1 = 1
32.06	Supervision 1 action	List	0...3	-	1 = 1
32.07	Supervision 1 signal	Analog src	-	-	1 = 1
32.08	Supervision 1 filter time	Real	0.000...30.000	s	1000 = 1 s
32.09	Supervision 1 low	Real	-21474836.00... 21474836.00	-	100 = 1
32.10	Supervision 1 high	Real	-21474836.00... 21474836.00	-	100 = 1
32.11	Supervision 1 hysteresis	Real	0.00...100000.00	-	100 = 1
32.15	Supervision 2 function	List	0...7	-	1 = 1
32.16	Supervision 2 action	List	0...3	-	1 = 1
32.17	Supervision 2 signal	Analog src	-	-	1 = 1
32.18	Supervision 2 filter time	Real	0.000...30.000	s	1000 = 1 s
32.19	Supervision 2 low	Real	-21474836.00... 21474836.00	-	100 = 1
32.20	Supervision 2 high	Real	-21474836.00... 21474836.00	-	100 = 1

No.	Name	Type	Range	Unit	FbEq32
32.21	Supervision 2 hysteresis	<i>Real</i>	0.00...100000.00	-	100 = 1
32.25	Supervision 3 function	<i>List</i>	0...7	-	1 = 1
32.26	Supervision 3 action	<i>List</i>	0...3	-	1 = 17
32.27	Supervision 3 signal	<i>Analog src</i>	-	-	1 = 1
32.28	Supervision 3 filter time	<i>Real</i>	0.000...30.000	s	1000 = 1 s
32.29	Supervision 3 low	<i>Real</i>	-21474836.00... 21474836.00	-	100 = 1
32.30	Supervision 3 high	<i>Real</i>	-21474836.00... 21474836.00	-	100 = 1
32.31	Supervision 3 hysteresis	<i>Real</i>	0.00...100000.00	-	100 = 1
32.35	Supervision 4 function	<i>List</i>	0...7	-	1 = 1
32.36	Supervision 4 action	<i>List</i>	0...3	-	1 = 1
32.37	Supervision 4 signal	<i>Analog src</i>	-	-	1 = 1
32.38	Supervision 4 filter time	<i>Real</i>	0.000...30.000	s	1000 = 1 s
32.39	Supervision 4 low	<i>Real</i>	-21474836.00... 21474836.00	-	100 = 1
32.40	Supervision 4 high	<i>Real</i>	-21474836.00... 21474836.00	-	100 = 1
32.41	Supervision 4 hysteresis	<i>Real</i>	0.00...100000.00	-	100 = 1
32.45	Supervision 5 function	<i>List</i>	0...7	-	1 = 1
32.46	Supervision 5 action	<i>List</i>	0...3	-	1 = 1
32.47	Supervision 5 signal	<i>Analog src</i>	-	-	1 = 1
32.48	Supervision 5 filter time	<i>Real</i>	0.000...30.000	s	1000 = 1 s
32.49	Supervision 5 low	<i>Real</i>	-21474836.00... 21474836.00	-	100 = 1
32.50	Supervision 5 high	<i>Real</i>	-21474836.00... 21474836.00	-	100 = 1
32.51	Supervision 5 hysteresis	<i>Real</i>	0.00...100000.00	-	100 = 1
32.55	Supervision 6 function	<i>List</i>	0...7	-	1 = 1
32.56	Supervision 6 action	<i>List</i>	0...3	-	1 = 1
32.57	Supervision 6 signal	<i>Analog src</i>	-	-	1 = 1
32.58	Supervision 6 filter time	<i>Real</i>	0.000...30.000	s	1000 = 1 s
32.59	Supervision 6 low	<i>Real</i>	-21474836.00... 21474836.00	-	100 = 1
32.60	Supervision 6 high	<i>Real</i>	-21474836.00... 21474836.00	-	100 = 1
32.61	Supervision 6 hysteresis	<i>Real</i>	0.00...100000.00	-	100 = 1
34 Timed functions					
34.01	Timed functions status	<i>PB</i>	0000h...FFFFh	-	1 = 1
34.02	Timer status	<i>PB</i>	0000h...FFFFh	-	1 = 1
34.04	Season/exception day status	<i>PB</i>	0000h...FFFFh	-	1 = 1

No.	Name	Type	Range	Unit	FbEq32
34.10	Timed functions enable	<i>Binary src</i>	-	-	1 = 1
34.11	Timer 1 configuration	<i>PB</i>	0000h...FFFFh	-	1 = 1
34.12	Timer 1 start time	Time	00:00:00...23:59:59	s	1 = 1 s
34.13	Timer 1 duration	Duration	00 00:00...07 00:00	min	1 = 1 min
34.14	Timer 2 configuration	<i>PB</i>	0000h...FFFFh	-	1 = 1
34.15	Timer 2 start time	Time	00:00:00...23:59:59	s	1 = 1 s
34.16	Timer 2 duration	Duration	00 00:00...07 00:00	min	1 = 1 min
34.17	Timer 3 configuration	<i>PB</i>	0000h...FFFFh	-	1 = 1
34.18	Timer 3 start time	Time	00:00:00...23:59:59	s	1 = 1 s
34.19	Timer 3 duration	Duration	00 00:00...07 00:00	min	1 = 1 min
34.20	Timer 4 configuration	<i>PB</i>	0000h...FFFFh	-	1 = 1
34.21	Timer 4 start time	Time	00:00:00...23:59:59	s	1 = 1 s
34.22	Timer 4 duration	Duration	00 00:00...07 00:00	min	1 = 1 min
34.23	Timer 5 configuration	<i>PB</i>	0000h...FFFFh	-	1 = 1
34.24	Timer 5 start time	Time	00:00:00...23:59:59	s	1 = 1 s
34.25	Timer 5 duration	Duration	00 00:00...07 00:00	min	1 = 1 min
34.26	Timer 6 configuration	<i>PB</i>	0000h...FFFFh	-	1 = 1
34.27	Timer 6 start time	Time	00:00:00...23:59:59	s	1 = 1 s
34.28	Timer 6 duration	Duration	00 00:00...07 00:00	min	1 = 1 min
34.29	Timer 7 configuration	<i>PB</i>	0000h...FFFFh	-	1 = 1
34.30	Timer 7 start time	Time	00:00:00...23:59:59	s	1 = 1 s
34.31	Timer 7 duration	Duration	00 00:00...07 00:00	min	1 = 1 min
34.32	Timer 8 configuration	<i>PB</i>	0000h...FFFFh	-	1 = 1
34.33	Timer 8 start time	Time	00:00:00...23:59:59	s	1 = 1 s
34.34	Timer 8 duration	Duration	00 00:00...07 00:00	min	1 = 1 min
34.35	Timer 9 configuration	<i>PB</i>	0000h...FFFFh	-	1 = 1
34.36	Timer 9 start time	Time	00:00:00...23:59:59	s	1 = 1 s
34.37	Timer 9 duration	Duration	00 00:00...07 00:00	min	1 = 1 min
34.38	Timer 10 configuration	<i>PB</i>	0000h...FFFFh	-	1 = 1
34.39	Timer 10 start time	Time	00:00:00...23:59:59	s	1 = 1 s
34.40	Timer 10 duration	Duration	00 00:00...07 00:00	min	1 = 1 min
34.41	Timer 11 configuration	<i>PB</i>	0000h...FFFFh	-	1 = 1
34.42	Timer 11 start time	Time	00:00:00...23:59:59	s	1 = 1 s
34.43	Timer 11 duration	Duration	00 00:00...07 00:00	min	1 = 1 min
34.44	Timer 12 configuration	<i>PB</i>	0000h...FFFFh	-	1 = 1
34.45	Timer 12 start time	Time	00:00:00...23:59:59	s	1 = 1 s
34.46	Timer 12 duration	Duration	00 00:00...07 00:00	min	1 = 1 min
34.60	Season 1 start date	Date	01.01...31.12	d	1 = 1 d
34.61	Season 2 start date	Date	01.01...31.12	d	1 = 1 d
34.62	Season 3 start date	Date	01.01...31.12	d	1 = 1 d

No.	Name	Type	Range	Unit	FbEq32
34.63	Season 4 start date	Date	01.01...31.12	d	1 = 1 d
34.70	Number of active exceptions	<i>Real</i>	0...16	-	1 = 1
34.71	Exception types	<i>PB</i>	0000h...FFFFh	-	1 = 1
34.72	Exception 1 start	Date	01.01...31.12	d	1 = 1 d
34.73	Exception 1 length	<i>Real</i>	0...60	d	1 = 1 d
34.74	Exception 2 start	Date	01.01...31.12	d	1 = 1 d
34.75	Exception 2 length	<i>Real</i>	0...60	d	1 = 1 d
34.76	Exception 3 start	Date	01.01...31.12	d	1 = 1 d
34.77	Exception 3 length	<i>Real</i>	0...60	d	1 = 1 d
34.78	Exception day 4	Date	01.01...31.12	d	1 = 1 d
34.79	Exception day 5	Date	01.01...31.12	d	1 = 1 d
34.80	Exception day 6	Date	01.01...31.12	d	1 = 1 d
34.81	Exception day 7	Date	01.01...31.12	d	1 = 1 d
34.82	Exception day 8	Date	01.01...31.12	d	1 = 1 d
34.83	Exception day 9	Date	01.01...31.12	d	1 = 1 d
34.84	Exception day 10	Date	01.01...31.12	d	1 = 1 d
34.85	Exception day 11	Date	01.01...31.12	d	1 = 1 d
34.86	Exception day 12	Date	01.01...31.12	d	1 = 1 d
34.87	Exception day 13	Date	01.01...31.12	d	1 = 1 d
34.88	Exception day 14	Date	01.01...31.12	d	1 = 1 d
34.89	Exception day 15	Date	01.01...31.12	d	1 = 1 d
34.90	Exception day 16	Date	01.01...31.12	d	1 = 1 d
34.100	Timed function 1	<i>PB</i>	0000h...FFFFh	-	1 = 1
34.101	Timed function 2	<i>PB</i>	0000h...FFFFh	-	1 = 1
34.102	Timed function 3	<i>PB</i>	0000h...FFFFh	-	1 = 1
34.110	Boost time function	<i>PB</i>	0000h...FFFFh	-	1 = 1
34.111	Boost time activation source	<i>Binary src</i>	-	-	1 = 1
34.112	Boost time duration	Duration	00 00:00...07 00:00	min	1 = 1 min
35 Motor thermal protection					
35.01	Motor estimated temperature	<i>Real</i>	-60...1000 °C or -76...1832 °F	°C or °F	1 = 1 unit
35.02	Measured temperature 1	<i>Real</i>	-60...5000 °C or -76...9032 °F, 0 ohm or [35.12] ohm	°C, °F or ohm	1 = 1 unit
35.03	Measured temperature 2	<i>Real</i>	-60...5000 °C or -76...9032 °F, 0 ohm or [35.12] ohm	°C, °F or ohm	1 = 1 unit
35.05	Motor overload level	<i>Real</i>	0.0...100.0%	%	100 = 1%
35.11	Temperature 1 source	<i>List</i>	0...2, 5...8, 11...16, 19...20, 21...23	-	1 = 1

No.	Name	Type	Range	Unit	FbEq32
35.12	Temperature 1 fault limit	<i>Real</i>	-60...5000 °C or -76...9032 °F	°C, °F or ohm	1 = 1 unit
35.13	Temperature 1 warning limit	<i>Real</i>	-60...5000 °C or -76...9032 °F	°C, °F or ohm	1 = 1 unit
35.14	Temperature 1 AI source	<i>Analog src</i>	-	-	1 = 1
35.21	Temperature 2 source	<i>List</i>	0...2, 5...8, 11...16, 19...20, 21...23	-	1 = 1
35.22	Temperature 2 fault limit	<i>Real</i>	-60...5000 °C or -76...9032 °F	°C, °F or ohm	1 = 1 unit
35.23	Temperature 2 warning limit	<i>Real</i>	-60...5000 °C or -76...9032 °F	°C, °F or ohm	1 = 1 unit
35.24	Temperature 2 AI source	<i>Analog src</i>	-	-	1 = 1
35.31	Safe motor temperature enable	<i>List</i>	0...1	-	1 = 1
35.50	Motor ambient temperature	<i>Real</i>	-60...100 °C or -76 ... 212 °F	°C or °F	1 = 1 unit
35.51	Motor load curve	<i>Real</i>	50...150	%	1 = 1%
35.52	Zero speed load	<i>Real</i>	25...150	%	1 = 1%
35.53	Break point	<i>Real</i>	1.00 ... 500.00	Hz	100 = 1 Hz
35.54	Motor nominal temperature rise	<i>Real</i>	0...300 °C or 32...572 °F	°C or °F	1 = 1 unit
35.55	Motor thermal time constant	<i>Real</i>	100...10000	s	1 = 1 s
35.56	Motor overload action	<i>List</i>	0...2	-	1 = 1
35.57	Motor overload class	<i>List</i>	0...5	-	1 = 1
36 Load analyzer					
36.01	PVL signal source	<i>Analog src</i>	-	-	1 = 1
36.02	PVL filter time	<i>Real</i>	0.00...120.00	s	100 = 1 s
36.06	AL2 signal source	<i>Analog src</i>	-	-	1 = 1
36.07	AL2 signal scaling	<i>Real</i>	0.00...32767.00	-	100 = 1
36.09	Reset loggers	<i>List</i>	0...3	-	1 = 1
36.10	PVL peak value	<i>Real</i>	-32768.00...32767.00	-	100 = 1
36.11	PVL peak date	<i>Data</i>	-	-	1 = 1
36.12	PVL peak time	<i>Data</i>	-	-	1 = 1
36.13	PVL current at peak	<i>Real</i>	-32768.00...32767.00	A	100 = 1 A
36.14	PVL DC voltage at peak	<i>Real</i>	0.00...2000.00	V	100 = 1 V
36.15	PVL speed at peak	<i>Real</i>	-30000.00... 30000.00	rpm	100 = 1 rpm
36.16	PVL reset date	<i>Data</i>	-	-	1 = 1
36.17	PVL reset time	<i>Data</i>	-	-	1 = 1
36.20	AL1 0 to 10%	<i>Real</i>	0.00...100.00	%	100 = 1%
36.21	AL1 10 to 20%	<i>Real</i>	0.00...100.00	%	100 = 1%
36.22	AL1 20 to 30%	<i>Real</i>	0.00...100.00	%	100 = 1%

No.	Name	Type	Range	Unit	FbEq32
36.23	AL1 30 to 40%	<i>Real</i>	0.00...100.00	%	100 = 1%
36.24	AL1 40 to 50%	<i>Real</i>	0.00...100.00	%	100 = 1%
36.25	AL1 50 to 60%	<i>Real</i>	0.00...100.00	%	100 = 1%
36.26	AL1 60 to 70%	<i>Real</i>	0.00...100.00	%	100 = 1%
36.27	AL1 70 to 80%	<i>Real</i>	0.00...100.00	%	100 = 1%
36.28	AL1 80 to 90%	<i>Real</i>	0.00...100.00	%	100 = 1%
36.29	AL1 over 90%	<i>Real</i>	0.00...100.00	%	100 = 1%
36.40	AL2 0 to 10%	<i>Real</i>	0.00...100.00	%	100 = 1%
36.41	AL2 10 to 20%	<i>Real</i>	0.00...100.00	%	100 = 1%
36.42	AL2 20 to 30%	<i>Real</i>	0.00...100.00	%	100 = 1%
36.43	AL2 30 to 40%	<i>Real</i>	0.00...100.00	%	100 = 1%
36.44	AL2 40 to 50%	<i>Real</i>	0.00...100.00	%	100 = 1%
36.45	AL2 50 to 60%	<i>Real</i>	0.00...100.00	%	100 = 1%
36.46	AL2 60 to 70%	<i>Real</i>	0.00...100.00	%	100 = 1%
36.47	AL2 70 to 80%	<i>Real</i>	0.00...100.00	%	100 = 1%
36.48	AL2 80 to 90%	<i>Real</i>	0.00...100.00	%	100 = 1%
36.49	AL2 over 90%	<i>Real</i>	0.00...100.00	%	100 = 1%
36.50	AL2 reset date	<i>Data</i>	-	-	1 = 1
36.51	AL2 reset time	<i>Data</i>	-	-	1 = 1
37 User load curve					
37.01	ULC output status word	<i>PB</i>	0000h...FFFFh	-	1 = 1
37.02	ULC supervision signal	<i>Analog src</i>	-	-	1 = 1
37.03	ULC overload actions	<i>List</i>	0...3	-	1 = 1
37.04	ULC underload actions	<i>List</i>	0...3	-	1 = 1
37.11	ULC speed table point 1	<i>Real</i>	-30000.0...30000.0	rpm	10 = 1 rpm
37.12	ULC speed table point 2	<i>Real</i>	-30000.0...30000.0	rpm	10 = 1 rpm
37.13	ULC speed table point 3	<i>Real</i>	-30000.0...30000.0	rpm	10 = 1 rpm
37.14	ULC speed table point 4	<i>Real</i>	-30000.0...30000.0	rpm	10 = 1 rpm
37.15	ULC speed table point 5	<i>Real</i>	-30000.0...30000.0	rpm	10 = 1 rpm
37.16	ULC frequency table point 1	<i>Real</i>	-500.0...500.0	Hz	10 = 1 Hz
37.17	ULC frequency table point 2	<i>Real</i>	-500.0...500.0	Hz	10 = 1 Hz
37.18	ULC frequency table point 3	<i>Real</i>	-500.0...500.0	Hz	10 = 1 Hz
37.19	ULC frequency table point 4	<i>Real</i>	-500.0...500.0	Hz	10 = 1 Hz
37.20	ULC frequency table point 5	<i>Real</i>	-500.0...500.0	Hz	10 = 1 Hz
37.21	ULC underload point 1	<i>Real</i>	-1600.0...1600.0	%	10 = 1%
37.22	ULC underload point 2	<i>Real</i>	-1600.0...1600.0	%	10 = 1%
37.23	ULC underload point 3	<i>Real</i>	-1600.0...1600.0	%	10 = 1%
37.24	ULC underload point 4	<i>Real</i>	-1600.0...1600.0	%	10 = 1%
37.25	ULC underload point 5	<i>Real</i>	-1600.0...1600.0	%	10 = 1%
37.31	ULC overload point 1	<i>Real</i>	-1600.0...1600.0	%	10 = 1%

No.	Name	Type	Range	Unit	FbEq32
37.32	ULC overload point 2	<i>Real</i>	-1600.0...1600.0	%	10 = 1%
37.33	ULC overload point 3	<i>Real</i>	-1600.0...1600.0	%	10 = 1%
37.34	ULC overload point 4	<i>Real</i>	-1600.0...1600.0	%	10 = 1%
37.35	ULC overload point 5	<i>Real</i>	-1600.0...1600.0	%	10 = 1%
37.41	ULC overload timer	<i>Real</i>	0.0...10000.0	s	10 = 1 s
37.42	ULC underload timer	<i>Real</i>	0.0...10000.0	s	10 = 1 s
40 Process PID set 1					
40.01	Process PID output actual	<i>Real</i>	-200000.00...200000.00	%	100 = 1 %
40.02	Process PID feedback actual	<i>Real</i>	-200000.00...200000.00	PID unit 1	100 = 1 PID unit 1
40.03	Process PID setpoint actual	<i>Real</i>	-200000...200000	PID unit 1	100 = 1 PID unit 1
40.04	Process PID deviation actual	<i>Real</i>	-200000.00...200000.00	PID unit 1	100 = 1 PID unit 1
40.06	Process PID status word	<i>PB</i>	0000h...FFFFh	-	1 = 1
40.07	Process PID operation mode	<i>List</i>	0...2	-	1 = 1
40.08	Set 1 feedback 1 source	<i>Analog src</i>	-	-	1 = 1
40.09	Set 1 feedback 2 source	<i>Analog src</i>	-	-	1 = 1
40.10	Set 1 feedback function	<i>List</i>	0...13	-	1 = 1
40.11	Set 1 feedback filter time	<i>Real</i>	0.000...30.000	s	1000 = 1 s
40.14	Set 1 setpoint scaling	<i>Real</i>	-200000.00...200000.00	-	100 = 1
40.15	Set 1 output scaling	<i>Real</i>	-200000.00...200000.00	-	100 = 1
40.16	Set 1 setpoint 1 source	<i>Analog src</i>	-	-	1 = 1
40.17	Set 1 setpoint 2 source	<i>Analog src</i>	-	-	1 = 1
40.18	Set 1 setpoint function	<i>List</i>	0...13	-	1 = 1
40.19	Set 1 internal setpoint sel1	<i>Binary src</i>	-	-	1 = 1
40.20	Set 1 internal setpoint sel2	<i>Binary src</i>	-	-	1 = 1
40.21	Set 1 internal setpoint 1	<i>Real</i>	-200000.00...200000.00	PID unit 1	100 = 1 PID unit 1
40.22	Set 1 internal setpoint 2	<i>Real</i>	-200000.00...200000.00	PID unit 1	100 = 1 PID unit 1
40.23	Set 1 internal setpoint 3	<i>Real</i>	-200000.00...200000.00	PID unit 1	100 = 1 PID unit 1
40.24	Set 1 internal setpoint 0	<i>Real</i>	-200000.00...200000.00	PID unit 1	100 = 1 PID unit 1
40.26	Set 1 setpoint min	<i>Real</i>	-200000.00...200000.00	PID unit 1	100 = 1 PID unit 1
40.27	Set 1 setpoint max	<i>Real</i>	-200000.00...200000.00	PID unit 1	100 = 1 PID unit 1
40.28	Set 1 setpoint increase time	<i>Real</i>	0.0...1800.0	s	10 = 1 s

No.	Name	Type	Range	Unit	FbEq32
40.29	Set 1 setpoint decrease time	<i>Real</i>	0.0...1800.0	s	10 = 1 s
40.30	Set 1 setpoint freeze enable	<i>Binary src</i>	-	-	1 = 1
40.31	Set 1 deviation inversion	<i>Binary src</i>	-	-	1 = 1
40.32	Set 1 gain	<i>Real</i>	0.10...100.00	-	100 = 1
40.33	Set 1 integration time	<i>Real</i>	0.0...9999.0	s	10 = 1 s
40.34	Set 1 derivation time	<i>Real</i>	0.000...10.000	s	1000 = 1 s
40.35	Set 1 derivation filter time	<i>Real</i>	0.0...10.0	s	10 = 1 s
40.36	Set 1 output min	<i>Real</i>	-200000.00...200000.00	-	100 = 1
40.37	Set 1 output max	<i>Real</i>	-200000.00...200000.00	-	100 = 1
40.38	Set 1 output freeze enable	<i>Binary src</i>	-	-	1 = 1
40.39	Set 1 deadband range	<i>Real</i>	0...200000.0	-	10 = 1
40.40	Set 1 deadband delay	<i>Real</i>	0.0...3600.0	s	10 = 1 s
40.43	Set 1 sleep level	<i>Real</i>	0.0...200000.0	-	10 = 1
40.44	Set 1 sleep delay	<i>Real</i>	0.0...3600.0	s	10 = 1 s
40.45	Set 1 sleep boost time	<i>Real</i>	0.0...3600.0	s	10 = 1 s
40.46	Set 1 sleep boost step	<i>Real</i>	0.0...200000.0	PID unit 1	100 = 1 PID unit 1
40.47	Set 1 wake-up deviation	<i>Real</i>	-200000.00...200000.00	PID unit 1	100 = 1 PID unit 1
40.48	Set 1 wake-up delay	<i>Real</i>	0.00...60.00	s	100 = 1 s
40.49	Set 1 tracking mode	<i>Binary src</i>	-	-	1 = 1
40.50	Set 1 tracking ref selection	<i>Analog src</i>	-	-	1 = 1
40.57	PID set1/set2 selection	<i>Binary src</i>	-	-	1 = 1
40.58	Set 1 increase prevention	<i>Binary src</i>	-	-	1 = 1
40.59	Set 1 decrease prevention	<i>Binary src</i>	-	-	1 = 1
40.60	Set 1 PID activation source	<i>Binary src</i>	-	-	1 = 1
40.61	Setpoint scaling actual	<i>Real</i>	-200000.00...200000.00	-	100 = 1
40.62	PID internal setpoint actual	<i>Real</i>	-200000.00...200000.00	PID unit 1	100 = 1 PID unit 1
40.70	Compensated setpoint	<i>Real</i>	-21474836.48... 21474835.20	PID unit 1	100 = 1 PID unit 1
40.71	Set 1 compensation input source	<i>List</i>	0, 2...4, 8, 10...12, 15...16, 19...20, 24	-	1 = 1
40.72	Set 1 compensation input 1	<i>Real</i>	-200000.00...200000.00	-	100 = 1
40.73	Set 1 compensated output 1	<i>Real</i>	-200000.00...200000.00	-	100 = 1
40.74	Set 1 compensation input 2	<i>Real</i>	-200000.00...200000.00	-	100 = 1
40.75	Set 1 compensated output 2	<i>Real</i>	-200000.00...200000.00	-	100 = 1

No.	Name	Type	Range	Unit	FbEq32
40.76	Set 1 compensation non-linearity	<i>Real</i>	0...100	%	1= 1%
40.79	Set 1 units	<i>List</i>		-	1 = 1
40.80	Set 1 PID output min source	<i>List</i>	0...1	-	1 = 1
40.81	Set 1 PID output max source	<i>List</i>	0...1	-	1 = 1
40.89	Set 1 setpoint multiplier	<i>Real</i>	-200000.00...200000.00	-	100 = 1
40.90	Set 1 feedback multiplier	<i>Real</i>	-200000.00...200000.00	-	100 = 1
40.91	Feedback data storage	<i>Real</i>	-327.68...327.67	-	100 = 1
40.92	Setpoint data storage	<i>Real</i>	-327.68...327.67	-	100 = 1
40.96	Process PID output %	<i>Real</i>	-100.00...100.00	%	100 = 1%
40.97	Process PID feedback %	<i>Real</i>	-100.00...100.00	%	100 = 1%
40.98	Process PID setpoint %	<i>Real</i>	-100.00...100.00	%	100 = 1%
40.99	Process PID deviation %	<i>Real</i>	-100.00...100.00	%	100 = 1%
41 Process PID set 2					
41.08	Set 2 feedback 1 source	<i>Analog src</i>	-	-	1 = 1
41.09	Set 2 feedback 2 source	<i>Analog src</i>	-	-	1 = 1
41.10	Set 2 feedback function	<i>List</i>	0...13	-	1 = 1
41.11	Set 2 feedback filter time	<i>Real</i>	0.000...30.000	s	1000 = 1 s
41.14	Set 2 setpoint scaling	<i>Real</i>	-200000.00...200000.00	-	100 = 1
41.15	Set 2 output scaling	<i>Real</i>	-200000.00...200000.00	-	100 = 1
41.16	Set 2 setpoint 1 source	<i>Analog src</i>	-	-	1 = 1
41.17	Set 2 setpoint 2 source	<i>Analog src</i>	-	-	1 = 1
41.18	Set 2 setpoint function	<i>List</i>	0...13	-	1 = 1
41.19	Set 2 internal setpoint sel1	<i>Binary src</i>	-	-	1 = 1
41.20	Set 2 internal setpoint sel2	<i>Binary src</i>	-	-	1 = 1
41.21	Set 2 internal setpoint 1	<i>Real</i>	-200000.00...200000.00	PID unit 1	100 = 1 PID unit 1
41.22	Set 2 internal setpoint 2	<i>Real</i>	-200000.00...200000.00	PID unit 1	100 = 1 PID unit 1
41.23	Set 2 internal setpoint 3	<i>Real</i>	-200000.00...200000.00	PID unit 1	100 = 1 PID unit 1
41.24	Set 2 internal setpoint 0	<i>Real</i>	-200000.00...200000.00	PID unit 1	100 = 1 PID unit 1
41.26	Set 2 setpoint min	<i>Real</i>	-200000.00...200000.00	PID unit 1	100 = 1 PID unit 1
41.27	Set 2 setpoint max	<i>Real</i>	-200000.00...200000.00	PID unit 1	100 = 1 PID unit 1
41.28	Set 2 setpoint increase time	<i>Real</i>	0.0...1800.0	s	10 = 1 s
41.29	Set 2 setpoint decrease time	<i>Real</i>	0.0...1800.0	s	10 = 1 s

No.	Name	Type	Range	Unit	FbEq32
41.30	Set 2 setpoint freeze enable	Binary src	-	-	1 = 1
41.31	Set 2 deviation inversion	Binary src	-	-	1 = 1
41.32	Set 2 gain	Real	0.10...100.00	-	100 = 1
41.33	Set 2 integration time	Real	0.0...9999.0	s	10 = 1 s
41.34	Set 2 derivation time	Real	0.000...10.000	s	1000 = 1 s
41.35	Set 2 derivation filter time	Real	0.0...10.0	s	10 = 1 s
41.36	Set 2 output min	Real	-200000.00...200000.00	-	100 = 1
41.37	Set 2 output max	Real	-200000.00...200000.00	-	100 = 1
41.38	Set 2 output freeze enable	Binary src	-	-	1 = 1
41.39	Set 2 deadband range	Real	0...200000.0	-	10 = 1
41.40	Set 2 deadband delay	Real	0.0...3600.0	s	10 = 1 s
41.43	Set 2 sleep level	Real	0.0...200000.0	-	10 = 1
41.44	Set 2 sleep delay	Real	0.0...3600.0	s	10 = 1 s
41.45	Set 2 sleep boost time	Real	0.0...3600.0	s	10 = 1 s
41.46	Set 2 sleep boost step	Real	0.0...200000.0	PID unit 1	10 = 1 PID unit 1
41.47	Set 2 wake-up deviation	Real	-200000.00...200000.00	PID unit 1	100 = 1 PID unit 1
41.48	Set 2 wake-up delay	Real	0.00...60.00	s	100 = 1 s
41.49	Set 2 tracking mode	Binary src	-	-	1 = 1
41.50	Set 2 tracking ref selection	Analog src	-	-	1 = 1
41.58	Set 2 increase prevention	Binary src	-	-	1 = 1
41.59	Set 2 decrease prevention	Binary src	-	-	1 = 1
41.60	Set 2 PID activation source	Binary src	-	-	1 = 1
41.71	Set 2 compensation input source	List	0, 2...4, 8, 10...12, 15...16, 19...20, 24	-	1 = 1
41.72	Set 2 compensation input 1	Real	-200000.00...200000.00	-	100 = 1
41.73	Set 2 compensated output 1	Real	-200000.00...200000.00	-	100 = 1
41.74	Set 2 compensation input 2	Real	-200000.00...200000.00	-	100 = 1
41.75	Set 2 compensated output 2	Real	-200000.00...200000.00	-	100 = 1
41.76	Set 2 compensation non-linearity	Real	0...100	%	1 = 1%
41.79	Set 2 units	List		-	1 = 1
41.80	Set 2 PID output min source	List	0...1	-	1 = 1
41.81	Set 2 PID output max source	List	0...1	-	1 = 1
41.89	Set 2 setpoint multiplier	Real	-200000.00...200000.00	-	100 = 1
41.90	Set 2 feedback multiplier	Real	-200000.00...200000.00	-	100 = 1

No.	Name	Type	Range	Unit	FbEq32
43 Brake chopper					
43.01	Braking resistor temperature	<i>Real</i>	0.0...120.0	%	10 = 1%
43.06	Brake chopper function	<i>List</i>	0...3	-	1 = 1
43.07	Brake chopper run enable	<i>Binary src</i>	-	-	1 = 1
43.08	Brake resistor thermal tc	<i>Real</i>	0...10000	s	1 = 1 s
43.09	Brake resistor Pmax cont	<i>Real</i>	0.00...10000.00	kW	100 = 1 kW
43.10	Brake resistance	<i>Real</i>	0.0...1000.0	ohm	10 = 1 ohm
43.11	Brake resistor fault limit	<i>Real</i>	0...150	%	1 = 1%
43.12	Brake resistor warning limit	<i>Real</i>	0...150	%	1 = 1%
45 Energy efficiency					
45.01	Saved GW hours	<i>Real</i>	0...65535	GWh	1 = 1 GWh
45.02	Saved MW hours	<i>Real</i>	0...999	MWh	1 = 1 MWh
45.03	Saved kW hours	<i>Real</i>	0.0...999.9	kWh	10 = 1 kWh
45.04	Saved energy	<i>Real</i>	0.0...214748364.0	kWh	10 = 1 kWh
45.05	Saved money x1000	<i>Real</i>	0...4294967295 thousands	(defina- ble)	1 = 1 currency unit
45.06	Saved money	<i>Real</i>	0.00...999.99	(defina- ble)	100 = 1 currency unit
45.07	Saved amount	<i>Real</i>	0.00...21474830.08	(defina- ble)	100 = 1 currency unit
45.08	CO2 reduction in kilotons	<i>Real</i>	0...65535	metric kiloton	1 = 1 metric kiloton
45.09	CO2 reduction in tons	<i>Real</i>	0.0...999.9	metric ton	10 = 1 metric ton
45.10	Total saved CO2	<i>Real</i>	0.0...214748300.8	metric ton	10 = 1 metric ton
45.11	Energy optimizer	<i>List</i>	0...1	-	1 = 1
45.12	Energy tariff 1	<i>Real</i>	0.000...4294966.296	(defina- ble)	1000 = 1 currency unit
45.13	Energy tariff 2	<i>Real</i>	0.000...4294966.296	(defina- ble)	1000 = 1 currency unit
45.14	Tariff selection	<i>Binary src</i>	-	-	1 = 1
45.18	CO2 conversion factor	<i>Real</i>	0.000...65.535	tn/ MWh	1000 = 1 tn/MWh
45.19	Comparison power	<i>Real</i>	0.00...10000000.00	kW	10 = 1 kW
45.21	Energy calculations reset	<i>List</i>	0...1	-	1 = 1
45.24	Hourly peak power value	<i>Real</i>	-3000.00...3000.00	kW	1 = 1 kW
45.25	Hourly peak power time	<i>Real</i>			N/A
45.26	Hourly total energy (resettable)	<i>Real</i>	-3000.00...3000.00	kWh	1 = 1 kWh
45.27	Daily peak power value (resettable)	<i>Real</i>	-3000.00...3000.00	kW	1 = 1 kW

No.	Name	Type	Range	Unit	FbEq32
45.28	Daily peak power time	<i>Real</i>			N/A
45.29	Daily total energy (resettable)	<i>Real</i>	-30000.00...30000.00	kWh	1 = 1 kWh
45.30	Last day total energy	<i>Real</i>	-30000.00...30000.00	kWh	1 = 1 kWh
45.31	Monthly peak power value (resettable)	<i>Real</i>	-30000.00...30000.00	kW	1 = 1 kW
45.32	Monthly peak power date	<i>Real</i>			N/A
45.33	Monthly peak power time	<i>Real</i>			N/A
45.34	Monthly total energy (resettable)	<i>Real</i>	-1000000.00...1000000.00	kWh	1 = 1 kWh
45.35	Last month total energy	<i>Real</i>	-1000000.00...1000000.00	kWh	1 = 1 kWh
45.36	Lifetime peak power value	<i>Real</i>	-3000.00...3000.00	kW	1 = 1 kW
45.37	Lifetime peak power date	<i>Real</i>			N/A
45.38	Lifetime peak power time	<i>Real</i>			N/A
46 Monitoring/scaling settings					
46.01	Speed scaling	<i>Real</i>	0.00...30000.00	rpm	100 = 1 rpm
46.02	Frequency scaling	<i>Real</i>	0.10...1000.00	Hz	100 = 1 Hz
46.03	Torque scaling	<i>Real</i>	0.1...1000.0	%	10 = 1%
46.04	Power scaling	<i>Real</i>	0.10...30000.00 kW or hp	kW or hp	10 = 1 unit
46.05	Current scaling	<i>Real</i>	0...30000	A	1 = 1 A
46.06	Speed ref zero scaling	<i>Real</i>	0.00...30000.00	rpm	100 = 1 rpm
46.07	Frequency ref zero scaling	<i>Real</i>	0.00...1000.00	Hz	100 = 1 Hz
46.11	Filter time motor speed	<i>Real</i>	2...20000	ms	1 = 1 ms
46.12	Filter time output frequency	<i>Real</i>	2...20000	ms	1 = 1 ms
46.13	Filter time motor torque	<i>Real</i>	2...20000	ms	1 = 1 ms
46.14	Filter time power	<i>Real</i>	2...20000	ms	1 = 1 ms
46.21	At speed hysteresis	<i>Real</i>	0.00...30000.00	rpm	100 = 1 rpm
46.22	At frequency hysteresis	<i>Real</i>	0.00...1000.00	Hz	100 = 1 Hz
46.31	Above speed limit	<i>Real</i>	0.00...30000.00	rpm	100 = 1 rpm
46.32	Above frequency limit	<i>Real</i>	0.00...1000.00	Hz	100 = 1 Hz
46.41	kWh pulse scaling	<i>Real</i>	0.001...1000.000	kWh	1000 = 1 kWh
46.43	Power decimals	<i>Real</i>	0...3	-	1 = 1
46.44	Current decimals	<i>Real</i>	0...3	-	1 = 1
47 Data storage					
47.01	Data storage 1 real32	<i>Real</i>	-2147483.000... 2147483.000	-	1000 = 1
47.02	Data storage 2 real32	<i>Real</i>	-2147483.000... 2147483.000	-	1000 = 1
47.03	Data storage 3 real32	<i>Real</i>	-2147483.000... 2147483.000	-	1000 = 1
47.04	Data storage 4 real32	<i>Real</i>	-2147483.000... 2147483.000	-	1000 = 1
47.11	Data storage 1 int32	<i>Real</i>	-2147483648... 2147483647	-	1 = 1

No.	Name	Type	Range	Unit	FbEq32
47.12	Data storage 2 int32	<i>Real</i>	-2147483648... 2147483647	-	1 = 1
47.13	Data storage 3 int32	<i>Real</i>	-2147483648... 2147483647	-	1 = 1
47.14	Data storage 4 int32	<i>Real</i>	-2147483648... 2147483647	-	1 = 1
47.21	Data storage 1 int16	<i>Real</i>	-32768...32767	-	1 = 1
47.22	Data storage 2 int16	<i>Real</i>	-32768...32767	-	1 = 1
47.23	Data storage 3 int16	<i>Real</i>	-32768...32767	-	1 = 1
47.24	Data storage 4 int16	<i>Real</i>	-32768...32767	-	1 = 1
49 Panel port communication					
49.01	Node ID number	<i>Real</i>	1...32	-	1 = 1
49.03	Baud rate	<i>List</i>	1...5	-	1 = 1
49.04	Communication loss time	<i>Real</i>	0.3...3000.0	s	10 = 1 s
49.05	Communication loss action	<i>List</i>	0...3	-	1 = 1
49.06	Refresh settings	<i>List</i>	0...1	-	1 = 1
50 Fieldbus adapter (FBA)					
50.01	FBA A enable	<i>List</i>	0...1	-	1 = 1
50.02	FBA A comm loss func	<i>List</i>	0...5	-	1 = 1
50.03	FBA A comm loss t out	<i>Real</i>	0.3...6553.5	s	10 = 1 s
50.04	FBA A ref1 type	<i>List</i>	0...0...2, 4...5	-	1 = 1
50.05	FBA A ref2 type	<i>List</i>	0...0...2, 4...5	-	1 = 1
50.06	FBA A SW sel	<i>List</i>	0...1	-	1 = 1
50.07	FBA A actual 1 type	<i>List</i>	0...0...2, 4...5	-	1 = 1
50.08	FBA A actual 2 type	<i>List</i>	0...0...2, 4...5	-	1 = 1
50.09	FBA A SW transparent source	<i>Analog src</i>	-	-	1 = 1
50.10	FBA A act1 transparent source	<i>Analog src</i>	-	-	1 = 1
50.11	FBA A act2 transparent source	<i>Analog src</i>	-	-	1 = 1
50.12	FBA A debug mode	<i>List</i>	0...1	-	1 = 1
50.13	FBA A control word	<i>Data</i>	00000000h...FFFFFFFh	-	1 = 1
50.14	FBA A reference 1	<i>Real</i>	-2147483648... 2147483647	-	1 = 1
50.15	FBA A reference 2	<i>Real</i>	-2147483648... 2147483647	-	1 = 1
50.16	FBA A status word	<i>Data</i>	00000000h...FFFFFFFh	-	1 = 1
50.17	FBA A actual value 1	<i>Real</i>	-2147483648... 2147483647	-	1 = 1
50.18	FBA A actual value 2	<i>Real</i>	-2147483648... 2147483647	-	1 = 1
51 FBA A settings					
51.01	FBA A type	<i>List</i>	-	-	1 = 1

No.	Name	Type	Range	Unit	FbEq32
51.02	FBA A Par2	<i>Real</i>	0...65535	-	1 = 1
...	
51.26	FBA A Par26	<i>Real</i>	0...65535	-	1 = 1
51.27	FBA A par refresh	<i>List</i>	0...1	-	1 = 1
51.28	FBA A par table ver	<i>Data</i>	-	-	1 = 1
51.29	FBA A drive type code	<i>Real</i>	0...65535	-	1 = 1
51.30	FBA A mapping file ver	<i>Real</i>	0...65535	-	1 = 1
51.31	D2FBA A comm status	<i>List</i>	0...6	-	1 = 1
51.32	FBA A comm SW ver	<i>Data</i>	-	-	1 = 1
51.33	FBA A appl SW ver	<i>Data</i>	-	-	1 = 1
52 FBA A data in					
52.01	FBA A data in1	<i>List</i>	-	-	1 = 1
...	
52.12	FBA A data in12	<i>List</i>	-	-	1 = 1
53 FBA A data out					
53.01	FBA A data out1	<i>List</i>	-	-	1 = 1
...	
53.12	FBA A data out12	<i>List</i>	-	-	1 = 1
58 Embedded fieldbus					
58.01	Protocol enable	<i>List</i>	, 0...1, 4	-	1 = 1
58.02	Protocol ID	<i>Real</i>	0000h...FFFFh	-	1 = 1
58.03	Node address	<i>Real</i>	0...255	-	1 = 1
58.04	Baud rate	<i>List</i>	0...7	-	1 = 1
58.05	Parity	<i>List</i>	0...3	-	1 = 1
58.06	Communication control	<i>List</i>	0...2	-	1 = 1
58.07	Communication diagnostics	<i>PB</i>	0000h...FFFFh	-	1 = 1
58.08	Received packets	<i>Real</i>	0...4294967295	-	1 = 1
58.09	Transmitted packets	<i>Real</i>	0...4294967295	-	1 = 1
58.10	All packets	<i>Real</i>	0...4294967295	-	1 = 1
58.11	UART errors	<i>Real</i>	0...4294967295	-	1 = 1
58.12	CRC errors	<i>Real</i>	0...4294967295	-	1 = 1
58.14	Communication loss action	<i>List</i>	0...5	-	1 = 1
58.15	Communication loss mode	<i>List</i>	1...2	-	1 = 1
58.16	Communication loss time	<i>Real</i>	0.0...6000.0	s	10 = 1 s
58.17	Transmit delay	<i>Real</i>	0...65535	ms	1 = 1 ms
58.18	EFB control word	<i>PB</i>	00000000h...FFFFFFFFh	-	1 = 1
58.19	EFB status word	<i>PB</i>	00000000h...FFFFFFFFh	-	1 = 1
58.25	Control profile	<i>List</i>	0, 5	-	1 = 1
58.26	EFB ref1 type	<i>List</i>	0...2, 4...5	-	1 = 1
58.27	EFB ref2 type	<i>List</i>	0...2, 4...5	-	1 = 1
58.28	EFB act1 type	<i>List</i>	0...2, 4...5	-	1 = 1

No.	Name	Type	Range	Unit	FbEq32
58.29	EFB act2 type	<i>List</i>	0...2, 4...5	-	1 = 1
58.31	EFB act1 transparent source	<i>Analog src</i>	-	-	1 = 1
58.32	EFB act2 transparent source	<i>Analog src</i>	-	-	1 = 1
58.33	Addressing mode	<i>List</i>	0...2	-	1 = 1
58.34	Word order	<i>List</i>	0...1	-	1 = 1
58.101	Data I/O 1	<i>Analog src</i>	-	-	1 = 1
58.102	Data I/O 2	<i>Analog src</i>	-	-	1 = 1
58.103	Data I/O 3	<i>Analog src</i>	-	-	1 = 1
58.104	Data I/O 4	<i>Analog src</i>	-	-	1 = 1
58.105	Data I/O 5	<i>Analog src</i>	-	-	1 = 1
58.106	Data I/O 6	<i>Analog src</i>	-	-	1 = 1
58.107	Data I/O 7	<i>Analog src</i>	-	-	1 = 1
...	
58.114	Data I/O 14	<i>Analog src</i>	-	-	1 = 1
60 DDCS communication					
<i>(Parameters 60.78...60.79 only visible for ACQ580-31 and ACQ580-34)</i>					
60.78	INU-LSU comm loss timeout	<i>Real</i>	0...65535	ms	-
60.79	INU-LSU comm loss function	<i>Binary src</i>	-	-	1 = 1
61 D2D and DDCS transmit data					
<i>(Parameters 61.201...61.203 only visible for ACQ580-31 and ACQ580-34)</i>					
61.201	INU-LSU data set 10 data 1 value	<i>Real</i>	0...65535	-	-
61.202	INU-LSU data set 10 data 2 value	<i>Real</i>	0...65535	-	-
61.203	INU-LSU data set 10 data 3 value	<i>Real</i>	0...65535	-	-
62 D2D and DDCS receive data					
<i>(Parameter 62.201 only visible for ACQ580-31 and ACQ580-34)</i>					
62.201	INU-LSU data set 11 data 1 value	<i>Real</i>	0...65535	-	-
71 External PID1					
71.01	External PID act value	<i>Real</i>	-200000.00...200000.00	%	100 = 1%
71.02	Feedback act value	<i>Real</i>	-200000.00...200000.00	PID unit 1	100 = 1 PID unit 1

No.	Name	Type	Range	Unit	FbEq32
71.03	Setpoint act value	<i>Real</i>	-200000.00...200000.00	PID unit 1	100 = 1 PID unit 1
71.04	Deviation act value	<i>Real</i>	-200000.00...200000.00	PID unit 1	100 = 1 PID unit 1
71.06	PID status word	<i>PB</i>	0000h...FFFFh	-	1 = 1
71.07	PID operation mode	<i>List</i>	0...2	-	1 = 1
71.08	Feedback 1 source	<i>Analog src</i>	-	-	1 = 1
71.11	Feedback filter time	<i>Real</i>	0.000...30.000	s	1000 = 1 s
71.14	Setpoint scaling	<i>Real</i>	-200000.00...200000.00	-	100 = 1
71.15	Output scaling	<i>Real</i>	-200000.00...200000.00	-	100 = 1
71.16	Setpoint 1 source	<i>Analog src</i>	-	-	1 = 1
71.19	Internal setpoint sel1	<i>Binary src</i>	-	-	1 = 1
71.20	Internal setpoint sel2	<i>Binary src</i>	-	-	1 = 1
71.21	Internal setpoint 1	<i>Real</i>	-200000.00...200000.00	PID unit 1	100 = 1 PID unit 1
71.22	Internal setpoint 2	<i>Real</i>	-200000.00...200000.00	PID unit 1	100 = 1 PID unit 1
71.23	Internal setpoint 3	<i>Real</i>	-200000.00...200000.00	PID unit 1	100 = 1 PID unit 1
71.26	Setpoint min	<i>Real</i>	-200000.00...200000.00	-	100 = 1
71.27	Setpoint max	<i>Real</i>	-200000.00...200000.00	-	100 = 1
71.31	Deviation inversion	<i>Binary src</i>	-	-	1 = 1
71.32	Gain	<i>Real</i>	0.10...100.00	-	100 = 1
71.33	Integration time	<i>Real</i>	0.0...9999.0	s	10 = 1 s
71.34	Derivation time	<i>Real</i>	0.000...10.000	s	1000 = 1 s
71.35	Derivation filter time	<i>Real</i>	0.0...10.0	s	10 = 1 s
71.36	Output min	<i>Real</i>	-200000.00...200000.00	-	10 = 1
71.37	Output max	<i>Real</i>	-200000.00...200000.00	-	10 = 1
71.38	Output freeze enable	<i>Binary src</i>	-	-	1 = 1
71.39	Deadband range	<i>Real</i>	0.0...200000.0	-	10 = 1
71.40	Deadband delay	<i>Real</i>	0.0...3600.0	s	10 = 1 s
71.58	Increase prevention	<i>Binary src</i>	-	-	1 = 1
71.59	Decrease prevention	<i>Binary src</i>	-	-	1 = 1
71.62	Internal setpoint actual	<i>Real</i>	-200000.00...200000.00	PID unit 1	100 = 1 PID unit 1
71.79	External PID units	<i>List</i>	-	-	1 = 1
76 Multipump configuration					
76.01	PFC status	<i>PB</i>	0000h...FFFFh	-	1 = 1

No.	Name	Type	Range	Unit	FbEq32
76.02	Multipump system status	List	0...3, 100...103, 200...202, 300...302, 400, 500, 600, 700, 800...801, 4...9	-	1 = 1
76.05	Measured level	Real	0.00...32767.00	m	10 = 1
76.06	Measured level %	Real	0...100	%	1 = 1
76.07	LC speed ref	Real	-2147483648...2147483520	Hz	1 = Hz
76.11	Pump status 1	PB	0000h...FFFFh	-	1 = 1
76.12	Pump status 2	PB	0000h...FFFFh	-	1 = 1
76.13	Pump status 3	PB	0000h...FFFFh	-	1 = 1
76.14	Pump status 4	PB	0000h...FFFFh	-	1 = 1
76.15	Pump status 5	PB	0000h...FFFFh	-	1 = 1
76.16	Pump status 6	PB	0000h...FFFFh	-	1 = 1
76.17	Pump status 7	PB	0000h...FFFFh	-	1 = 1
76.18	Pump status 8	PB	0000h...FFFFh	-	1 = 1
76.21	Multipump configuration	List	0, 1...5	-	1 = 1
76.22	Multipump node number	Real	1...8	-	1 = 1
76.23	Master enable	List	0...1	-	1 = 1
76.24	IPC communication port	List	0...1	-	1 = 1
76.25	Number of motors	Real	1...8	-	1 = 1
76.26	Min number of motors allowed	Real	0...8	-	1 = 1
76.27	Max number of motors allowed	Real	1...8	-	1 = 1
76.30	Start point 1	Real	0.00...32767.00	rpm/Hz/m	1 = 1 unit
76.31	Start point 2	Real	0.00...32767.00	rpm/Hz/m	1 = 1 unit
76.32	Start point 3	Real	0.00...32767.00	rpm/Hz/m	1 = 1 unit
76.33	Start point 4	Real	0.00...32767.00	rpm/Hz/m	1 = 1 unit
76.34	Start point 5	Real	0.00...32767.00	rpm/Hz/m	1 = 1 unit
76.35	Start point 6	Real	0.00...32767.00	rpm/Hz/m	1 = 1 unit
76.36	Start point 7	Real	0.00...32767.00	rpm/Hz/m	1 = 1 unit
76.37	Start point 8	Real	0.00...32767.00	rpm/Hz/m	1 = 1 unit
76.41	Stop point 1	Real	0.00...32767.00	rpm/Hz/m	1 = 1 unit
76.42	Stop point 2	Real	0.00...32767.00	rpm/Hz/m	1 = 1 unit
76.43	Stop point 3	Real	0.00...32767.00	rpm/Hz/m	1 = 1 unit
76.44	Stop point 4	Real	0.00...32767.00	rpm/Hz/m	1 = 1 unit
76.45	Stop point 5	Real	0.00...32767.00	rpm/Hz/m	1 = 1 unit
76.46	Stop point 6	Real	0.00...32767.00	rpm/Hz/m	1 = 1 unit
76.47	Stop point 7	Real	0.00...32767.00	rpm/Hz/m	1 = 1 unit
76.48	Stop point 8	Real	0.00...32767.00	rpm/Hz/m	1 = 1 unit
76.50	LC full speed point	Real	0.00...32767.00	m	1 = 1 m
76.51	LC level source	List	-	-	1 = 1
76.52	LC level unit	List	-	-	1 = 1
76.53	LC efficient speed	Real	-2147483648... 2147482147483520	rpm/Hz	1 = 1 unit

No.	Name	Type	Range	Unit	FbEq32
76.54	LC max time at level	<i>Real</i>	0.0...1800.0	h	100 = 1 h
76.55	Start delay	<i>Real</i>	0.00...12600.00	s	100 = 1 s
76.56	Stop delay	<i>Real</i>	0.00...12600.00	s	100 = 1 s
76.57	PFC speed hold on	<i>Real</i>	0.00...1000.00	s	100 = 1 s
76.58	PFC speed hold off	<i>Real</i>	0.00...1000.00	s	100 = 1 s
76.59	PFC contactor delay	<i>Real</i>	0.20...600.00	s	100 = 1 s
76.60	PFC ramp acceleration time	<i>Real</i>	0.00...1800.00	s	100 = 1 s
76.61	PFC ramp deceleration time	<i>Real</i>	0.00...1800.00	s	100 = 1 s
76.62	IPC smooth acceleration time	<i>Real</i>	3.00...1800.00	s	100 = 1 s
76.63	IPC smooth deceleration time	<i>Real</i>	3.00...1800.00	s	100 = 1 s
76.70	PFC Autochange	<i>List</i>	-	-	1 = 1
76.71	PFC Autochange interval	<i>Real</i>	0.00...42949672.95	h	100 = 1 h
76.72	Maximum wear imbalance	<i>Real</i>	0.00...1000000.00	h	100 = 1 h
76.73	Autochange level	<i>Real</i>	0.0...300.0	%	10 = 1%
76.74	Autochange auxiliary PFC	<i>List</i>	-	-	-
76.76	Max stationary time	<i>Real</i>	0.0...214748368.0	h	10 = 1 h
76.77	Pump priority	<i>Binary src</i>	-	-	-
76.81	PFC 1 interlock	<i>Binary src</i>	-	-	1 = 1
76.82	PFC 2 interlock	<i>Binary src</i>	-	-	1 = 1
76.83	PFC 3 interlock	<i>Binary src</i>	-	-	1 = 1
76.84	PFC 4 interlock	<i>Binary src</i>	-	-	1 = 1
76.85	PFC 5 interlock	<i>Binary src</i>	-	-	1 = 1
76.86	PFC 6 interlock	<i>Binary src</i>	-	-	1 = 1
76.90	LC low level switch	<i>List</i>	-	-	1 = 1
76.91	LC high level switch	<i>List</i>	-	-	1 = 1
76.92	LC low level action	<i>List</i>	-	-	1 = 1
76.93	LC high level action	<i>List</i>	-	-	1 = 1
76.95	Regulator bypass control	<i>Binary src</i>	-	-	-
76.101	IPC parameter synchronization	<i>Binary src</i>	-	-	-
76.102	IPC synchronization settings	<i>PB</i>	0000h...FFFFh	-	1 = 1
76.105	IPC synchronization checksum	<i>PB</i>	0000h...FFFFh	-	1 = 1
77 Multipump maintenance and monitoring					
77.10	PFC runtime change	<i>List</i>	0...7	-	1 = 1
77.11	Pump 1 running time	<i>Real</i>	0.00...42949672.95	h	100 = 1 h
77.12	Pump 2 running time	<i>Real</i>	0.00...42949672.95	h	100 = 1 h

No.	Name	Type	Range	Unit	FbEq32
77.13	Pump 3 running time	<i>Real</i>	0.00...42949672.95	h	100 = 1 h
77.14	Pump 4 running time	<i>Real</i>	0.00...42949672.95	h	100 = 1 h
77.15	Pump 5 running time	<i>Real</i>	0.00...42949672.95	h	100 = 1 h
77.16	Pump 6 running time	<i>Real</i>	0.00...42949672.95	h	100 = 1 h
77.17	Pump 7 running time	<i>Real</i>	0.00...42949672.95	h	100 = 1 h
77.18	Pump 8 running time	<i>Real</i>	0.00...42949672.95	h	100 = 1 h
77.20	IPC online pumps	<i>PB</i>	0000h...FFFFh	-	1 = 1
77.21	IPC comm loss status	<i>PB</i>	0000h...FFFFh	-	1 = 1
80 Flow calculation					
80.01	Actual flow	<i>Real</i>	-200000.00...200000.00	-	100 = 1
80.02	Actual flow percentage	<i>Real</i>	-100.00...100.00	%	100 = 1
80.03	Total flow	<i>Real</i>	0.00...21474836.00	m ³	100 = 1
80.04	Specific energy	<i>Real</i>	0.00...32767.95	m ³ /kWh	100 = 1
80.05	Estimated pump head	<i>Real</i>	0.00...32767.00	m	100 = 1
80.11	Flow feedback 1 source	<i>List</i>	0...3, 8...10,	-	1 = 1
80.12	Flow feedback 2 source	<i>List</i>	0...3, 8...10,	-	1 = 1
80.13	Flow feedback function	<i>List</i>	0...1, 8...9, 100...101	-	1 = 1
80.14	Flow feedback multiplier	<i>Real</i>	-200000.00...200000.00	-	100 = 1
80.15	Maximum flow	<i>Real</i>	-200000.00...200000.00	-	100 = 1
80.16	Minimum flow	<i>Real</i>	-200000.00...200000.00	m ³ /h	100 = 1
80.17	Maximum flow protection	<i>List</i>	0...3	-	1 = 1
80.18	Minimum flow protection	<i>List</i>	0...3	-	1 = 1
80.19	Flow check delay	<i>Real</i>	0.00...3600.00	s	100 = 1
80.21	Flow pump nominal speed	<i>Real</i>	0.0...30000.0	rpm	1 = 1
80.22	Pump inlet diameter	<i>Real</i>	0.010...32767.000	m	1000 = 1
80.23	Pump outlet diameter	<i>Real</i>	0.010...32767.000	m	1000 = 1
80.26	Calculation minimum speed	<i>Real</i>	0.00...32767.00	Hz	100 = 1
80.28	Density	<i>Real</i>	0.00...32767.00	kg/m ³	
80.29	Total flow reset	<i>Real</i>	-	-	1 = 1
80.40	HQ curve H1	<i>Real</i>	0.00...32767.00	m	100 = 1
80.41	HQ curve H2	<i>Real</i>	0.00...32767.00	m	100 = 1
80.42	HQ curve H3	<i>Real</i>	0.00...32767.00	m	100 = 1
80.43	HQ curve H4	<i>Real</i>	0.00...32767.00	m	100 = 1
80.44	HQ curve H5	<i>Real</i>	0.00...32767.00	m	100 = 1
80.50	PQ curve P1	<i>Real</i>	0.00...32767.00	kW	100 = 1
80.51	PQ curve P2	<i>Real</i>	0.00...32767.00	kW	100 = 1
80.52	PQ curve P3	<i>Real</i>	0.00...32767.00	kW	100 = 1
80.53	PQ curve P4	<i>Real</i>	0.00...32767.00	kW	100 = 1
80.54	PQ curve P5	<i>Real</i>	0.00...32767.00	kW	100 = 1
80.60	Q value Q1	<i>Real</i>	0.00...200000.00	m ³ /h	100 = 1
80.61	Q value Q2	<i>Real</i>	0.00...200000.00	m ³ /h	100 = 1

No.	Name	Type	Range	Unit	FbEq32
80.62	Q value Q3	<i>Real</i>	0.00...200000.00	m ³ /h	100 = 1
80.63	Q value Q4	<i>Real</i>	0.00...200000.00	m ³ /h	100 = 1
80.64	Q value Q5	<i>Real</i>	0.00...200000.00	m ³ /h	100 = 1
81 Sensor settings					
81.01	Actual inlet pressure	<i>Real</i>	0.00...32767.00	bar	100 = 1
81.02	Actual outlet pressure	<i>Real</i>	0.00...32767.00	bar	100 = 1
81.10	Inlet pressure source	<i>Analog src</i>	-	-	1 = 1
81.11	Outlet pressure source	<i>Analog src</i>	-	-	1 = 1
81.12	Sensors height difference	<i>Real</i>	0.00...32767.00	m	100 = 1
81.20	Pressure unit	<i>List</i>	0...3	-	1 = 1
81.21	Flow unit	<i>List</i>	0...2	-	1 = 1
81.22	Length unit	<i>List</i>	69, 72, 73, 27	-	1 = 1
81.23	Density unit	<i>List</i>	0...2	-	1 = 1
82 Pump protections					
82.01	Quick ramp accel. mode	<i>List</i>	0...4	-	1 = 1
82.02	Quick ramp decel. mode	<i>List</i>	0...5	-	1 = 1
82.05	1st quick ramp accel. time	<i>Real</i>	0.10...1800.00	s	1 = 1
82.06	Final quick ramp decel. time	<i>Real</i>	0.10...1800.00	s	1 = 1
82.07	1st quick ramp accel. limit	<i>Real</i>	0...120 Hz / 0...120 rpm	Hz / rpm	1 = 1
82.08	Final quick ramp decel. limit	<i>Real</i>	0...120 Hz / 0...120 rpm	Hz / rpm	1 = 1
82.10	2nd quick ramp accel. time	<i>Real</i>	0.10...1800.00	s	1 = 1
82.11	2nd quick ramp decel. time	<i>Real</i>	0.10...1800.00	s	1 = 1
82.12	2nd quick ramp accel. limit	<i>Real</i>	0...120 Hz / 0...120 rpm	Hz / rpm	1 = 1
82.13	2nd quick ramp decel. limit	<i>Real</i>	0...120 Hz / 0...120 rpm	Hz / rpm	1 = 1
82.14	Oper. quick ramp accel. time (3rd)	<i>Real</i>	0.10...1800.00	s	1 = 1
82.15	Oper. quick ramp decel. time (1st)	<i>Real</i>	0.10...1800.00	s	1 = 1
82.20	Dry run protection	<i>List</i>	0...3	-	1 = 1
82.21	Dry run source	<i>List</i>	0...9	-	1 = 1
82.25	Soft pipe fill supervision	<i>List</i>	0...2	-	1 = 1
82.26	Time-out limit	<i>Real</i>	0.0...1800.0	s	10 = 1
82.30	Outlet minimum pressure protection	<i>List</i>	0...3	-	1 = 1
82.31	Outlet minimum pressure warning level	<i>Real</i>	0.00...32767.00	bar	100 = 1
82.32	Outlet minimum pressure fault level	<i>Real</i>	0.00...32767.00	bar	100 = 1

No.	Name	Type	Range	Unit	FbEq32
82.35	Outlet maximum pressure protection	List	0...3	-	1 = 1
82.37	Outlet maximum pressure warning level	Real	0.00...32767.00	bar	100 = 1
82.38	Outlet maximum pressure fault level	Real	0.00...32767.00	bar	100 = 1
82.40	Inlet minimum pressure protection	List	0...3	-	1 = 1
82.41	Inlet minimum pressure warning level	Real	0.00...32767.00	bar	100 = 1
82.42	Inlet minimum pressure fault level	Real	0.00...32767.00	bar	100 = 1
82.45	Pressure check delay	Real	0.00...3600.00	s	100 = 1
83 Pump cleaning					
83.01	Pump cleaning status	Binary src	-	-	-
83.02	Pump cleaning progress	Real	0.0...100.0	%	1 = 1
83.03	Total cleaning count	Real	0...1000000	-	1 = 1
83.10	Pump cleaning action	Binary src	-	-	-
83.11	Pump cleaning triggers	PB	0000h...FFFFh	-	1 = 1
83.12	Manually force cleaning	Binary src	-	-	-
83.15	Fixed time interval	Time	00:00:00...45:12:15	s	1 = 1
83.16	Cycles in cleaning program	Real	1...65535	-	1 = 1
83.20	Cleaning speed step	Real	0...100	%	1 = 1
83.25	Time to cleaning speed	Real	0.000...60.000	s	1 = 1
83.26	Time to zero-speed	Real	0.000...60.000	s	1 = 1
83.27	Cleaning on time	Real	0.000...1000.000	s	1 = 1
83.28	Cleaning off time	Real	0.000...1000.000	s	1 = 1
83.35	Cleaning count fault	Binary src	-	-	1 = 1
83.36	Cleaning count time	Time	00:00:00...45:23:59	s	1 = 1
83.37	Maximum cleaning count	Real	0...30	-	1 = 1
94 LSU control					
<i>(Parameters 94.01...94.41 only visible for ACQ580-31 and ACQ580-34)</i>					
94.01	LSU control	List	0...1	-	1 = 1
94.02	LSU panel communication	List	0...1	-	1 = 1
94.04	INU-LSU status word profile	List	0...1	-	1 = 1
94.10	LSU max charging time	Real	0...65535	s	1 = 1 s
94.11	LSU stop delay	Real	0.0 ... 3600.0	s	10 = 1 s
94.22	User DC voltage reference	Real	0.0 ... 2000.0	V	10 = 1 V
94.32	User reactive power reference	Real	-3276.8 ... 3276.7	kvar	10 = 1 kvar
94.40	Power mot limit on net loss	Real	0.00 ... 600.00	%	100 = 1%

No.	Name	Type	Range	Unit	FbEq32
94.41	Power gen limit on net loss	<i>Real</i>	-600.00 ... 0.00	%	100 = 1%
95 HW configuration					
95.01	Supply voltage	<i>List</i>	0...3, 5	-	1 = 1
95.02	Adaptive voltage limits	<i>List</i>	0...3, 5	-	1 = 1
95.03	Estimated AC supply voltage	<i>Real</i>	0...65535	V	1 = 1 V
95.04	Control board supply	<i>List</i>	0...1	-	1 = 1
95.15	Special HW settings	<i>PB</i>	00000000h...FFFFFFFh	-	1 = 1
95.20	HW options word 1	<i>PB</i>	0000h...FFFFh	-	1 = 1
95.21	HW options word 2	<i>PB</i>	0000h...FFFFh	-	1 = 1
95.26	Motor disconnect detection	<i>List</i>	0...1	-	1 = 1
95.200	Cooling fan mode	<i>List</i>	0...1	-	1 = 1
96 System					
96.01	Language	<i>List</i>	-	-	1 = 1
96.02	Pass code	<i>Data</i>	0...99999999	-	1 = 1
96.03	Access level status	<i>PB</i>	00000000h...FFFFFFFh	-	1 = 1
96.04	Macro select	<i>List</i>	0...1	-	1 = 1
96.05	Macro active	<i>List</i>	1	-	1 = 1
96.06	Parameter restore	<i>List</i>	0, 2, 8, 32, 62, 512, 1024, 34560	-	1 = 1
96.07	Parameter save manually	<i>List</i>	0...1	-	1 = 1
96.08	Control board boot	<i>List</i>	0...1	-	1 = 1
96.10	User set status	<i>List</i>	0...7, 20...23	-	1 = 1
96.11	User set save/load	<i>List</i>	0...5, 18...21	-	1 = 1
96.12	User set I/O mode in1	<i>Binary src</i>	-	-	-
96.13	User set I/O mode in2	<i>Binary src</i>	-	-	-
96.16	Unit selection	<i>PB</i>	0000h...FFFFh	-	1 = 1
96.20	Time sync primary source	<i>List</i>	0, 3, 6, 8, 9	-	1 = 1
96.51	Clear fault and event logger	<i>Real</i>	0...1	-	1 = 1
96.54	Checksum action	<i>List</i>	0...4	-	1 = 1
96.55	Checksum control word	<i>PB</i>	0000h...FFFFh	-	1 = 1
96.68	Actual checksum A	<i>PB</i>	00000000h...FFFFFFFh	-	1 = 1
96.69	Actual checksum B	<i>PB</i>	00000000h...FFFFFFFh	-	1 = 1
96.70	Disable adaptive program	<i>List</i>	0...1	-	1 = 1
96.71	Approved checksum A	<i>PB</i>	00000000h...FFFFFFFh	-	1 = 1
96.72	Approved checksum B	<i>PB</i>	00000000h...FFFFFFFh	-	1 = 1
96.78	550 Compatibility mode	<i>List</i>	0...2	-	1 = 1
96.78	Legacy Modbus mapping	<i>List</i>	0...1	-	1 = 1
96.79	Legacy control profile	<i>List</i>	0...3	-	1 = 1
96.100	Change user pass code	<i>Data</i>	10000000...99999999	-	1 = 1
96.101	Confirm user pass code	<i>Data</i>	10000000...99999999	-	1 = 1

No.	Name	Type	Range	Unit	FbEq32
96.102	User lock functionality	<i>PB</i>	0000h...FFFFh	-	1 = 1
<i>(Parameter 96.108 only visible for ACQ580-31 and ACQ580-34)</i>					
96.108	LSU control board boot	<i>Real</i>	0...1	-	1 = 1
97 Motor control					
97.01	Switching frequency reference	<i>List</i>	2, 4, 8, 12	kHz	1 = 1 kHz
97.02	Minimum switching frequency	<i>List</i>	1, 2, 4, 8, 12	kHz	1 = 1 kHz
97.03	Slip gain	<i>Real</i>	0...200	%	1 = 1%
97.04	Voltage reserve	<i>Real</i>	-4...50	%	1 = 1%
97.05	Flux braking	<i>List</i>	0...2	-	1 = 1
97.08	Optimizer minimum torque	<i>Real</i>	0.0...1600.0	%	10 = 1%
97.10	Signal injection	<i>List</i>	0...4	-	1 = 1
97.11	TR tuning	<i>Real</i>	25...400	%	1 = 1%
97.13	IR compensation	<i>Real</i>	0.00...50.00	%	100 = 1%
97.15	Motor model temperature adaptation	<i>List</i>	0...1	-	1 = 1
97.16	Stator temperature factor	<i>Real</i>	0...200	%	1 = 1%
97.17	Rotor temperature factor	<i>Real</i>	0...200	%	1 = 1%
97.20	U/F ratio	<i>List</i>	0...1	-	1 = 1
97.48	UDC stabilizer	<i>List</i>	0, 50, 100, 300, 500, 800	-	1 = 1
97.49	Slip gain for scalar	<i>Real</i>	0...200	%	1 = 1%
97.94	IR comp max frequency	<i>Real</i>	1.0...200.0	%	1 = 1%
97.135	UDC ripple	<i>Real</i>	0.0...200.0	V	10 = 1V
98 User motor parameters					
98.01	User motor model mode	<i>List</i>	0...1	-	1 = 1
98.02	Rs user	<i>Real</i>	0.0000...0.50000	p.u.	100000 = 1 p.u.
98.03	Rr user	<i>Real</i>	0.0000...0.50000	p.u.	100000 = 1 p.u.
98.04	Lm user	<i>Real</i>	0.00000...10.00000	p.u.	100000 = 1 p.u.
98.05	SigmaL user	<i>Real</i>	0.00000...1.00000	p.u.	100000 = 1 p.u.
98.06	Ld user	<i>Real</i>	0.00000...10.00000	p.u.	100000 = 1 p.u.
98.07	Lq user	<i>Real</i>	0.00000...10.00000	p.u.	100000 = 1 p.u.
98.08	PM flux user	<i>Real</i>	0.00000...2.00000	p.u.	100000 = 1 p.u.
98.09	Rs user SI	<i>Real</i>	0.00000...100.00000	ohm	100000 = 1 p.u.
98.10	Rr user SI	<i>Real</i>	0.00000...100.00000	ohm	100000 = 1 p.u.
98.11	Lm user SI	<i>Real</i>	0.00...100000.00	mH	100 = 1 mH
98.12	SigmaL user SI	<i>Real</i>	0.00...100000.00	mH	100 = 1 mH

No.	Name	Type	Range	Unit	FbEq32
98.13	Ld user SI	<i>Real</i>	0.00...100000.00	mH	100 = 1 mH
98.14	Lq user SI	<i>Real</i>	0.00...100000.00	mH	100 = 1 mH
99 Motor data					
99.03	Motor type	<i>List</i>	0...2	-	1 = 1
99.04	Motor control mode	<i>List</i>	0...1	-	1 = 1
99.06	Motor nominal current	<i>Real</i>	0.0...6400.0	A	10 = 1 A
99.07	Motor nominal voltage	<i>Real</i>	0.0...960.0	V	10 = 1 V
99.08	Motor nominal frequency	<i>Real</i>	0.00 ... 500.00	Hz	100 = 1 Hz
99.09	Motor nominal speed	<i>Real</i>	0 ... 30000	rpm	1 = 1 rpm
99.10	Motor nominal power	<i>Real</i>	0.00...10000.00 kW or 0.00 ... 13404.83 hp	kW or hp	100 = 1 unit
99.11	Motor nominal cos Φ	<i>Real</i>	0.00 ... 1.00	-	100 = 1
99.12	Motor nominal torque	<i>Real</i>	0.000...4000000.000 N·m or 0.000...2950248.597 lb·ft	N·m or lb·ft	1000 = 1 unit
99.13	ID run requested	<i>List</i>	0...3, 5...6, 8	-	1 = 1
99.14	Last ID run performed	<i>List</i>	0...3, 5...6, 8	-	1 = 1
99.15	Motor polepairs calculated	<i>Real</i>	0...1000	-	1 = 1
99.16	Motor phase order	<i>List</i>	0...1	-	1 = 1

Further information

Product and service inquiries

Address any inquiries about the product to your local ABB representative, quoting the type designation and serial number of the unit in question. A listing of ABB sales, support and service contacts can be found by navigating to www.abb.com/searchchannels.

Product training

For information on ABB product training, navigate to new.abb.com/service/training.

Providing feedback on ABB Drives manuals

Your comments on our manuals are welcome. Navigate to new.abb.com/drives/manuals-feedback-form.

Document library on the Internet

You can find manuals and other product documents in PDF format on the Internet at www.abb.com/drives/documents.



abb.com/drives



3AXD50000035867E