

# MK608BPM Series

## Direct-operated, Pressure Reducing Valves

The MK608BPM series are spring loaded, self actuated, direct-operated, valves. Pressure relief valves are used to protect the system from overpressure.

They are available in 1 up to 10 inches (DN25 through DN250) body sizes. These regulators feature a construction capable of sustaining rugged use and their construction makes them easy to install and to maintain.

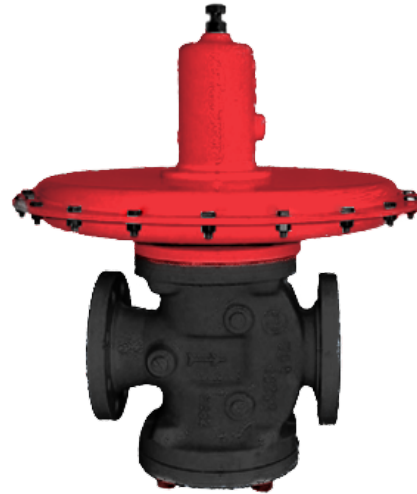

### FEATURES

- Available with ISA Face to face dimensions
- 3 different trim size for each body size, to meet a wide range of applications
- Quick-opening flow characteristic
- Trim features Metal or Soft tightness, single or double ported
- Leakage Classes range from II up to VI (according to ANSI/FCI 70-3)
- Internal pressure sensing
- Wide range of actuators according to the requested regulation range
- Wide range of elastomeric diaphragms.
- Exotic materials available (duplex, super duplex, monel, etc.)
- Variety of end connections available

## SPECIFICATIONS

**Function:** Reducing/ Relief/ Backpressure

**Line Sizes:** 1" up to 10" (DN25 - DN250) (ISA Standard), up to 20" (special)

**End Connections:** Flanged (ANSI or NP)

**Seat:** Single/ Double

**Max Rating:** ANSI 1500

**CV:** From 6 up to 850 (standard)

**Body Material:**

- Carbon Steel
- Stainless Steel
- "Exotic" Materials

**Trim Material:**

- Stainless Steel (std)
- "Exotic" Materials

**Diaphragms:**

- Polychloroprene
- EPDM
- FKM
- other

**Max Inlet Pressure:** 3,626 psig (250 barg (rating class 1500))

**Regulated Pressure Range:** 0.017 - 445.27 psig (0,0012 - 30,7 barg)

**Min/ Max Temperature:** 122°F/ 392°F (-50°C/ 200°C)

**SPECIFICATIONS, CONT.**

**Table 1 - Fluid Applications**

Gas	Air, inert gas, CO <sub>2</sub> , CO, hydrocarbons, O <sub>2</sub> , H <sub>2</sub> , F, NH <sub>3</sub> .
Steam/Vapour	Water Steam, alcoholic vapours, organic vapours, sulphuric acid, refrigerating vapor
Liquid	Water, aqueous solutions, hydrocarbons, alcohol, lubricating oils, diathermic, oils, solvents, refrigerating fluids, acrylic compounds

**Table 2- CV (Kv) Values | Double seated valves**

Trim Size	Seat diameter (mm)	DN							
		25	40	50	80	100	150	200	250
1/2"	16,5/14,5	6 (5,2)							
3/4"	20,5/18,5	9 (7,8)	9 (7,8)						
1"	25/23	13 (11,2)	18 (15,6)	18 (15,6)					
1 1/2"	40/38		40 (34,6)	43 (37,2)	43 (37,2)	64 (55,4)			
2"	50/48			54 (46,7)	64 (55,4)	128 (110,7)	128 (110,7)		
3"	70/68				112 (96,9)	204 (176,5)	240 (176,5)	240 (176,5)	
4"	90/88						430 (372)	440 (380,6)	
6"	135/132							620 (536,3)	440 (380,6)
8"	180/177								720 (622,8)
10"	225/222								850 (735,3)

**Table 3- Actuator Spring Ranges**

Actuator	Minimum		Maximum		Maximum allowable pressure	
120	58.0 psig	(4,00 barg)	390 psig	(26,9 barg)	445 psig	(31 barg)
140	29.0 psig	(2,00 barg)	222 psig	(15,3 barg)	249 psig	(17 barg)
182	13.1 psig	(0,90 barg)	99psig	(6,8 barg)	112 psig	(7,7 barg)
245	5.51 psig	(0,380 barg)	42.1 psig	(2,9 barg)	47.0 psig	(3,2 barg)
345	0.07 psig	(0,0045 barg)	17.4 psig	(1,2 barg)	19.4 psig	(1,3 barg)
515	0.02 psig	(0,0015 barg)	7.0 psig	(0,48 barg)	7.3 psig	(0,5 barg)

\*Value achieved with resilient (elastomeric) seat leakage. For tank blanketing application.

**NOTE:**

Actuators spring ranges are based on the following assumptions:

- Stroke from setpoint is ±7mm
- Offset max 33% for minimum set pressure
- Low unbalancing forces on the plug
- Metal tightness, unless otherwise specified

If different operating conditions are required, please contact Richards Industries.

**SPECIFICATIONS, CONT.**

**Table 4 - Material Combination**

<b>Body</b>			
	<b>Carbon steel (AF2)</b>	<b>316 SS (IF2)</b>	<b>Full 316 SS (IF3)</b>
	-29°C ≤ T ≤ 427°C	-29°C ≤ T ≤ 540°C	-196°C ≤ T ≤ 540°C
	(-20°F ≤ T ≤ 800°F)	(-20°F ≤ T ≤ 1000°F)	(-321°F ≤ T ≤ 1000°F)
<b>Body</b>	ASME SA-216 WCC	ASME SA-351 CF8M	ASME SA-351 CF8M
<b>Bonnet</b>	ASME SA-216 WCC	ASME SA-351 CF8M	ASME SA-351 CF8M
<b>Inferior Cover</b>	ASME SA-216 WCC	ASME SA-351 CF8M	ASME SA-351 CF8M
<b>Packing</b>	See Table 5		
<b>Gaskets set</b>	See Table 6		
<b>Trim</b>			
<b>Seat</b>	ASME A-479 316	ASME A-479 316	ASTM A-479 316
<b>Plug</b>	ASME A-479 316	ASME A-479 316	ASTM A-479 316
<b>Plug Seating Surface</b>	See Table 7		
<b>Guide</b>	ASTM A-564 17-4PH	ASTM A.276/A-479 UNS S21800	ASTM A.276/A-479 UNS S21800
<b>Actuator</b>			
<b>Actuator Cover</b>	ASME SA-216 WCC	ASME SA-351 CF8M	ASME SA-351 CF8M
<b>Yoke</b>	ASME SA-216 WCC	ASME SA-216 WCC	ASME SA-351 CF8M
<b>Spring</b>	ASTM A-401	ASTM A-401	ASTM A-313 316
<b>Diaphragm</b>	See Table 8		

**Note:**

- SS = Stainless Steel
- Carbon steel parts are painted according to Richards Industries internal procedures
- NACE material requirements: these material combinations meet the requirements of NACE MR 0103, non exposed conditions (par. 5.3). In case of exposed conditions (par. 5.2), or a different standard (e.g. NACE MR 0175-2003) please contact factory.

**SPECIFICATIONS, CONT.**

**Table 5 - Temperature range for packing materials**

Materials	Temperature Limits
<b>FKM Lip Seal</b>	-14 to 392°F (-10 to 200°C)
<b>Graphite</b>	-328 to 1110°F (-200 to 600°C)
<b>PTFE coated aramidic fiber</b>	-328 to 500°F (-200 to 260°C)

**Table 6 - Temperature range for flat gaskets**

Materials	Temperature Limits
<b>Polytetrafluoroethylene (PTFE)</b>	-328 to 482°F (-200 to 250°C)
<b>No asbestos</b>	-58 to 392°F (-50 to 200°C)
<b>Graphite + AISI 316</b>	-328 to 1110°F (-200 to 600°C)

**Table 7 - Temperature range for plug seating surface**

Materials	Temperature Limits	Valve Model
<b>Stainless steel</b>	-321 to 1000°F (-196 to 540°C)	MM71 MM72 MM81 MM82
<b>Stellite 6</b>	-238 to 1110°F (-150 to 600°C)	
<b>Fluoroelastomer (FKM-FPM)</b>	-14 to 392°F (-10 to 200°C)	MM73 MM74 MM83 MM84
<b>Chloroprene (CR)</b>	-4 to 194°F (-20 to 90°C)	
<b>Nitrile (NBR)</b>	-13 to 194°F (-25 to 90°C)	
<b>Ethylene-Propylene (EPDM)</b>	-31 to 320°F (-35 to 150°C)	
<b>Silicone (VMQ)</b>	-58 to 300°F (-50 to 150°C)	
<b>Polytetrafluoroethylene (PTFE)</b>	-328 to 482°F (-200 to 250°C)	MM83 MM84

**Table 8 - Temperature range for diaphragms**

Materials	Temperature Limits
<b>Chloroprene (CR)</b>	-4 to 194°F (-20 to 90°C)
<b>NBR</b>	-13 to 194°F (-25 to 90°C)
<b>Fluorocarbon (FKM-FPM) + polyester</b>	14 to 302°F (-10 to 150°C)
<b>Fluorocarbon (FKM-FPM) + polyamid</b>	14 to 392°F (-10 to 200°C)
<b>Ethylene-Propylene (EPDM)</b>	-31 to 320°F (-35 to 150°C)
<b>Fluorosilicone (FVMQ)</b>	-58 to 300°F (-50 to 150°C)

**Note:** Diaphragm material is selected in order to withstand both temperature and chemical composition of the medium.

**SPECIFICATIONS, CONT.**

**Table 9- Body Weights**

Valve Model	Size	ANSI 150		ANSI 300		ANSI 600		ANSI 900		ANSI 1500	
		PN 10-16		PN 25-30				PN160		PN 250	
		lbs	kg	lbs	kg	lbs	kg	lbs	kg	lbs	kg
MM81-MM83 MM82-MM84 (single seated)	1" (DN25)	31	14	33	15	34	16	73	33	73	33
	1 1/2" (DN40)	51	23	56	26	58	27	101	46	101	46
	2" (DN50)	64	29	68	31	73	33	143	65	143	65
	3" (DN80)	123	56	132	60	139	63	196	89	253	115
	4" (DN100)	163	74	172	78	211	96	319	145	387	176
MM71-MM73 MM72-MM74 (double seated)	1" (DN25)	32	15	34	16	35	16	74	34	74	34
	1 1/2" (DN40)	59	27	65	30	67	31	110	50	110	50
	2" (DN50)	79	36	84	38	88	40	154	70	154	70
	3" (DN80)	145	66	154	70	161	73	233	106	295	134
	4" (DN100)	218	99	227	103	255	116	383	174	455	207
	6" (DN150)	370	168	400	182	493	224	//	//	//	//
	8" (DN200)	627	285	667	303	926	421	//	//	//	//
	10" (DN250)	946	430	1005	457	1476	671	//	//	//	//

**Table 10 - Actuator Weights**

Actuator	lbs	kg
120	70	32
140	70	32
182	66	30
245	77	35
345	106	48
515	73	33

**MK608BPM FLANGED VALVE DIMENSIONAL DRAWING**

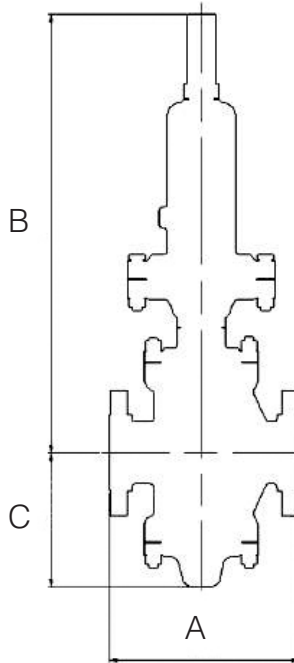

**Table 11- Body Sizes and face-to-face dimensions- Double Seated Valves**

Size	A								
	ANSI B16.5 - RF					UNI - EN1092-1			
	150	300	600	900	1500	PN10-16	PN25-40	PN160	PN250
<b>1" (DN25)</b>	184	197	210	273		197		273	
<b>1 1/2" (DN40)</b>	222	235	251	311		235		311	
<b>2" (DN50)</b>	254	267	286	340		267		340	
<b>3" (DN80)</b>	298	318	337	387	406	318		387	406
<b>4" (DN100)</b>	352	368	394	464	483	352	368	464	483
<b>6" (DN150)</b>	451	473	508	//	//	451	473	//	//
<b>8" (DN200)</b>	543	568	610	//	//	543	568	//	//
<b>10" (DN250)</b>	673	708	752	//	//	673	708	//	//

Size	B		C		
	ANSI 150-600	ANSI 900-1500	ANSI 150-600	ANSI 900	ANSI1500
	PN 10-40	PN160-250	PN 10-40	PN160	PN250
<b>1" (DN25)</b>	717		102	120	
<b>1 1/2" (DN40)</b>	737		125	145	
<b>2" (DN50)</b>	745		146	160	
<b>3" (DN80)</b>	780	810	194	195	215
<b>4" (DN100)</b>	805	835	207	220	235
<b>6" (DN150)</b>	825	//	317	//	//
<b>8" (DN200)</b>	945	//	407	//	//
<b>10" (DN250)</b>	995	//	460	//	//

**MK608BPM FLANGED VALVE DIMENSIONAL DRAWING**

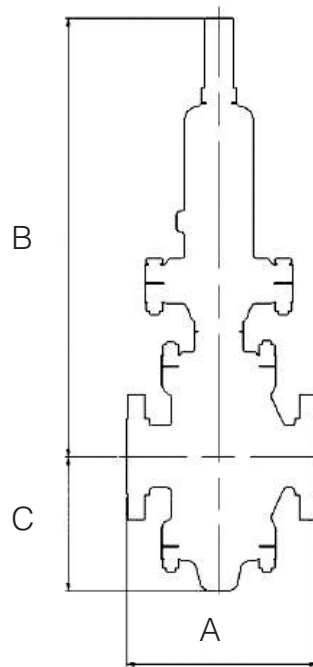

**Table 12- Body Sizes and face-to-face dimensions- Single Seated Valves**

Size	A								
	ANSI B16.5 - RF					UNI - EN1092-1			
	150	300	600	900	1500	PN10-16	PN25-40	PN160	PN250
<b>1" (DN25)</b>	184	197	210	273		197		273	
<b>1 1/2" (DN40)</b>	222	235	251	311		235		311	
<b>2" (DN50)</b>	254	267	286	340		267		340	
<b>3" (DN80)</b>	298	318	337	387	406	318		387	406
<b>4" (DN100)</b>	352	368	394	464	483	352	368	464	483

Size	B		C		
	ANSI 150-600	ANSI 900-1500	ANSI 150-600	ANSI 900	ANSI1500
	PN 10-40	PN160-250	PN 10-40	PN160	PN250
<b>1" (DN25)</b>	652		102	120	
<b>1 1/2" (DN40)</b>	672		125	145	
<b>2" (DN50)</b>	680		146	160	
<b>3" (DN80)</b>	715	745	194	195	215
<b>4" (DN100)</b>	740	770	207	220	235



## MK608BPM ACTUATORS

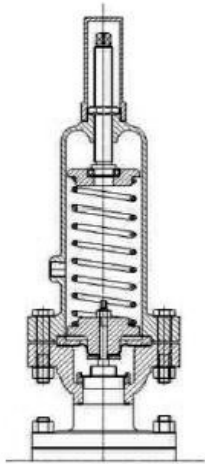

Actuator 120

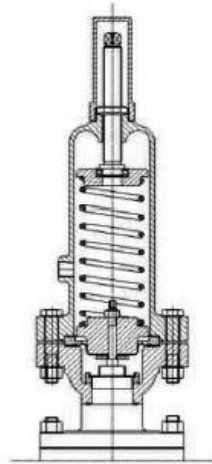

Actuator 140

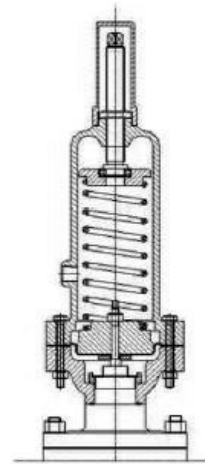

Actuator 182

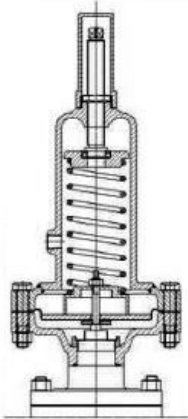

Actuator 245

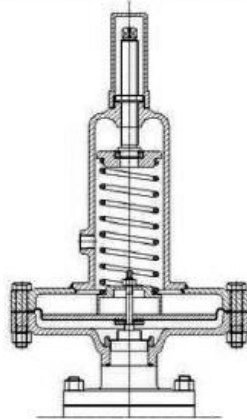

Actuator 345

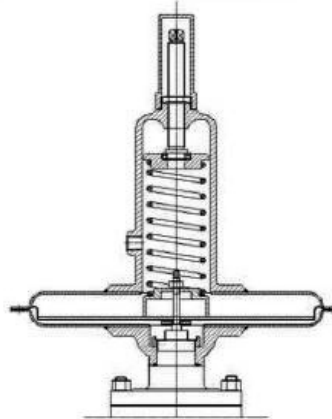

Actuator 515

The drawings to the left show all our available actuators, which are perfectly interchangeable according to the desired pressure regulation (please refer to Table 3). The table below shows the actuators dimensions.

**Table 13- Actuator dimensions**

Actuator	Outer Diameter		Surface	
	inches	mm	in <sup>2</sup>	cm <sup>2</sup>
120	6.9	175	3.22	20,8
140	6.9	175	6.57	42,4
182	7.3	182	14.7	95
245	9.6	245	35.0	226
345	13.6	345	84.5	545
515	20.3	515	209.3	1350



**Jordan Valve, a division of Richards Industries**  
 3170 Wasson Road • Cincinnati, OH 45209  
 513.533.5600 • 800.543.7311 • 513.871.0105 (f)  
 info@richardsind.com • www.jordanttvalve.com

Jordan Valve reserves the right to make revisions to its product, specifications, literature and related information without notice. Please visit our website at [www.jordanvalve.com](http://www.jordanvalve.com) for the latest information on our products.