

Industrial
Automation

Interface
Modules
IM Series

*interface
modul*

APPLICATION GUIDE



Interface Modules

TURCK's IM series of Isolating Intrinsically Safe Barriers is designed to be a simple and safe way to solve the problems associated with the installation of equipment that is used in potentially explosive atmospheres.

TURCK's IM series utilizes the intrinsically safe concept that is universally accepted, easy to apply and the safest way to install electronic measuring, monitoring and control equipment in potentially explosive atmospheres. The IM series uses state of the art circuitry and the latest technology to produce an unsurpassed product that provides the best explosion protection interfaces on the market.

The IM series of Intrinsically Safe Interface Devices is application specific: Each device is designed to work in a specific application, be it analog input, analog output, discrete input, discrete output or others. The series was designed to handle the vast majority of applications where instrumentation and control in potentially explosive atmospheres is typically installed. A small number of interface devices will cover a large number of applications. This is a huge benefit, as limiting the number of different types of interfaces can significantly reduce the number of spares. Reducing the number of model variations of those spares makes replacement or expansion much easier, while also consolidating stock and making inventory easier to manage.

Intrinsic safety has come of age with the introduction of the IM series of Intrinsically Safe Isolating Barriers, making IS applications in potentially explosive atmospheres safe, simple and economically attractive.

Choosing an appropriate IM series Isolator is made simple with the help of this guide. The interface devices outlined within this guide allow you to make the appropriate selection for the corresponding field devices or connections with ease.



IM Series Cabinet

IM Introduction	1
Generic Specifications for IM Series	3
Selection Guide	4
Isolation Switch Relays, IM1	5
Analog Data Transmitters, IM31	31
Analog Input Repeaters/Supplies, IM33.	45
Temperature Converters, IM34	53
Analog Output Isolators, IM35	71
Solenoid Driver/Discrete Output Isolators, IM72.	77
Approvals	85
Control Drawings	86

Generic Specifications for IM Series

Housing. 18 mm, Single or Multi-Channel, 12-Pin Connector Connector Configuration
 27 mm, Multi-Channel, 20-Pin Connector Connector Configuration

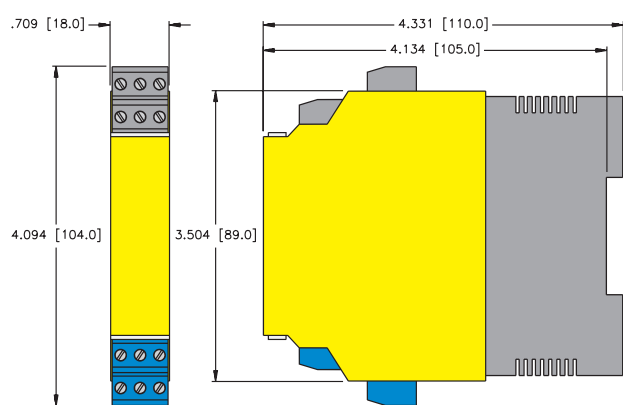

18 mm Housing Size

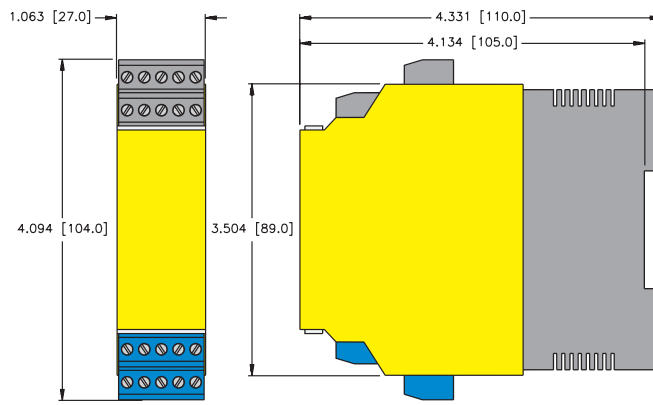

27 mm Housing Size

Material. Polycarbonate/ABS Flammability Class V-0 UL94

Protection Level. IP 20

Operating Temperature . . . -25 to +60°C (-13 to +140°F)

Storage Temperature -40 to +80°C (-40 to +176°F)

Mounting 35 mm Top Hat Rail

Units are Class I, Division 2 groups A, B, C or D hazardous area mountable in an appropriate enclosure.

Units may be mounted side by side without spacing requirements.

Selection Guide

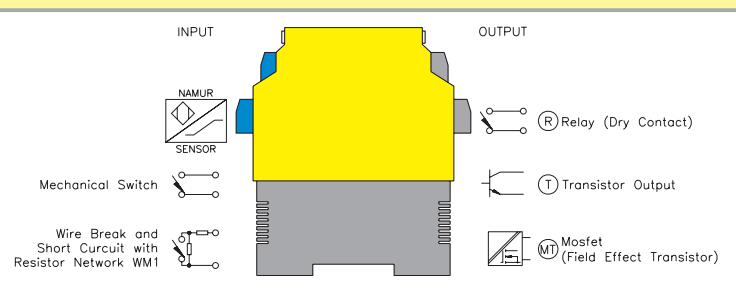
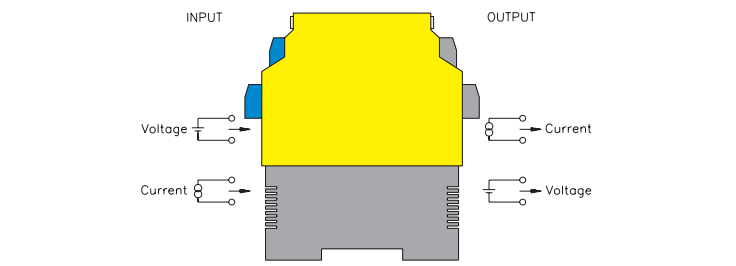
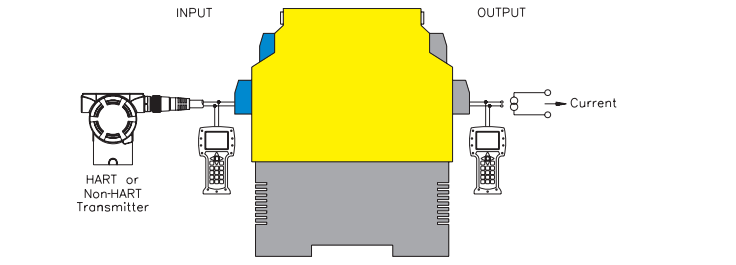
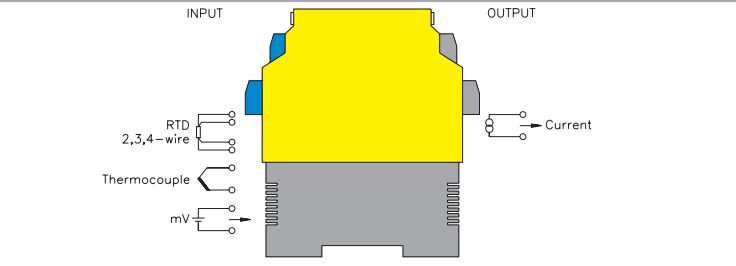
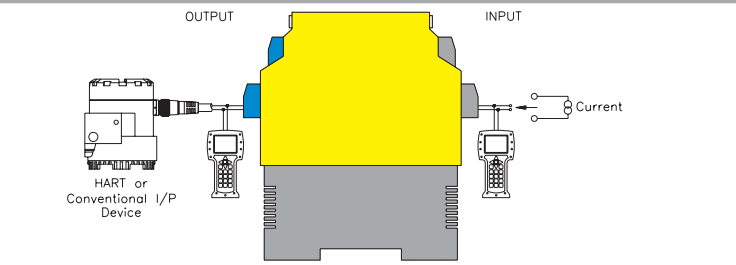
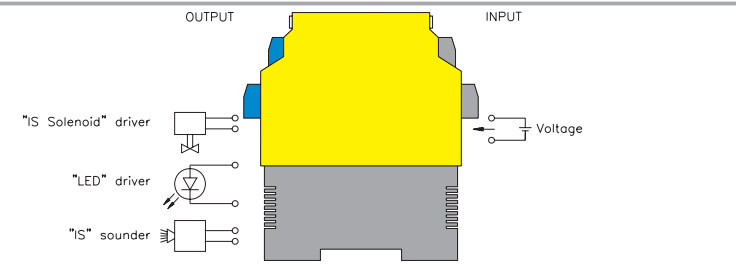
Function	IM Series	Part Number	Pages
	Isolation Switch Relays	IM1-121Ex-R IM1-121-Ex-T IM1-22Ex-R IM1-22Ex-T IM1-22Ex-MT IM1-12Ex-R IM1-12Ex-T IM1-12Ex-MT IM1-451Ex-R IM1-451Ex-T	5 - 30
	Analog Data Transmitters	IM31-11Ex-i IM31-11Ex-U IM31-12Ex-i IM31-22Ex-i IM31-22Ex-U	31 - 43
	Analog Input Repeater/Supplies	IM33-11Ex-Hi/24 VDC IM33-12Ex-Hi/24 VDC IM33-22Ex-Hi/24 VDC	45 - 52
	Temperature Converters	IM34-11Ex-i IM34-12Ex-Ri IM34-11Ex-Ci IM34-12Ex-CRi	53 - 70
	Analog Output Isolators	IM35-11Ex-Hi/24 VDC IM35-22Ex-Hi/24 VDC	71 - 76
	Solenoid Driver/Discrete Output Isolators	IM72-11Ex/L IM72-22Ex/L	77 - 83

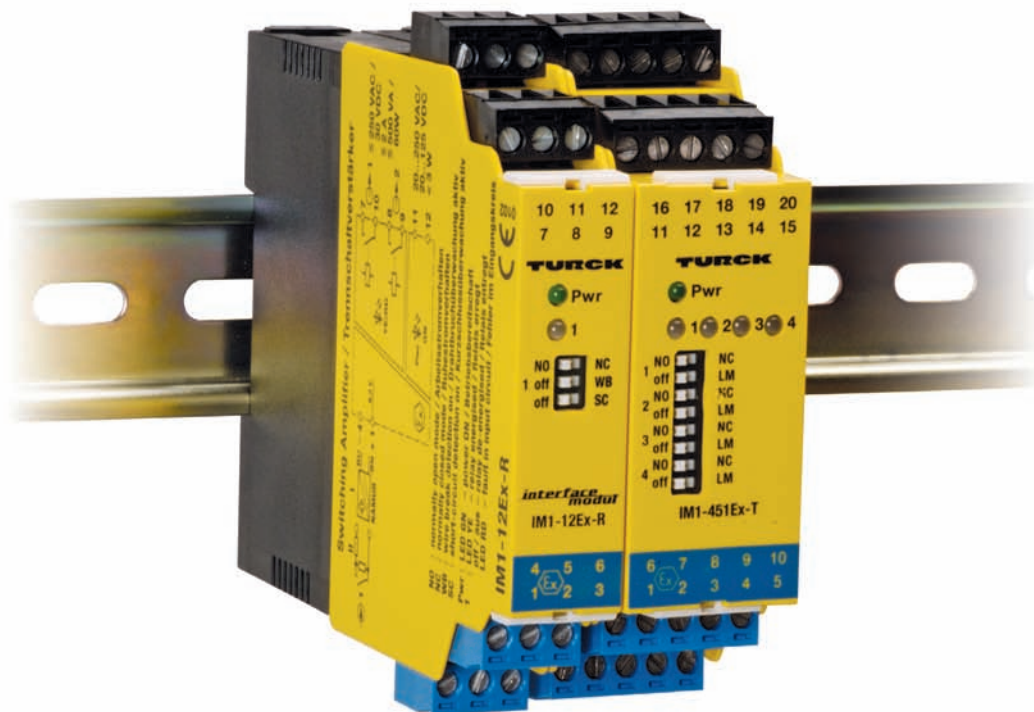

Isolation Switch Relays

For Use with NAMUR Proximity Sensors and Mechanical Switches

TURCK offers a wide range of isolating switch relays. These devices can serve various applications ranging from a single dry contact switch input with a complimentary dry contact switch output, to four NAMUR proximity inputs and four transistor outputs, while also providing open and short-circuit protection in addition to alarm functionality.

Isolation switch relays may be used in general purpose applications, and most are certified for use in hazardous (explosive atmospheres) areas by various approvals bodies. These devices carry U.S., Canadian and European approvals that may be required in order to cover projects being engineered for use in locations throughout the world. The devices share many common attributes, such as housings and removable terminal connectors. Most are also available with the universal voltage (20-250 VAC/20-125 VDC) required to power the unit. All units have the option for short-circuit and open-circuit (wire-break) protection: a simple series of switches that can be manually configured by the user if the function is to be implemented. A resistor network (WM1 shown in Figure 1) is required to incorporate these functions when using a mechanical (dry contact) switch for the hazardous area inputs.

The IM series of isolation switch relays is designed to handle the vast majority of applications where mechanical switches or NAMUR proximity sensors are used. Short-circuit and open-circuit (wire-break) functions are available for most devices. This function can be implemented by appropriately configuring the switches located on the top of the units. NAMUR proximity switches have no special requirements in order to incorporate this function, simply set the switches to the appropriate positions.

Dry contact (mechanical switches) however, require the use of a resistor network in order for the additional functions to operate properly. The incorporation of a ready made resistor network module (WM1 see Figure 1) is recommended.

This section highlights the devices and provides a simple approach for installing the various models available. Examples of common applications are provided along with simple connection diagrams that allow any user to easily and safely install these devices.

Typical and specific functions for each individual device are highlighted in the "Features" portion of the specification pages. A handy pin-out reference chart is also provided for each device. Input and output common configurations for use with NAMUR proximity sensors and dry contact mechanical switches, are also highlighted in this section.

Common Input Configuration for Proximity Sensors

NAMUR 2-wire proximity sensors are specifically designed to work with **TURCK** isolation switch relays. No entity calculations are required, as all NAMUR proximity sensors and associated apparatus with NAMUR inputs (**TURCK** isolation switch relays) are designed to be 100% compatible without the requirement to calculate entity parameters. These calculations are accounted for in the design of both the field devices (proximity sensors) and the interfaces (barriers). All NAMUR proximity sensors are compatible with NAMUR interface devices in all classified areas.

The 2-wire configuration is standardized so the blue wire is always negative and the brown wire is always positive. Reversing these connections will not damage the device, however it will not function.

Connection diagrams for individual devices are shown in the product specification description pages.

Common Input Configurations for Dry Contact Mechanical Switches

Simple switch inputs are easily accommodated by the NAMUR input interface units. Switches are not required to be approved as intrinsically safe devices. Simple switches are defined as "simple apparatus" by the national electrical code as: (NEC 504-2)

A device that will neither generate nor store more than 1.2 V, 0.1 A, 25 mW, or 20 μ .

Using a simple switch does require the use of a resistor network (WM1) if the short-circuit and open-circuit (wire-break) functions are not used. These functions are not required and can be disabled by simply switching the function "OFF" using the configuration switches on the top of the units.

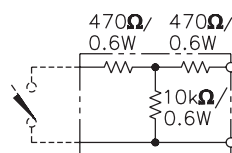
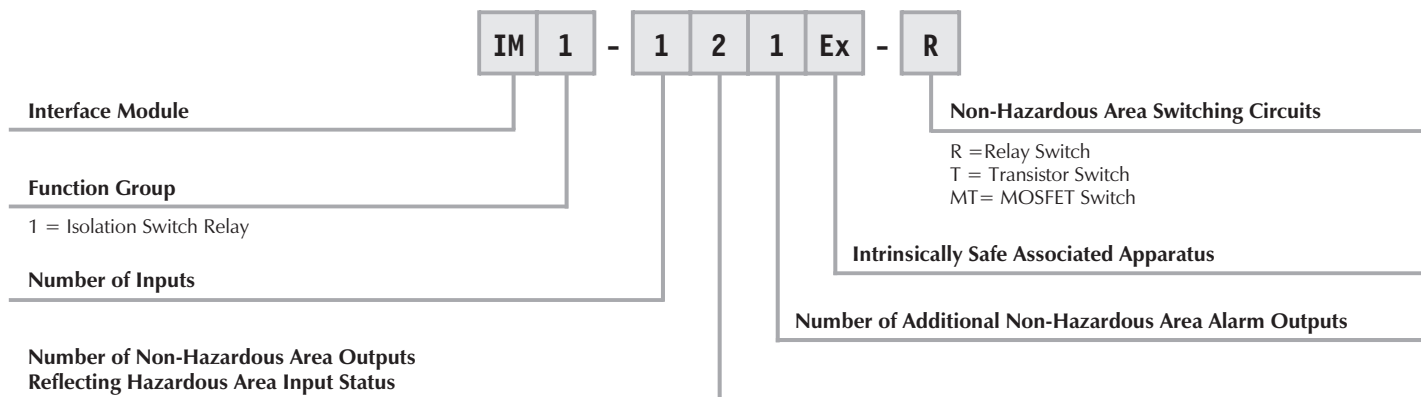

Figure 1

Isolation Switch Relays

Part Number Key

Part number keys are to assist in IDENTIFICATION ONLY. Consult factory for catalog items not identified.



Extension Examples:

IM1-121Ex-R

Isolation Switch Relay
Interface Module
Single Input
Two Non-Hazardous Area Relay Switches
One Non-Hazardous Area Alarm Switch
Intrinsically Safe Associated Apparatus
Relay Switch

IM1-22Ex-MT

Isolation Switch Relay
Interface Module
Two Inputs
Two Non-Hazardous Area Relay Switches
Intrinsically Safe Associated Apparatus
MOSFET Switch

IM1-451Ex-T

Isolation Switch Relay
Interface Module
Four Inputs
Five Non-Hazardous Area Relay Switches
One Non-Hazardous Area Alarm Switch
Intrinsically Safe Associated Apparatus
Transistor Switch

All IM1-xxx Modules are Equipped With:

Intrinsically Safe Field Terminals

This feature allows the use of any certified NAMUR sensor or dry contact mechanical switch (simple apparatus) to be used in any area classification without risk of explosion.

Universal Input Voltage

This feature allows any power supply with an output of 20-250 VAC or 20-125 VDC to be used to power the units. This provides extreme flexibility in the source power required to operate the units.

Removable "Keyed" Terminals

This feature allows easy wiring. The keyed connectors assure safe and accurate installation. Terminals can be removed and wired without physically making the connections in tight quarters. Cable harnesses that incorporate these connectors can actually be wired outside cabinets, and assembly is completed by plugging in the terminals to the corresponding barrier. A bus power configuration is also available. That allows several barrier's power connections to be bussed in a daisy-chain configuration, further reducing installation time and wiring. Replacement of units when necessary is also simplified.

Short-circuit and Open-circuit Detection

This feature allows monitoring of field circuits for wire faults. The function is selectable and can be disabled if not required or desired. NAMUR sensors need no accessory to provide the function. Dry contact mechanical switches require a resistor network to properly function. The WM1 resistor network module will provide this function, or a network of discrete resistors can be added by the user. Utilization of a common non-hazardous area alarm circuit signifies a fault in the hazardous area wiring.

N.O./N.C. Configuration

This feature allows the input function to be selected as a normally open or normally closed output. Each channel can be separately configured depending on module type.

Galvanic Isolation

This feature provides isolation between inputs, outputs and the power supply. In some cases, individual outputs are also isolated from each other.

Switching Status and Power Indication LEDs

This feature provides a visual indication for the switching status of each channel. The green LED indicates that the unit is powered. The dual color LEDs indicate switching (yellow) and fault status (red). A fault status on an input disables the corresponding output relay.

Housing Sizes

The size depends on the number of channels. All 4-channel devices utilize the wider 27 mm housing, while the 1 and 2-channel devices are housed in the 18 mm style. Both are the same height, and can be mounted on a DIN-rail or flush mounted on a panel.

Hazardous (Classified) Area

The hazardous area terminals of the IM series switch input isolators are suitable for use with mechanical switch or NAMUR inputs in ALL area classifications.

Shown here is the common input configuration for a NAMUR proximity sensor. The wires are color coded and blue is always the (-) terminal and brown is always the (+) terminal.

Open-circuit (wire-break) and short-circuit can be configured by the switch settings on the top of the unit, if the unit is equipped with this function. No special conditions are required to incorporate the function when using NAMUR proximity sensors.

Division/Zone 2 or Non-Hazardous Areas

IM units are certified to be mounted in a Division/Zone 2 area. Units must be housed in an appropriate enclosure suitable for the environment in which they will be installed.

Explosion-proof or purged enclosures are not required for use in this area classification with the **TURCK** IM series.

Non-Hazardous (Non-classified) Area

Non-hazardous area terminals are designed to be connected to apparatus in a non-classified area. The equipment may consist of alarm circuits, PLC or DCS controllers or other similar types of equipment.

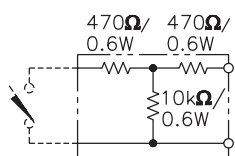

WM1 Configuration

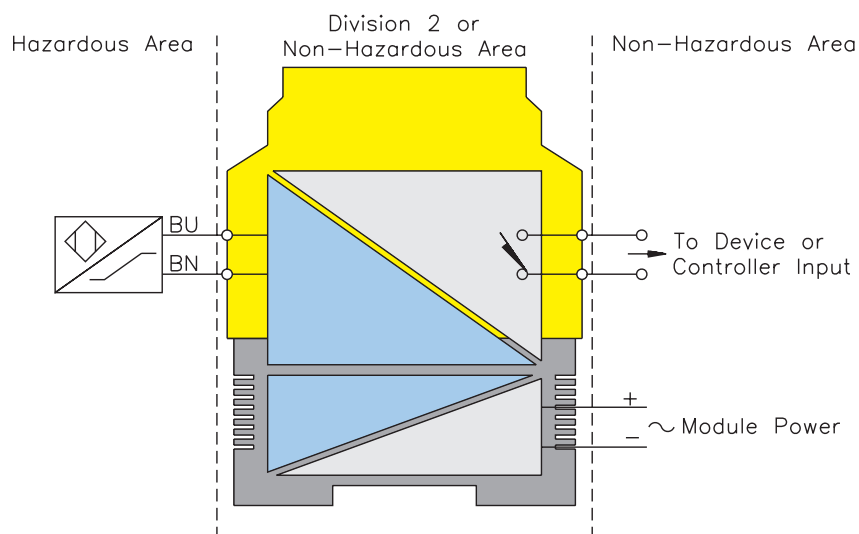

Interface Module Application Guide

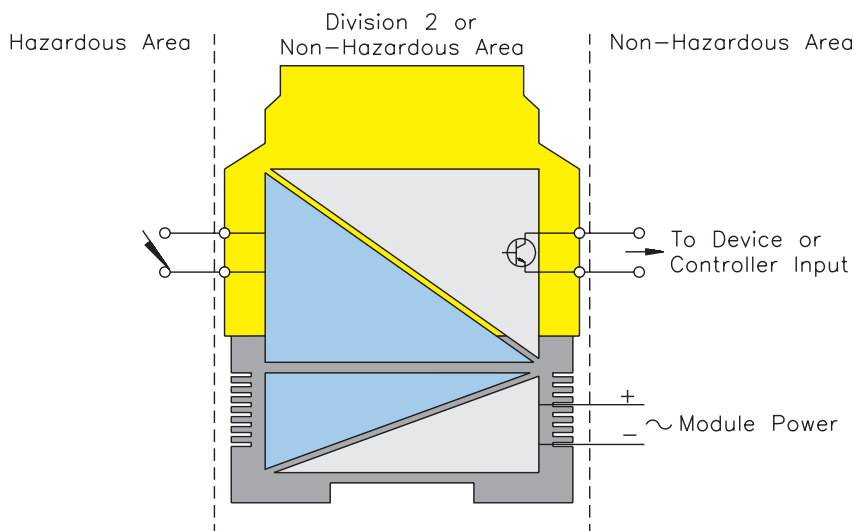
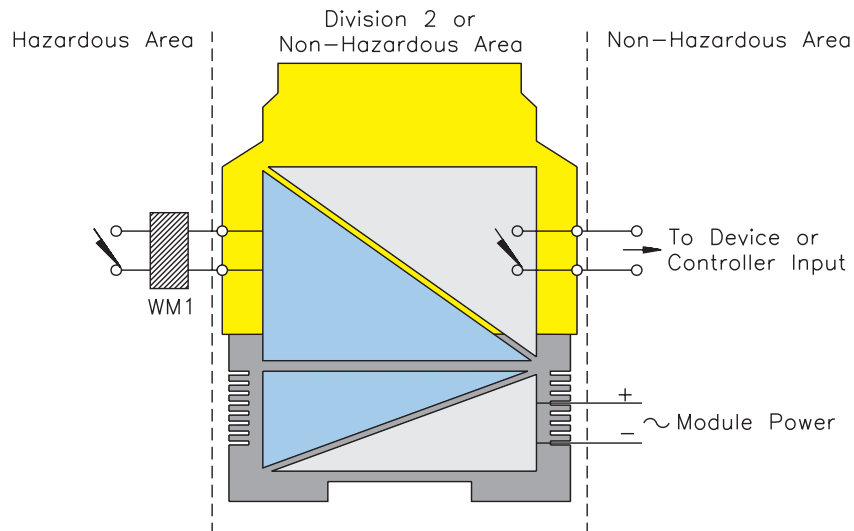
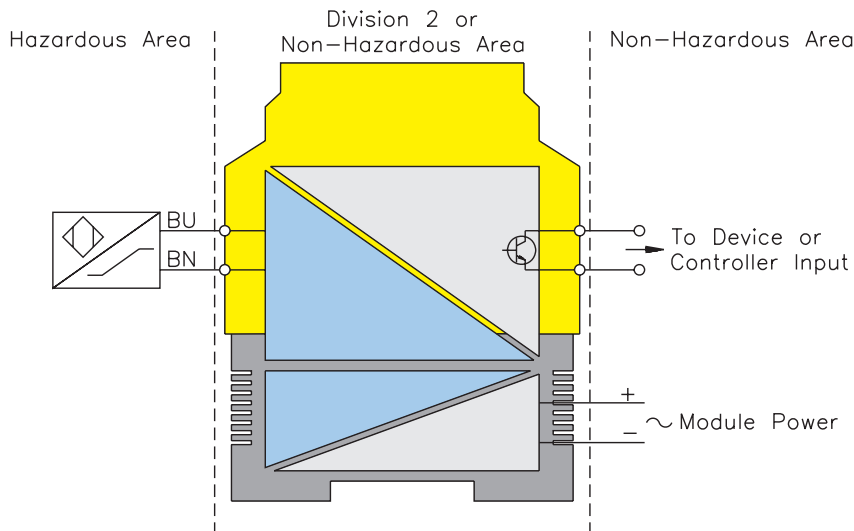

IM1-121Ex-R

Isolation Switch Relays

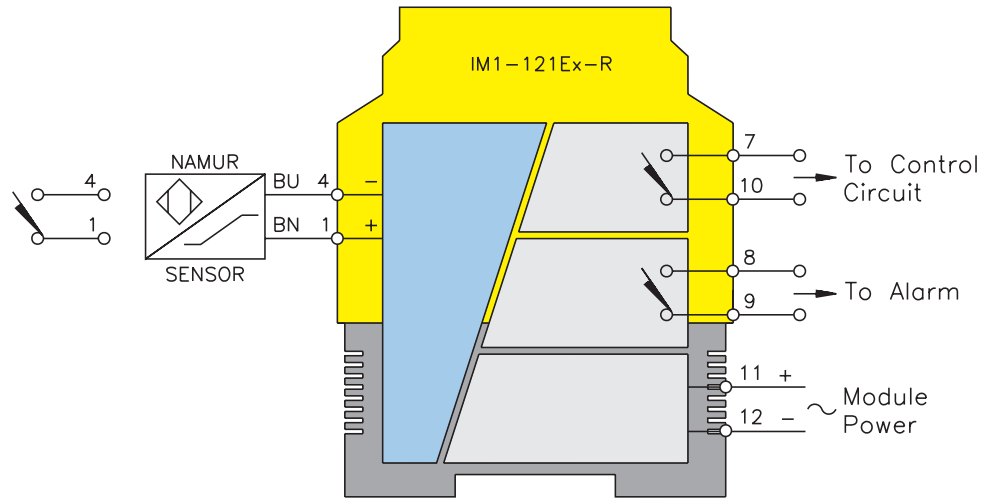

Functional Description:

This 1 channel intrinsically safe interface device is designed to accommodate 1 switch or NAMUR proximity sensor input from a hazardous area and repeat the change of state of the field circuits to a control system located in a non-hazardous area.

The non-hazardous area output is a SPST switch reflecting the corresponding input change of state from the field circuit.

The device also incorporates a separate SPST Non-Hazardous area alarm switch for monitoring open or short-circuits in the hazardous area.

Features:

- 1 channel input for NAMUR sensors or mechanical switches
- Monitoring of field wiring for open or short-circuit (if required)
- Configuration switches on top of unit for easy access
- 2 non-hazardous area switch outputs, 1 for alarm function
- Selectable N.O./N.C. outputs

Electrical Parameters:

Inputs: Hazardous Area

Supply Voltage - (20-250 VAC or 20-125 VDC)
 Inputs (8.2 V, 8.2 mA)
 Switching Threshold 1.55 mA
 Hysteresis Typical 0.2 mA
 Open-circuit Threshold ≤0.1 mA
 Short-circuit Threshold ≥6.0 mA

Outputs: Non-Hazardous Area

2 Relays, 1 N.O. Contact Each
 Voltage ≥250 VAC/120 VDC
 Current ≥2 A per channel
 Capacity ≥500 VA/60 W per channel
 Switch Frequency ≥10 Hz
 Contacts Silver-Alloy + Au (3 micro μ)

For entity parameters see control drawings on pages 86-91.

Isolation Switch Relays

IM1-121Ex-R

Pin #	Terminal Function
1	(+) to Field Device
2	No Connection
3	No Connection
4	(-) to Field Device
5	No Connection
6	No Connection
7	Non-Hazardous Area Switch #1
8	Non-Hazardous Area Switch #2 Alarm
9	Non-Hazardous Area Switch #2 Alarm
10	Non-Hazardous Area Switch #1
11	Module Power (+) or AC
12	Module Power (-) or AC

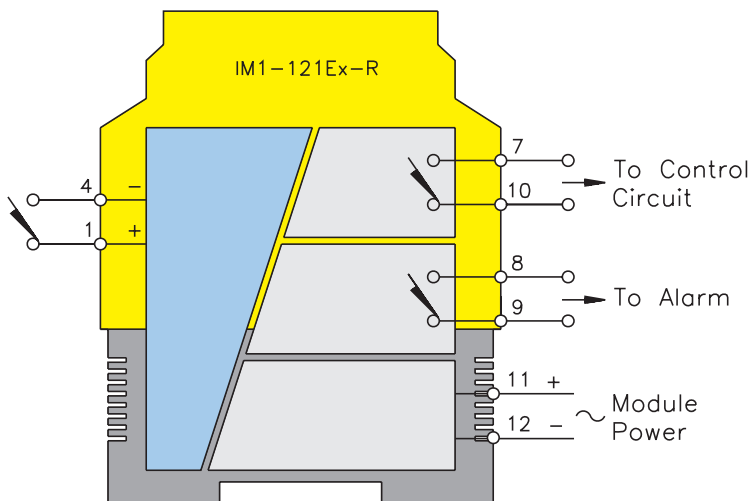
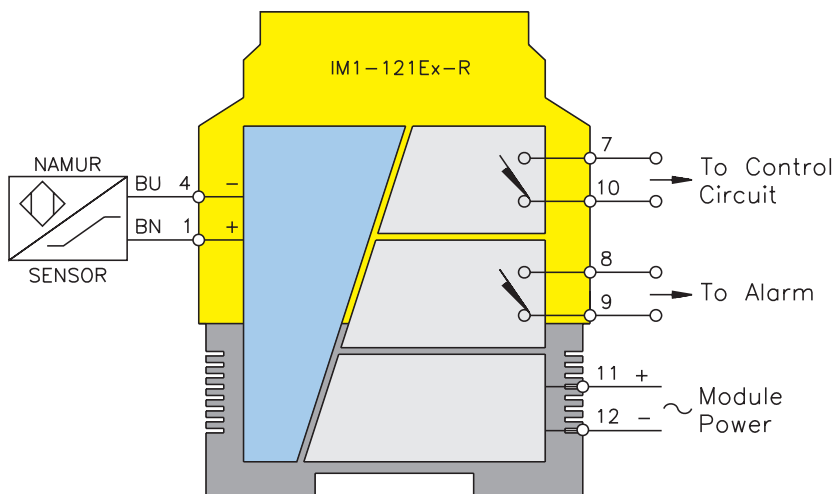

IM1-121Ex-T

Isolation Switch Relays

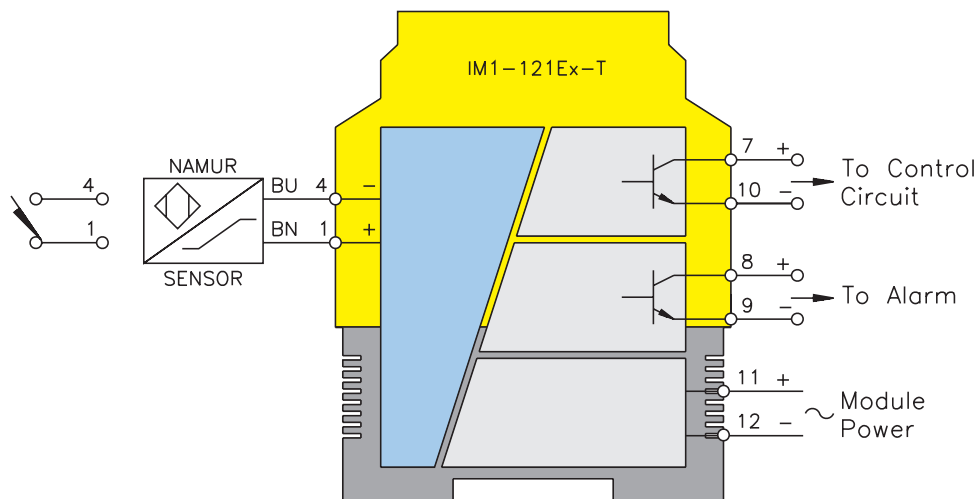

Functional Description:

This 1 channel intrinsically safe interface device is designed to accommodate 1 switch or NAMUR proximity sensor input from a hazardous area and repeat the change of state of the field circuits to a control system located in a non-hazardous area.

The non-hazardous area output is a NPN Transistor reflecting the corresponding input change of state from the field circuit when properly configured.

Features:

- 1 channel input for NAMUR sensors or mechanical switches
- Monitoring of field wiring for open or short-circuit (if required)
- Configuration switches on top of unit for easy access
- 2 isolated short-circuit protected non-hazardous area NPN transistor outputs, 1 for alarm function
- Selectable N.O./N.C. outputs

Electrical Parameters:

Inputs: Hazardous Area

Supply Voltage - (20-250 VAC or 20-125 VDC)
 Inputs (8.2 V, 8.2 mA)
 Switching Threshold 1.55 mA
 Hysteresis Typical 0.2 mA
 Open-circuit Threshold . . . ≤0.1 mA
 Short-circuit Threshold . . . ≥6.0 mA

Outputs: Non-Hazardous Area

2 Transistors, Potential Free Short-Circuit Protected
 Switching Voltage ≤30 VDC
 Switch Current ≤50 mA per channel
 Switch Frequency ≤5 kHz
 Voltage Drop. ≤1.3 V

For entity parameters see control drawings on pages 86-91.

Isolation Switch Relays

IM1-121Ex-T

Pin #	Terminal Function
1	(+) to Field Device
2	No Connection
3	No Connection
4	(-) to Field Device
5	No Connection
6	No Connection
7	Non-Hazardous Area Transistor (+)
8	Non-Hazardous Area Trans Alarm (+)
9	Non-Hazardous Area Trans Alarm (-)
10	Non-Hazardous Area Transistor (-)
11	Module Power (+) or AC
12	Module Power (-) or AC

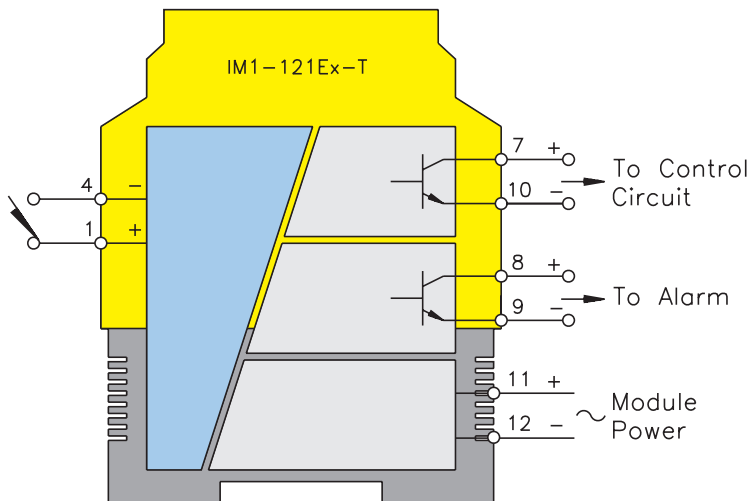
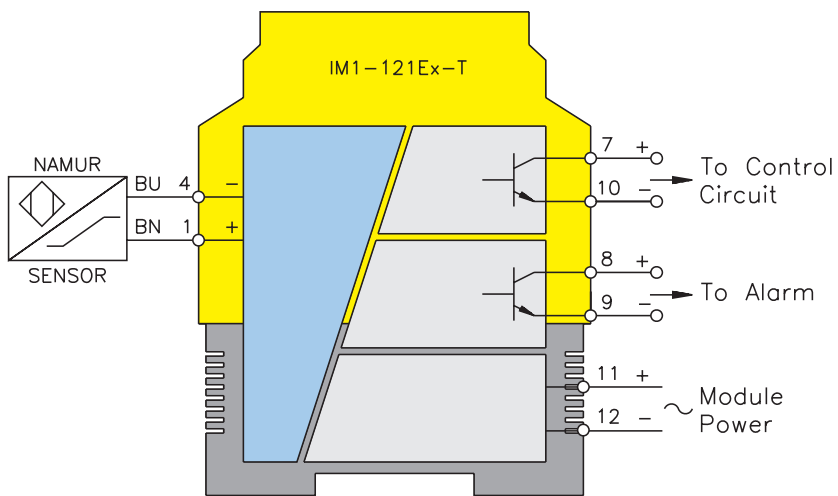

IM1-22Ex-R

Isolation Switch Relays

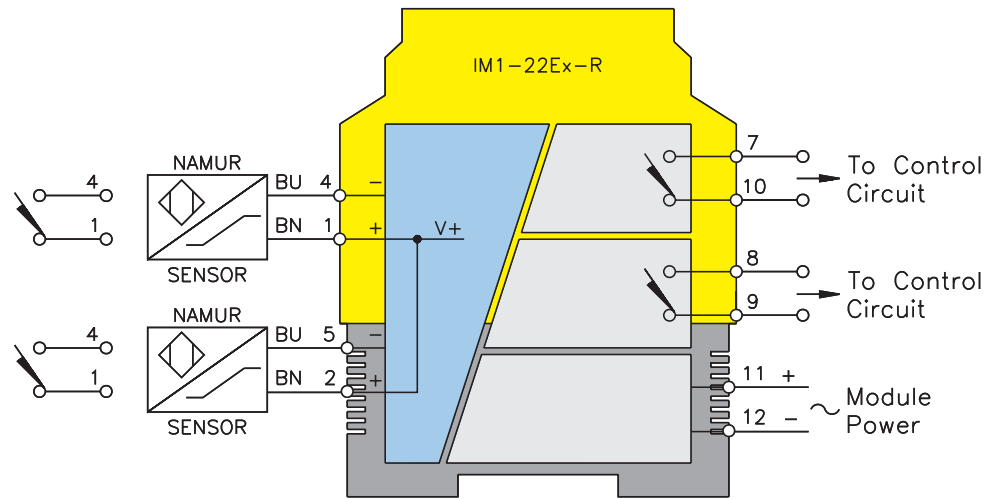

Functional Description:

This 2 channel intrinsically safe interface device is designed to accommodate two switches or NAMUR proximity sensor inputs from a hazardous area and repeat the change of state of the field circuits to a control system located in a non-hazardous area.

The non-hazardous area outputs are two separate SPST switches reflecting the corresponding change of state from each individual input of the field circuit.

Features:

- 2 channel input for NAMUR sensors or mechanical switches
- Monitoring of field wiring for open or short-circuit (if required)
- Configuration switches on top of unit for easy access
- 2 SPST non-hazardous area outputs; 1 for each channel
- Selectable N.O./N.C. outputs

Electrical Parameters:

Inputs: Hazardous Area

Supply Voltage - (20-250 VAC or 20-125 VDC)
 Inputs (8.2 V, 8.2 mA)
 Switching Threshold 1.55 mA
 Hysteresis Typical 0.2 mA
 Open-circuit Threshold ≤0.1 mA
 Short-circuit Threshold ≥6.0 mA

Outputs: Non-Hazardous Area

2 Relays, 1 N.O. Contact Each
 Voltage ≥250 VAC/120 VDC
 Current ≥2 A per channel
 Capacity ≥500 VA / 60 W per channel
 Switch Frequency ≥10 Hz
 Contacts Silver-Alloy + Au (3 micro μ)

For entity parameters see control drawings on pages 86-91.

Isolation Switch Relays

IM1-22Ex-R

Pin #	Terminal Function
1	(+) to Field Device #1
2	(+) to Field Device #2
3	No Connection
4	(-) to Field Device #1
5	(-) to Field Device #2
6	No Connection
7	Non-Hazardous Area Switch #1
8	Non-Hazardous Area Switch #2
9	Non-Hazardous Area Switch #2
10	Non-Hazardous Area Switch #1
11	Module Power (+) or AC
12	Module Power (-) or AC

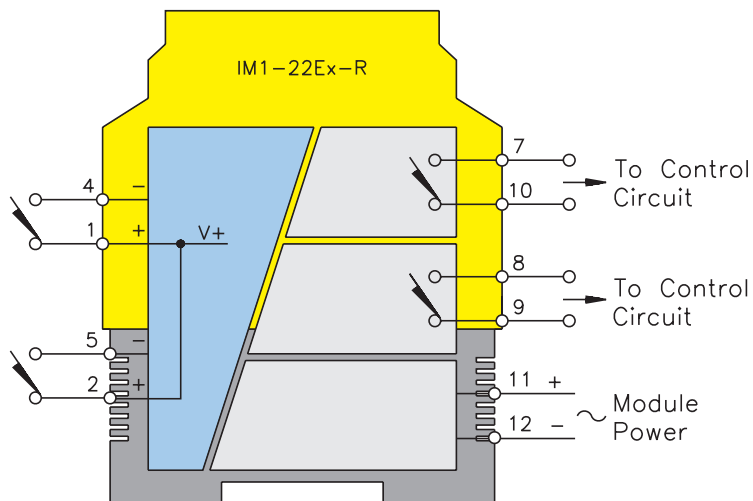
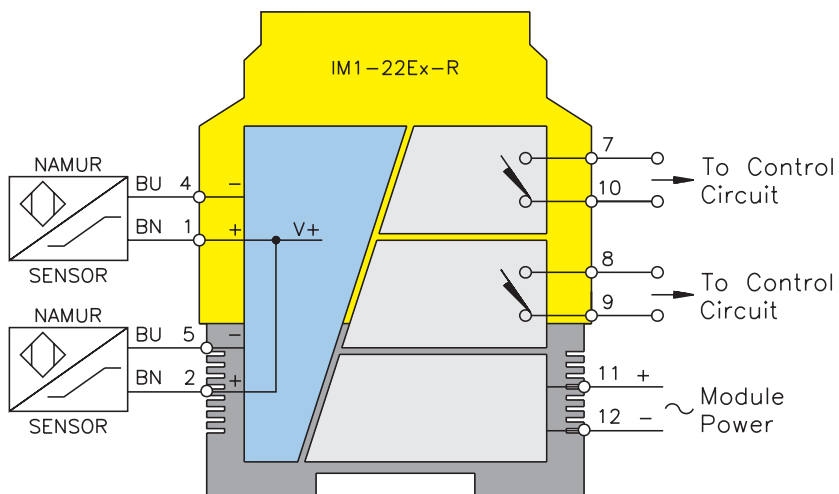

IM1-22Ex-T

Isolation Switch Relays

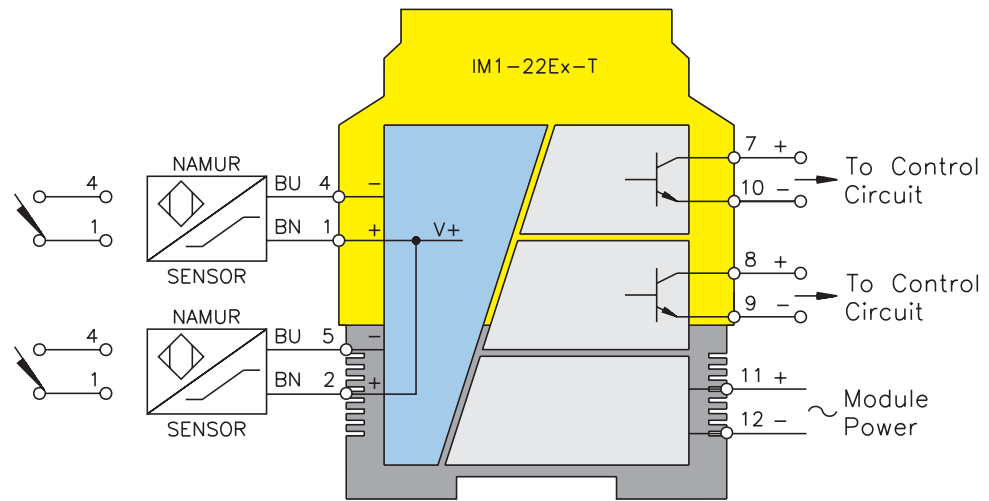

Functional Description:

This 2 channel intrinsically safe interface device is designed to accommodate two switches or NAMUR proximity sensors input from a hazardous area and repeat the change of state of the field circuits to a control system located in a non-hazardous area.

The non-hazardous area outputs are two separate NPN transistors reflecting the corresponding change of state from each individual input of the field circuit when properly configured.

Features:

- 2 channel input for NAMUR sensors or mechanical switches
- Monitoring of field wiring for open or short-circuit (if required)
- Configuration switches on top of unit for easy access
- 2 isolated short-circuit protected NPN transistor non-hazardous area outputs; 1 for each channel
- Selectable N.O./N.C. outputs

Electrical Parameters:

Inputs: Hazardous Area

Supply Voltage - (20-250 VAC or 20-125 VDC)
 Inputs (8.2 V, 8.2 mA)
 Switching Threshold 1.55 mA
 Hysteresis Typical 0.2 mA
 Open-circuit Threshold . . . ≤0.1 mA
 Short-circuit Threshold . . . ≥6.0 mA

Outputs: Non-Hazardous Area

2 Transistors, Potential Free Short-Circuit Protected
 Switching Voltage ≤30 VDC
 Switch Current ≤50 mA per channel
 Switch Frequency ≤5 kHz
 Voltage Drop. ≤1.3 V

For entity parameters see control drawings on pages 86-91.

Isolation Switch Relays

IM1-22Ex-T

Pin #	Terminal Function
1	(+) to Field Device #1
2	(+) to Field Device #2
3	No Connection
4	(-) to Field Device #1
5	(-) to Field Device #2
6	No Connection
7	Non-Hazardous Area Transistor #1 (+)
8	Non-Hazardous Area Transistor #2 (+)
9	Non-Hazardous Area Transistor #2 (-)
10	Non-Hazardous Area Transistor #1 (-)
11	Module Power (+) or AC
12	Module Power (-) or AC

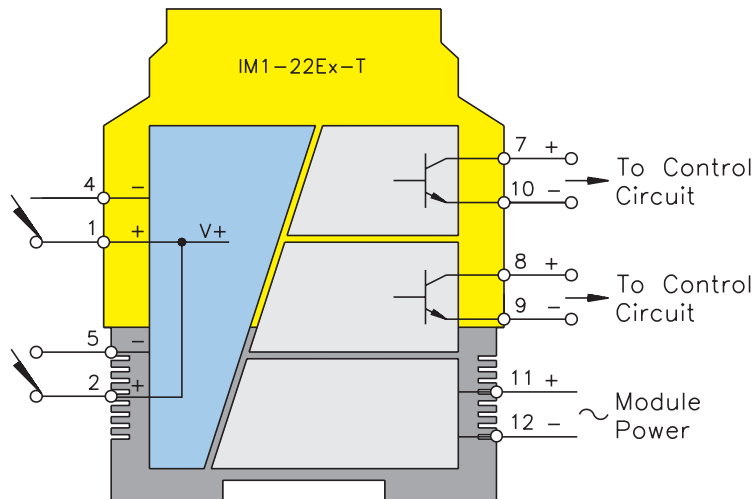
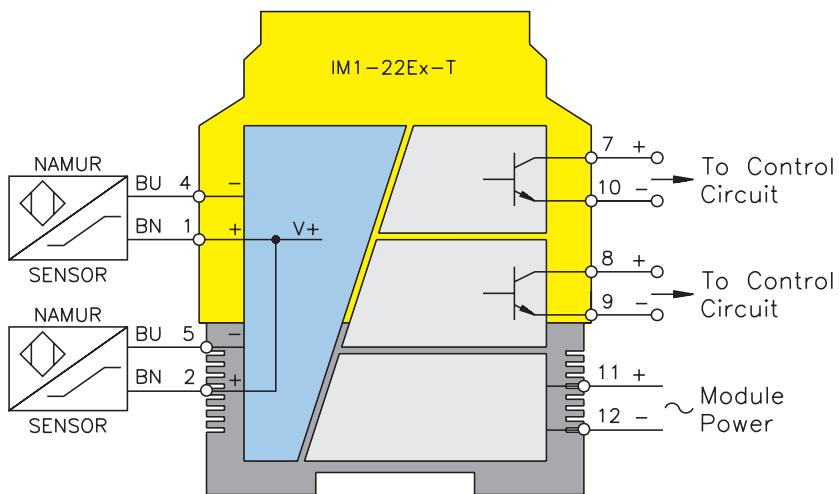

IM1-22Ex-MT

Isolation Switch Relays

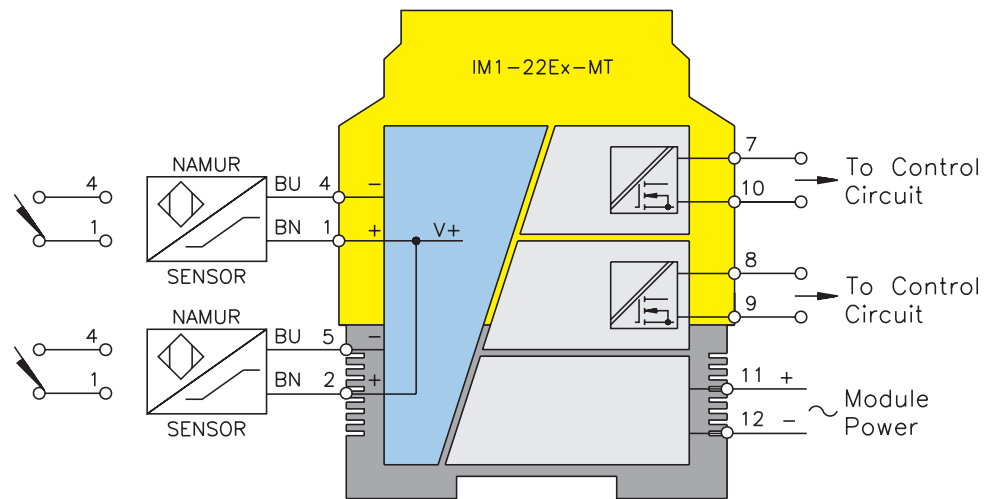

Functional Description:

This 2 channel intrinsically safe interface device is designed to accommodate two switches or NAMUR proximity sensors input from a hazardous area and repeat the change of state of the field circuits to a control system located in a non-hazardous area.

The non-hazardous area outputs are two separate MOSFET transistors reflecting the corresponding change of state from each individual input of the field circuit when properly configured.

Features:

- 2 channel input for NAMUR sensors or mechanical switches
- Monitoring of field wiring for open or short-circuit (if required)
- Configuration switches on top of unit for easy access
- 2 isolated non-hazardous area unipolar MOSFET outputs allow switching voltages up to 250 VAC at a maximum frequency of 1 kHz, 1 for each channel
- Selectable N.O./N.C. outputs

Electrical Parameters:

Inputs: Hazardous Area

Supply Voltage - (20-250 VAC or 20-125 VDC)
 Inputs (8.2 V, 8.2 mA)
 Switching Threshold 1.55 mA
 Hysteresis Typical 0.2 mA
 Open Circuit Threshold . . . ≤0.1 mA
 Short Circuit Threshold. . . ≥6.0 mA

Outputs: Non-Hazardous Area

2 MOSFET, Potential Free
 Switching Voltage ≥250 VAC/120 VDC
 Switch Current ≤90 mA per channel
 Switch Capacity 22.5 VA/10.8 W per channel
 Switch Capacity ≤1 kHz

For entity parameters see control drawings on pages 86-91.

Isolation Switch Relays IM1-22Ex-MT

Pin #	Terminal Function
1	(+) to Field Device
2	(+) to Field Device
3	No Connection
4	(-) to Field Device
5	(-) to Field Device
6	No Connection
7	Non-Hazardous Area MOSFET #1 D
8	Non-Hazardous Area MOSFET #2 D
9	Non-Hazardous Area MOSFET #2 S
10	Non-Hazardous Area MOSFET #1 S
11	Module Power (+) or AC
12	Module Power (-) or AC

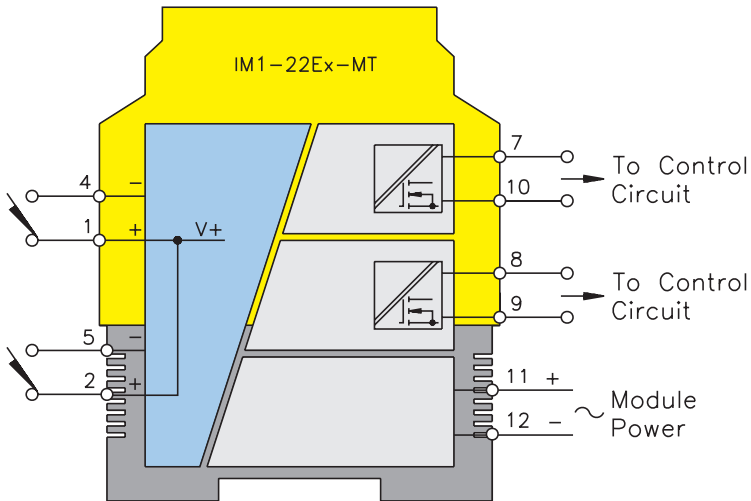
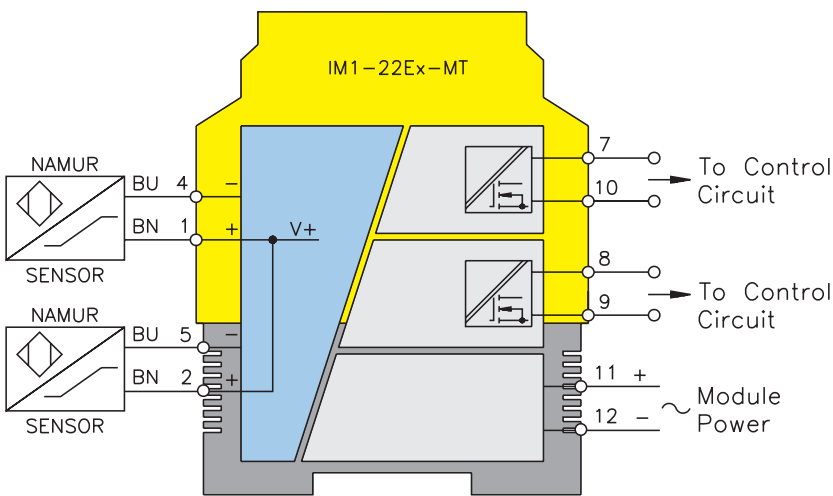

IM1-12Ex-R

Isolation Switch Relays

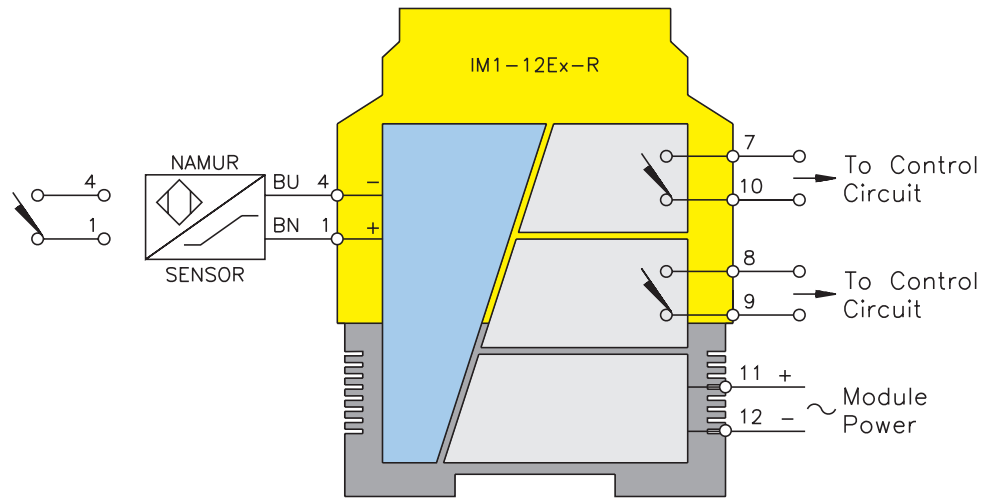

Functional Description:

This 1 channel intrinsically safe interface device is designed to accommodate 1 switch or NAMUR proximity sensor input from a hazardous area and repeat the change of state of the field circuits to a control system located in a non-hazardous area.

The non-hazardous area outputs are two separate SPST switches reflecting the corresponding input change of state from the field circuit.

Features:

- 1 channel input for NAMUR sensors or mechanical switches
- Monitoring of field wiring for open or short-circuit (if required)
- Configuration switches on top of unit for easy access
- 2 non-hazardous area switch outputs; 1 for alarm function
- Selectable N.O./N.C. outputs

Electrical Parameters:

Inputs: Hazardous Area

Supply Voltage - (20-250 VAC or 20-125 VDC)
 Inputs (8.2 V, 8.2 mA)
 Switching Threshold 1.55 mA
 Hysteresis Typical 0.2 mA
 Open-circuit Threshold ≤0.1 mA
 Short-circuit Threshold ≥6.0 mA

Outputs: Non-Hazardous Area

2 Relays, 1 N.O. Contact Each
 Voltage ≥250 VAC/120 VDC
 Current ≥2 A per channel
 Capacity ≥500 VA /60 W per channel
 Switch Frequency ≥10 Hz
 Contacts Silver-Alloy + Au (3 micro μ)

For entity parameters see control drawings on pages 86-91.

Isolation Switch Relays IM1-12Ex-R

Pin #	Terminal Function
1	(+) to Field Device
2	No Connection
3	No Connection
4	(-) to Field Device
5	No Connection
6	No Connection
7	Non-Hazardous Area Switch #1
8	Non-Hazardous Area Switch #2
9	Non-Hazardous Area Switch #2
10	Non-Hazardous Area Switch #1
11	Module Power (+) or AC
12	Module Power (-) or AC

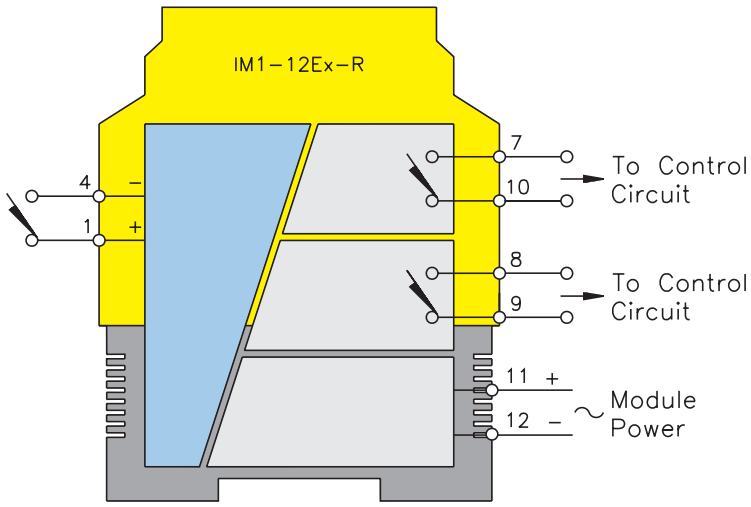
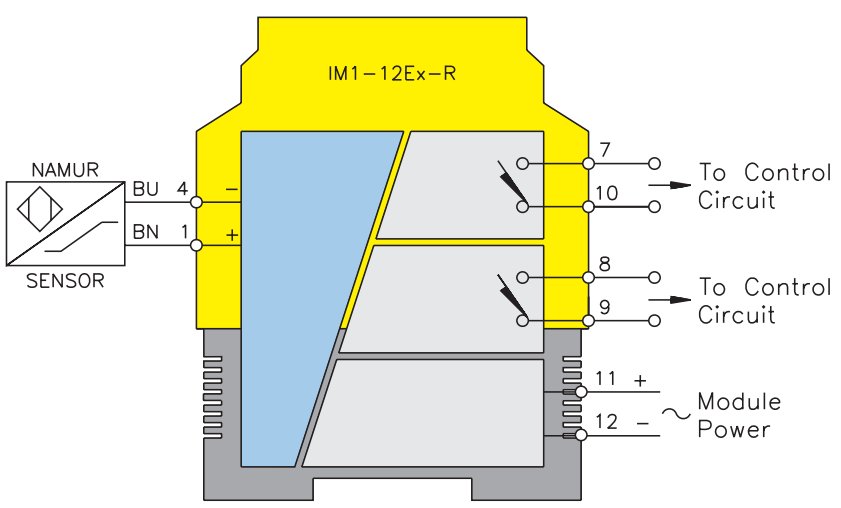

IM1-12Ex-T

Isolation Switch Relays

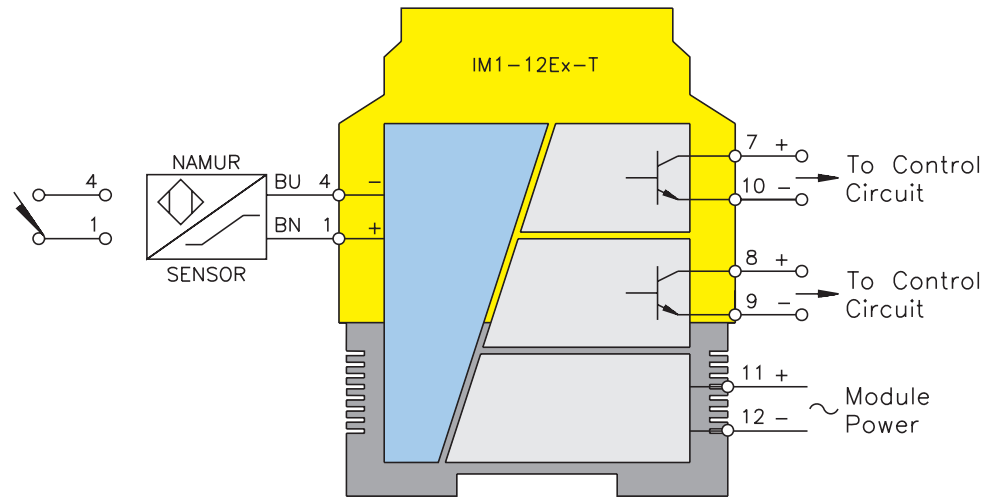

Functional Description:

This 1 channel intrinsically safe interface device is designed to accommodate 1 switch or NAMUR proximity sensor input from a hazardous area and repeat the change of state of the field circuits to a control system located in a non-hazardous area.

The non-hazardous area outputs are two separate NPN transistors reflecting the corresponding input change of state from the field circuit when properly configured.

Features:

- 1 channel input for NAMUR sensors or mechanical switches
- Monitoring of field wiring for open or short-circuit (if required)
- Configuration switches on top of unit for easy access
- 2 isolated short-circuit protected non-hazardous area NPN transistor outputs; 1 for Alarm function
- Selectable N.O./N.C. outputs

Electrical Parameters:

Inputs: Hazardous Area

Supply Voltage - (20-250 VAC or 20-125 VDC)
 Inputs (8.2 V, 8.2 mA)
 Switching Threshold 1.55 mA
 Hysteresis Typical 0.2 mA
 Open-circuit Threshold ≤0.1 mA
 Short-circuit Threshold ≥6.0 mA

Outputs: Non-Hazardous Area

2 Transistors, Potential Free Short-Circuit Protected
 Switching Voltage ≤30 VDC
 Switch Current ≤50 mA per channel
 Switch Frequency ≤5 Hz
 Voltage Drop ≤1.3 V

For entity parameters see control drawings on pages 86-91.

Isolation Switch Relays IM1-12Ex-T

Pin #	Terminal Function
1	(+) to Field Device
2	No Connection
3	No Connection
4	(-) to Field Device
5	No Connection
6	No Connection
7	Non-Hazardous Area Transistor #1
8	Non-Hazardous Area Transistor #2
9	Non-Hazardous Area Transistor #2
10	Non-Hazardous Area Transistor #1
11	Module Power (+) or AC
12	Module Power (-) or AC

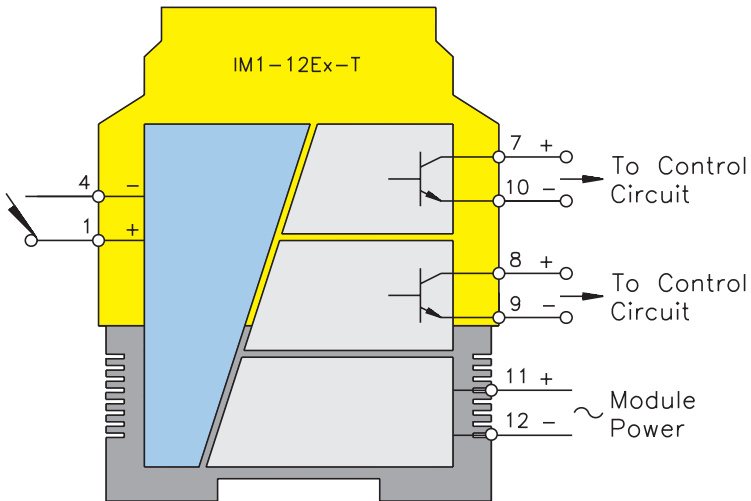
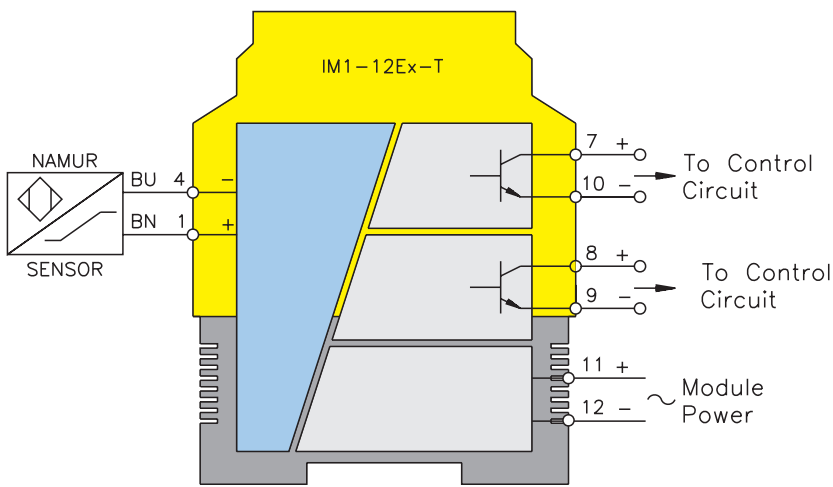

IM1-12Ex-MT

Isolation Switch Relays

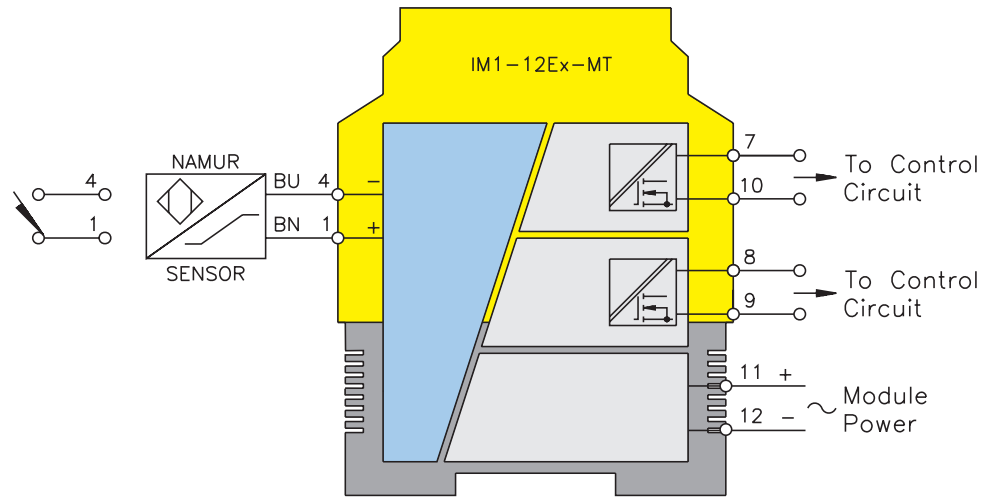

Functional Description:

This 1 channel intrinsically safe interface device is designed to accommodate 1 switch or NAMUR proximity sensor input from a hazardous area and repeat the change of state of the field circuits to a control system located in a non-hazardous area.

The non-hazardous area outputs are two separate MOSFET Transistors reflecting the corresponding input change of state from the field circuit when properly configured.

Features:

- 1 channel input for NAMUR sensors or mechanical switches
- Monitoring of field wiring for open or short-circuit (if required)
- Configuration switches on top of unit for easy access
- 2 isolated non-hazardous area unipolar MOSFET outputs allow switching voltages up to 250 VAC at a maximum frequency of 1 kHz
- Selectable N.O./N.C. outputs

Electrical Parameters:

Inputs: Hazardous Area

Supply Voltage - (20-250 VAC or 20-125 VDC)
 Inputs (8.2 V, 8.2 mA)
 Switching Threshold 1.55 mA
 Hysteresis Typical 0.2 mA
 Open-circuit Threshold . . . ≤0.1 mA
 Short-circuit Threshold . . . ≥6.0 mA

Outputs: Non-Hazardous Area

2 MOSFET, Potential Free
 Switch Current ≤90 mA per channel
 Switch Capacity 22.5 VA/10.8 W per channel
 Switch Capacity ≤1 kHz

For entity parameters see control drawings on pages 86-91.

Isolation Switch Relays

IM1-12Ex-MT

Pin #	Terminal Function
1	(+) to Field Device
2	No Connection
3	No Connection
4	(-) to Field Device
5	No Connection
6	No Connection
7	Non-Hazardous Area MOSFET #1 D
8	Non-Hazardous Area MOSFET #2 D Alarm
9	Non-Hazardous Area MOSFET #2 S Alarm
10	Non-Hazardous Area MOSFET #1 S
11	Module Power (+) or AC
12	Module Power (-) or AC

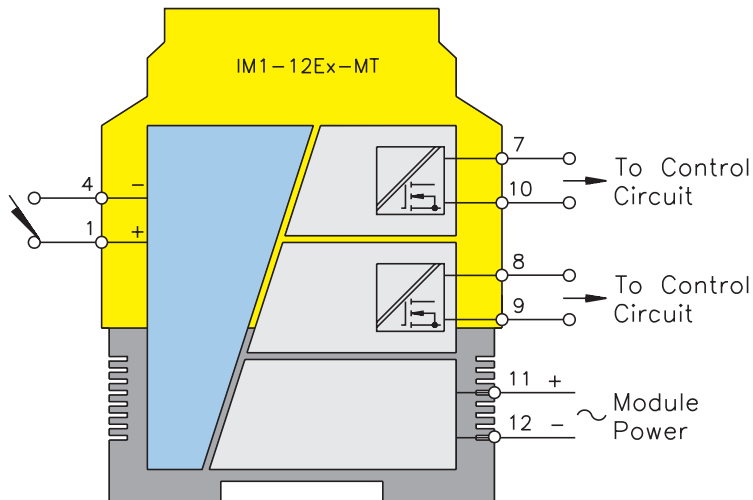
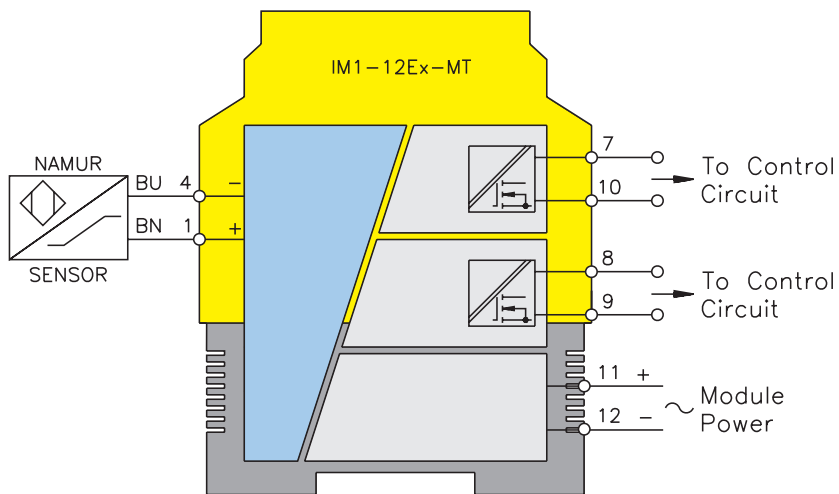

IM1-451Ex-R

Isolation Switch Relays

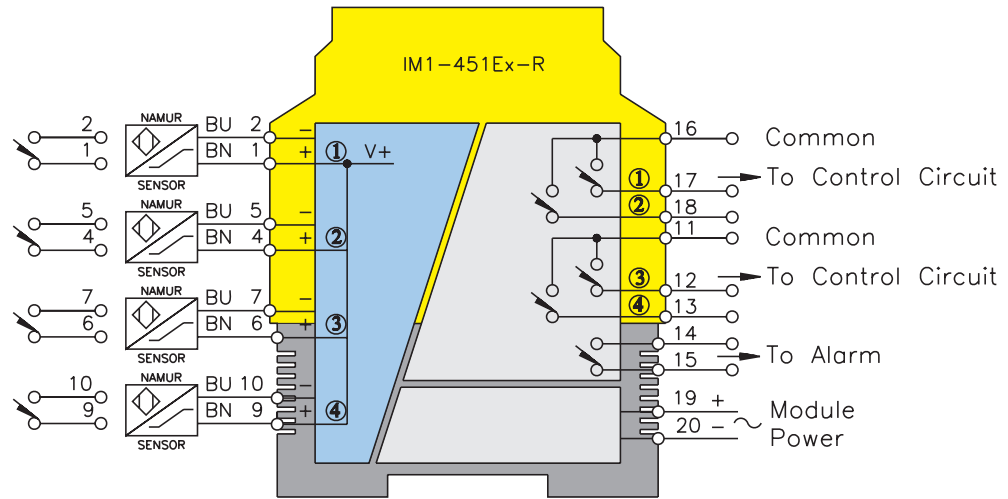

Functional Description:

This 4 channel intrinsically safe interface device is designed to accommodate four switches or NAMUR proximity sensor inputs or any combination of the two from a hazardous area and repeat the change of state of the field circuits to a control system located in a non-hazardous area.

The non-hazardous area outputs are four separate SPST switches reflecting the corresponding change of state from each individual input of the field circuit, to its appropriate corresponding output.

A common alarm switch for all four channels is also incorporated.

Features:

- 4 channel input for NAMUR sensors or mechanical switches
- Monitoring of field wiring for open or short-circuit (if required)
- Configuration switches on top of unit for easy access
- 4 SPST non-hazardous area outputs; 1 for each channel and 1 common alarm
- Selectable N.O./N.C. outputs

Electrical Parameters:

Inputs: Hazardous Area

Supply Voltage - (20-250 VAC or 20-125 VDC)
 Inputs (8.2 V, 8.2 mA)
 Switching Threshold 1.55 mA
 Hysteresis Typical 0.2 mA
 Open-circuit Threshold . . . ≤0.1 mA
 Short-circuit Threshold . . . ≥6.0 mA

Outputs: Non-Hazardous Area

5 Relays, 1 N.O. Contact Each
 Switching Voltage ≤250 VAC/120 VDC
 Switch Current ≤3 A per channel
 Switch Capacity ≤750 VAC per channel
 Switch Frequency ≤10 kHz
 Contacts Silver-Alloy + Au (3 micro μ)

For entity parameters see control drawings on pages 86-91.

Isolation Switch Relays IM1-451Ex-R

Pin #	Terminal Function
1	(+) to Field Device #1
2	(-) to Field Device #1
3	No Connection
4	(+) to Field Device #2
5	(-) to Field Device #2
6	(+) to Field Device #3
7	(-) to Field Device #3
8	No Connection
9	(+) to Field Device #4
10	(-) to Field Device #4

Pin #	Terminal Function
11	Non-Hazardous Area Sw 3 & 4 common
12	Non-Hazardous Area Switch #3 (-)
13	Non-Hazardous Area Switch #4 (-)
14	Non-Hazardous Area Switch Alarm
15	Non-Hazardous Area Switch Alarm
16	Non-Hazardous Area Sw 1 & 2 common
17	Non-Hazardous Area Switch #1 (-)
18	Non-Hazardous Area Switch #2 (-)
19	Module Power (+) or AC
20	Module Power (-) or AC

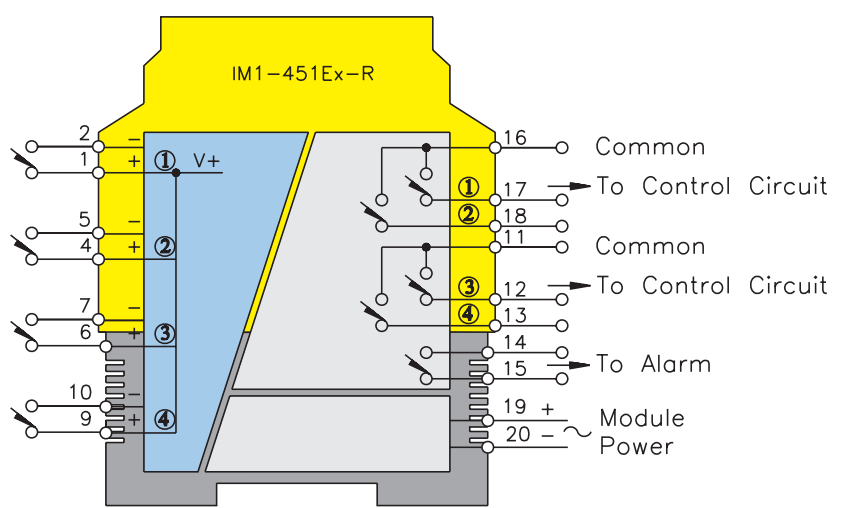
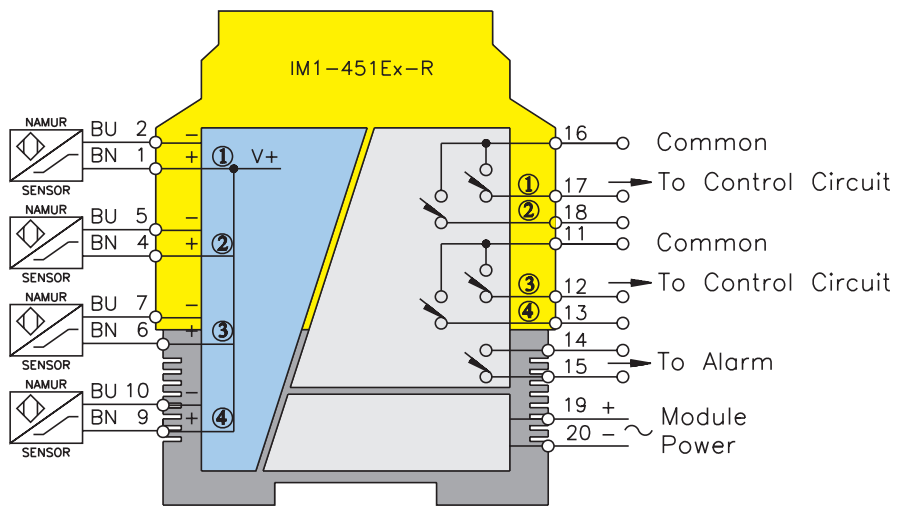

IM1-451Ex-T

Isolation Switch Relays

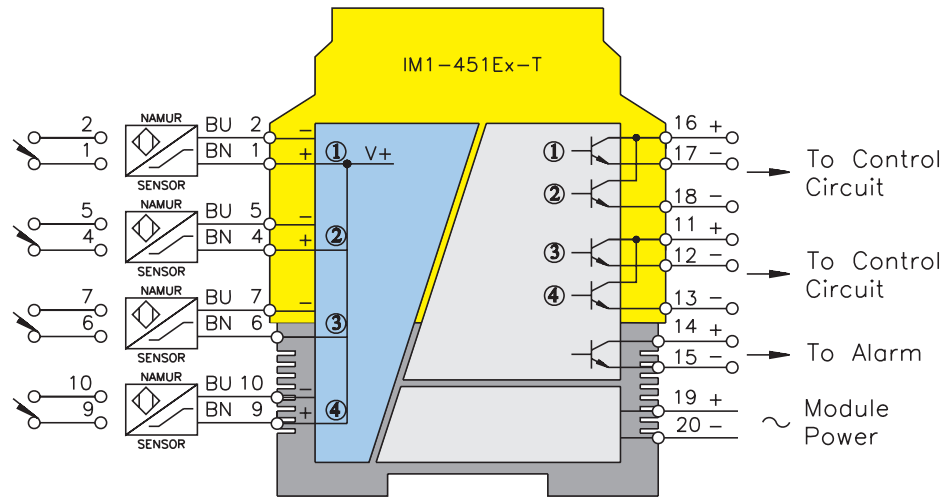

Functional Description:

This 4 channel intrinsically safe interface device is designed to accommodate four switches or NAMUR proximity sensor inputs or any combination of the two from a hazardous area and repeat the change of state of the field circuits to a control system located in a non-hazardous area.

The non-hazardous area outputs are four separate open collector transistors reflecting the corresponding change of state from each individual input of the field circuit, to its appropriate corresponding output when appropriately configured.

A common alarm transistor for all four channels is also incorporated.

Features:

- 4 channel input for NAMUR sensors or mechanical switches
- Monitoring of field wiring for open or short-circuit (if required)
- Configuration switches on top of unit for easy access
- 2 isolated short-circuit protected NPN transistor non-hazardous area outputs; 1 for each channel and 1 alarm
- Selectable N.O./N.C. outputs

Electrical Parameters:

Inputs: Hazardous Area

Supply Voltage - (20-250 VAC or 20-125 VDC)
 Inputs (8.2 V, 8.2 mA)
 Switching Threshold 1.55 mA
 Hysteresis Typical 0.2 mA
 Open-circuit Threshold . . . ≤0.1 mA
 Short-circuit Threshold . . . ≥6.0 mA

Outputs: Non-Hazardous Area

5 Transistors, Potential Free Short-Circuit Protected
 Switching Voltage ≤30 VDC
 Switch Current ≤50 mA per channel
 Switch Frequency ≤3 kHz
 Voltage Drop. ≤2.5 V

For entity parameters see control drawings on pages 86-91.

Isolation Switch Relays IM1-451Ex-T

Pin #	Terminal Function
1	(+) to Field Device #1
2	(-) to Field Device #1
3	No Connection
4	(+) to Field Device #2
5	(-) to Field Device #2
6	(+) to Field Device #3
7	(-) to Field Device #3
8	No Connection
9	(+) to Field Device #4
10	(-) to Field Device #4

Pin #	Terminal Function
11	(+) Non-Hazardous Area Trans 3 & 4
12	Non-Hazardous Area Transistor #3 (-)
13	Non-Hazardous Area Transistor #4 (-)
14	Non-Hazardous Area Trans Alarm (+)
15	Non-Hazardous Area Trans Alarm (-)
16	(+) Non-Hazardous Area Trans 1 & 2
17	Non-Hazardous Area Transistor #1 (-)
18	Non-Hazardous Area Transistor #2 (-)
19	Module Power (+) or AC
20	Module Power (-) or AC

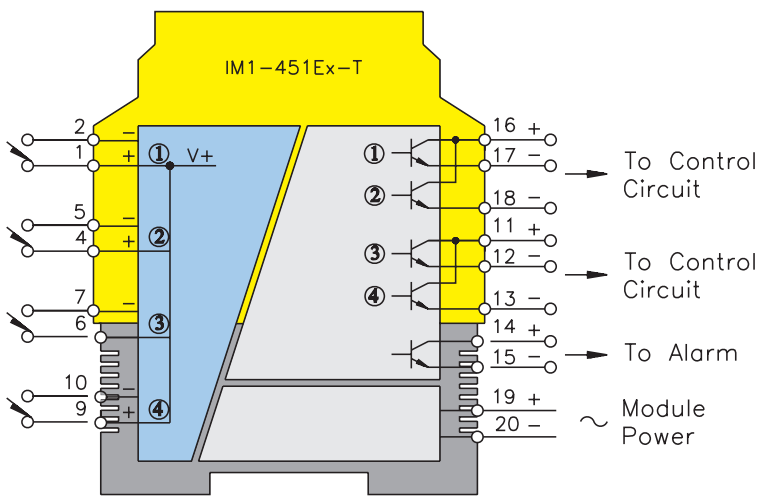
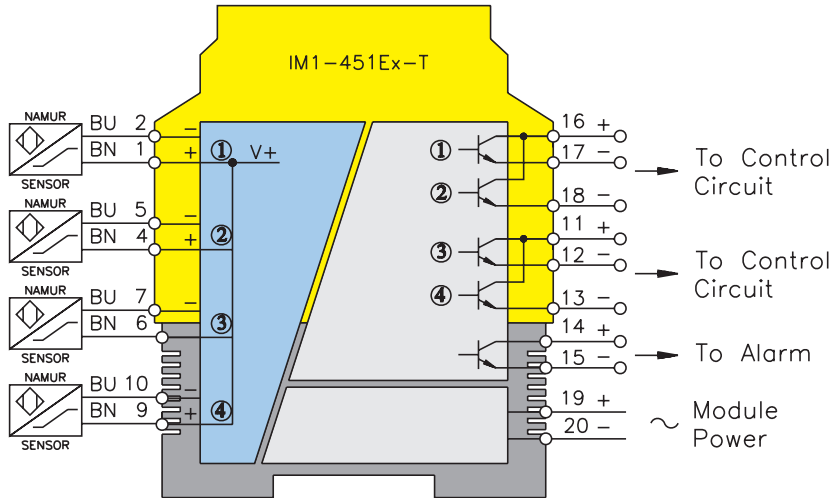

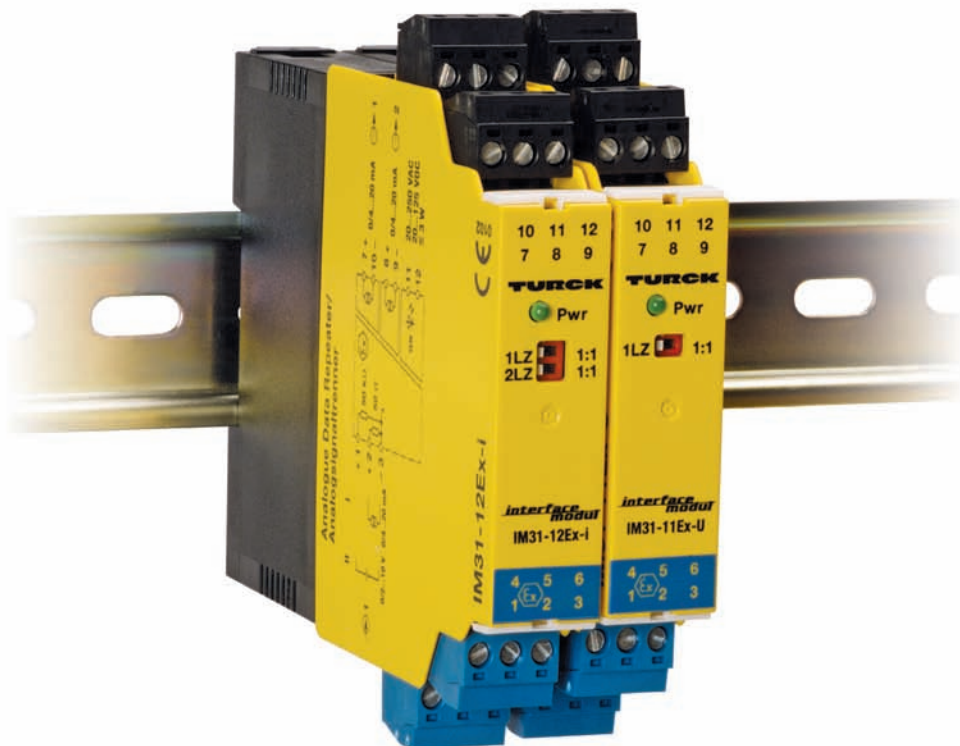

Analog Data Transmitters

Analog data transmitters are a selection of devices that allow the transmission of hazardous area analog signals to a non-hazardous area as a direct one-to-one, or with a slight variation that is sometimes desired for specific applications.

The Analog Isolating Transmitters can transfer 4/20 mA, 0/20 mA, 0-10 V or 2-10 V signals from a hazardous area and repeat the signal in the non-hazardous area either as a current or a voltage signal; 2 current signals or a 2 channel one-to-one combination, depending on the module.

These devices offer a much requested and much desired mix of inputs and outputs that are sometimes difficult to achieve with conventional intrinsically safe interface devices. Flexibility is a key feature of these devices, with the option to convert from voltage to current or from current to voltage where required. The multi-channel device also provides a compact high-density solution for applications where space is an issue.

Analog Data Transmitters

Part Number Key

Part Number Keys are to assist in IDENTIFICATION ONLY. Consult Factory for catalog items not identified.

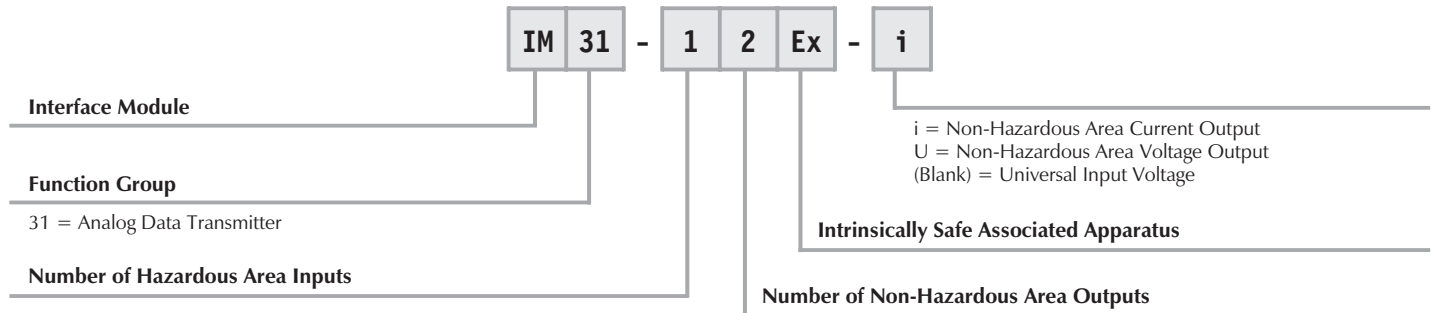

Extension Examples:

IM31-12Ex-i

Interface Module
Analog Data Transmitter
Single Channel Input
2 Non-Hazardous Area Current Outputs
Intrinsically Safe Associated Apparatus
Non-Hazardous Area Current Output

IM31-11Ex-U

Interface Module
Analog Data Transmitter
Single Channel Input
1 Non-Hazardous Area Current Outputs
Intrinsically Safe Associated Apparatus
Non-Hazardous Area Voltage Output

IM31-22Ex-U

Interface Module
Analog Data Transmitter
2 Channel Input
2 Non-Hazardous Area Current Outputs
Intrinsically Safe Associated Apparatus
Non-Hazardous Area Current Output

IM31-11Ex-i

Analog Data Transmitters

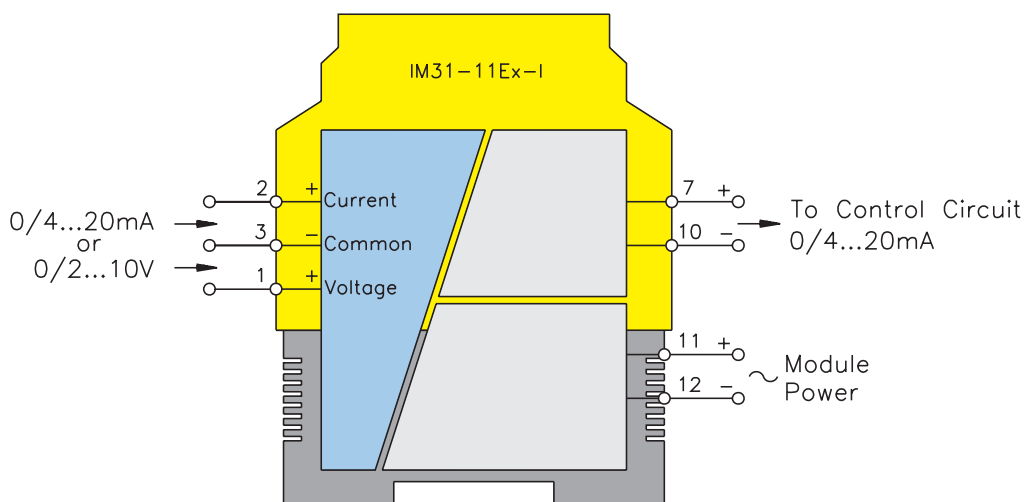

Functional Description:

This 1 channel intrinsically safe interface will receive either a 4/20 mA or 0/2-10 V signal from a hazardous area and repeat the signal in the non-hazardous area as either a 0/20 mA or 4/20 mA signal reflecting the hazardous area input. It will drive a non-hazardous area load of up to 500 Ω.

In switch position "1:1" the hazardous area inputs are reflected one-to-one in the non-hazardous area. In position "LZ" a dead-zero signal (0-10 V or 0/20 mA) input is reflected as a live-zero signal (4/20 mA) output.

Features:

- 1 channel analog data transfer/converter
- Choice of input signal voltage or current
- Choice of output signal voltage or current
- Short-circuit protected output

Electrical Parameters:

Inputs: Hazardous Area

Supply Voltage - (20-250 VAC or 20-125 VDC)
 Inputs 0-10 V (≤ 20 V)
 Input Resistance 50 K Ω
 Current 0-20 mA (≤ 40 mA)
 Input Resistance 50 Ω

Outputs: Non-Hazardous Area

0/4-20 mA
 Load ≤500 Ω

For entity parameters see control drawings on pages 86-91.

Analog Data Transmitters

IM31-11Ex-i

Pin #	Terminal Function
1	(+) 0/2-10 V Field Input
2	(+) 0/4-20 mA Field Input
3	(-) 0/2-10 V Field Input
3	(-) 0/4-20 mA Field Input
4	No Connection
5	No Connection
6	No Connection
7	(+) 0/4-20 mA Non-Hazardous Area Output
8	No Connection
9	No Connection
10	(-) 0/4-20 mA Non-Hazardous Area Output
11	Module Power (+) or AC
12	Module Power (-) or AC

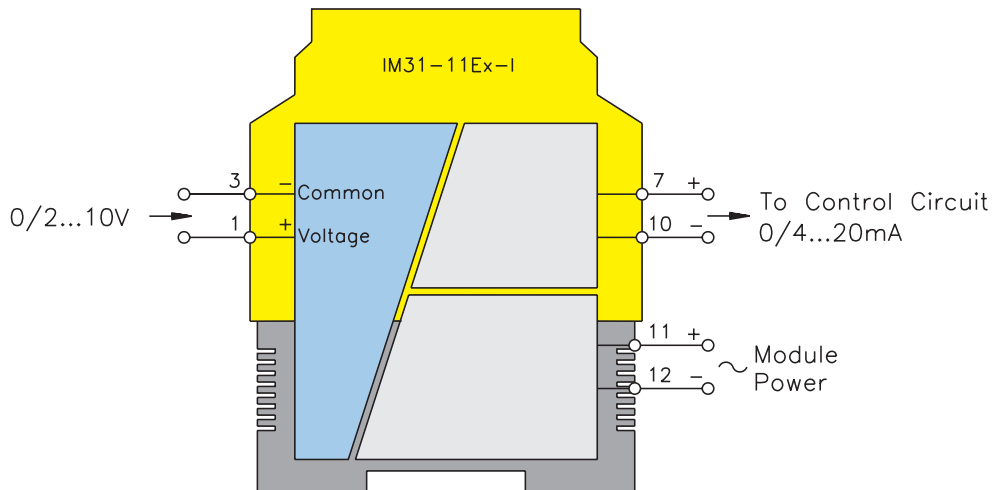
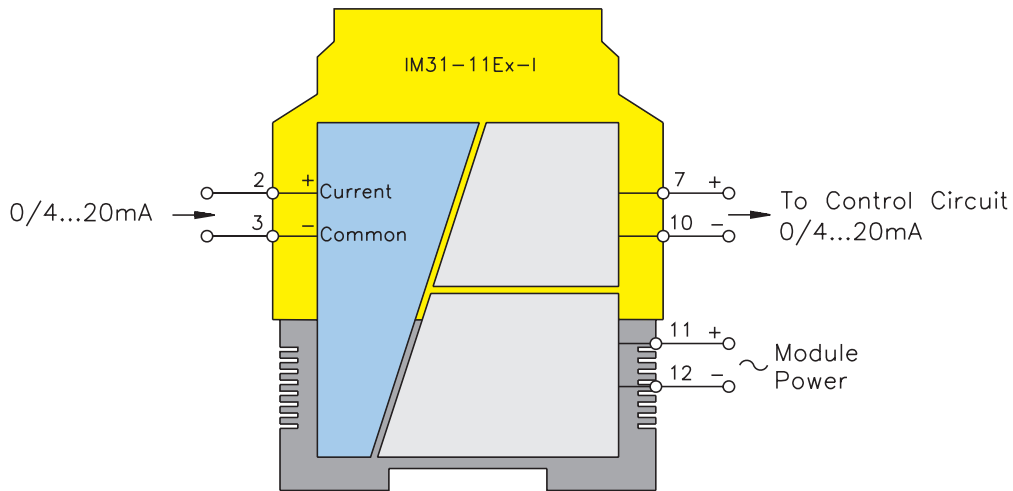

IM31-11Ex-U

Analog Data Transmitters

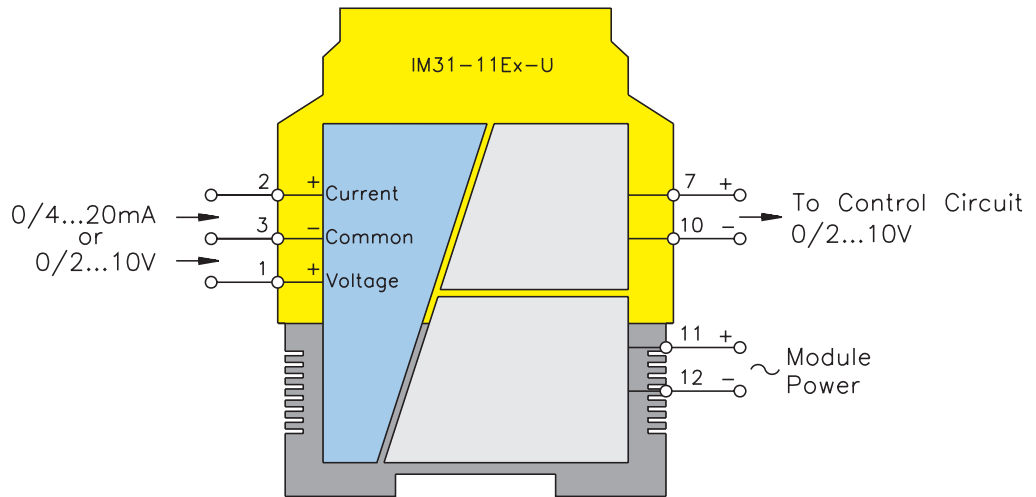

Functional Description:

This 1 channel intrinsically safe interface will receive either a 4/20 mA or 0/2-10 V signal from a hazardous area and repeat the signal in the non-hazardous area as a 0-10 V signal reflecting the hazardous area input. It will drive a non-hazardous area load of up to 500 Ω.

In switch position "1:1" the hazardous area inputs are reflected one-to-one in the non-hazardous area. In position "LZ" a dead-zero signal (0/2-10 V or 0/20 mA) input is reflected as a live-zero signal (0/2-10 V) output.

Features:

- 1 channel analog data transfer/converter
- Choice of input signal voltage or current
- 0/2-10 V output signal
- Short-circuit protected output

Electrical Parameters:

Inputs: Hazardous Area

Supply Voltage - (20-250 VAC or 20-125 VDC)
 Inputs 0/2-10 V (≤20 V)
 Input Resistance 50 K Ω
 Current 0-20 mA (≤40 mA)
 Input Resistance 50 Ω

Outputs: Non-Hazardous Area

0/2-10 V
 Load ≤500 Ω

For entity parameters see control drawings on pages 86-91.

Analog Data Transmitters IM31-11Ex-U

Pin #	Terminal Function
1	(+) 0/2-10 V Field Input
2	(+) 0/4-20 mA Field Input
3	(-) 0/2-10 V Field Input
3	(-) 0/4-20 mA Field Input
4	No Connection
5	No Connection
6	No Connection
7	(+) 0/2-10 V Non-Hazardous Area Output
8	No Connection
9	No Connection
10	(-) 0/2-10 V Non-Hazardous Area Output
11	Module Power (+) or AC
12	Module Power (-) or AC

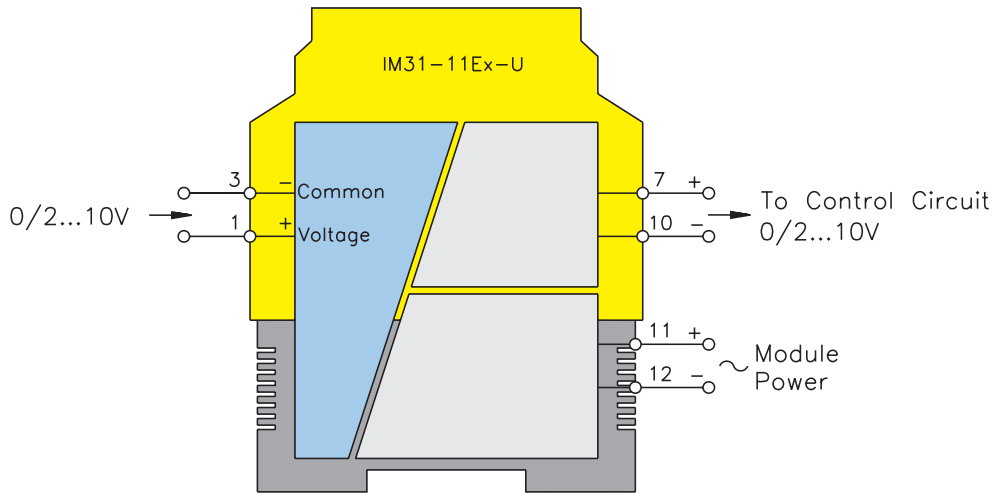
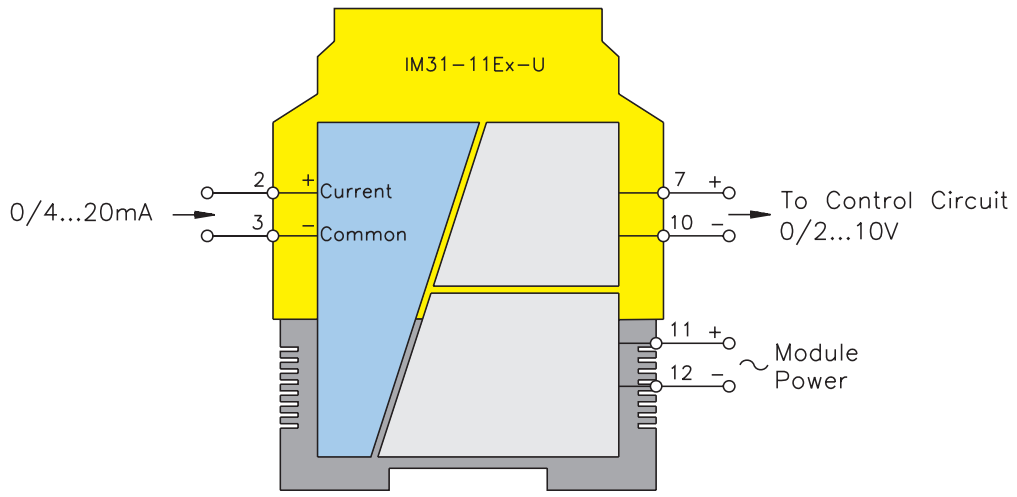

IM31-12Ex-i

Analog Data Transmitters

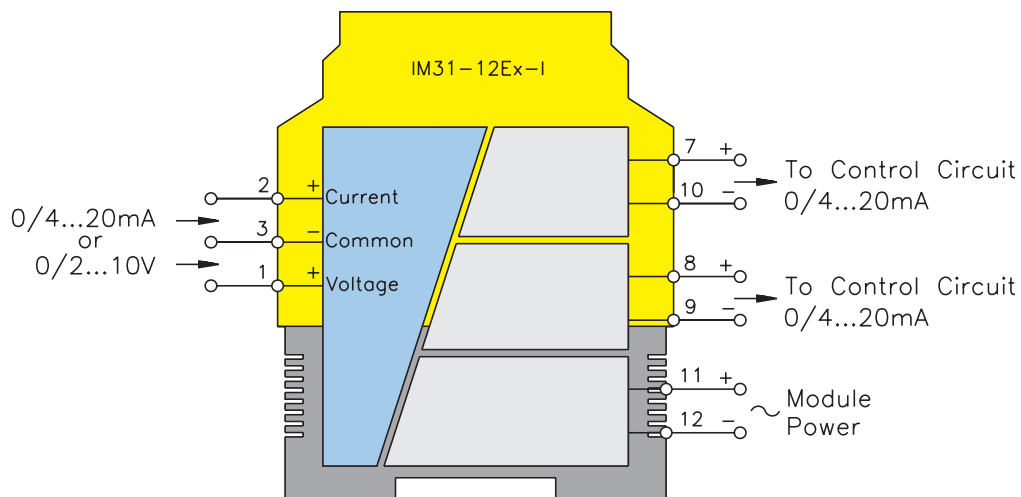

Functional Description:

This 1 channel intrinsically safe interface will receive either a 4/20 mA or 0/2-10 V signal from a hazardous area and repeat the signal in the non-hazardous area as 2 separate 0/20 mA or 4/20 mA signals reflecting the hazardous area input. It will drive 2 separate non-hazardous area loads of up to 500 Ω each.

In switch position "1:1" the hazardous area inputs are reflected one-to-one in the non-hazardous area. In position "LZ" a dead-zero signal (0-10 V or 0/20 mA) input is reflected as 2 separate live-zero signal (4/20 mA) outputs.

Features:

- 1 channel analog data transfer/converter
- Choice of input signal voltage or current
- "2", 0/4-20 mA current output signals
- Short-circuit protected outputs

Electrical Parameters:

Inputs: Hazardous Area

Supply Voltage - (20-250 VAC or 20-125 VDC)
 Inputs 0-10 V (≤ 20 V)
 Input Resistance 50 K Ω
 Current 0-20 mA (≤ 40 mA)
 Input Resistance 50 Ω

Outputs: Non-Hazardous Area

0/4-20 mA
 Load ≤ 500 Ω

For entity parameters see control drawings on pages 86-91.

Analog Data Transmitters IM31-12Ex-i

Pin #	Terminal Function
1	(+) 0/2-10 V Field Input
2	(+) 0/4-20 mA Field Input
3	(-) 0/2-10 V Field Input
3	(-) 0/4-20 mA Field Input
4	No Connection
5	No Connection
6	No Connection
7	(+) 0/4-20 mA Non-Hazardous Area Output #1
8	(+) 0/4-20 mA Non-Hazardous Area Output #2
9	(-) 0/4-20 mA Non-Hazardous Area Output #2
10	(-) 0/4-20 mA Non-Hazardous Area Output #1
11	Module Power (+) or AC
12	Module Power (-) or AC

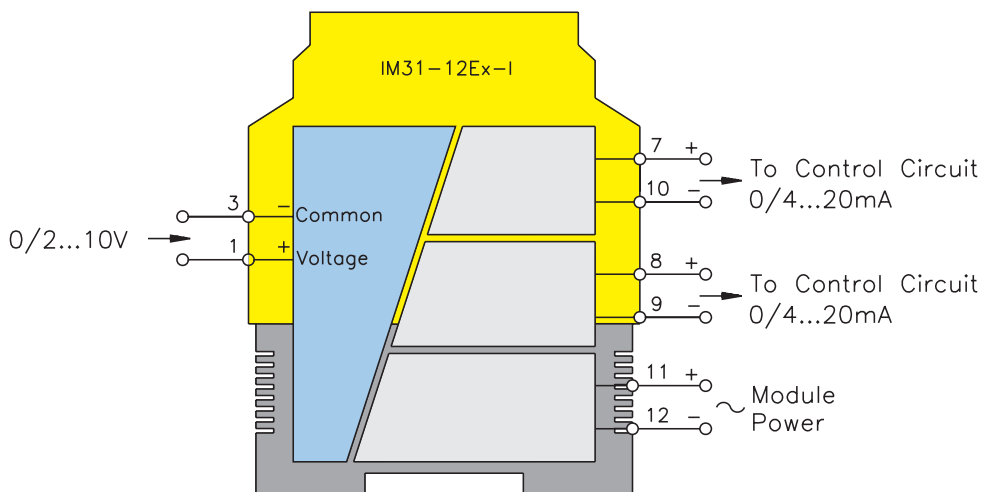
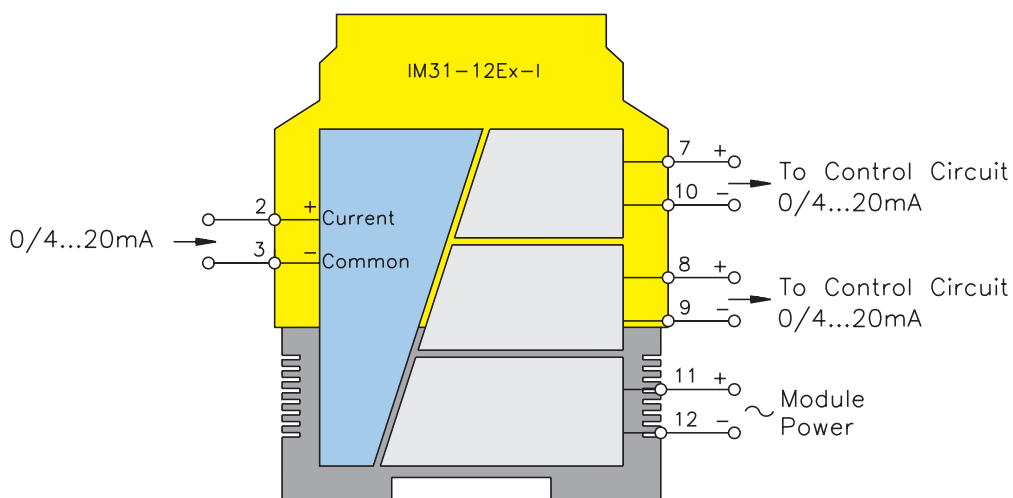

IM31-22Ex-i

Analog Data Transmitters

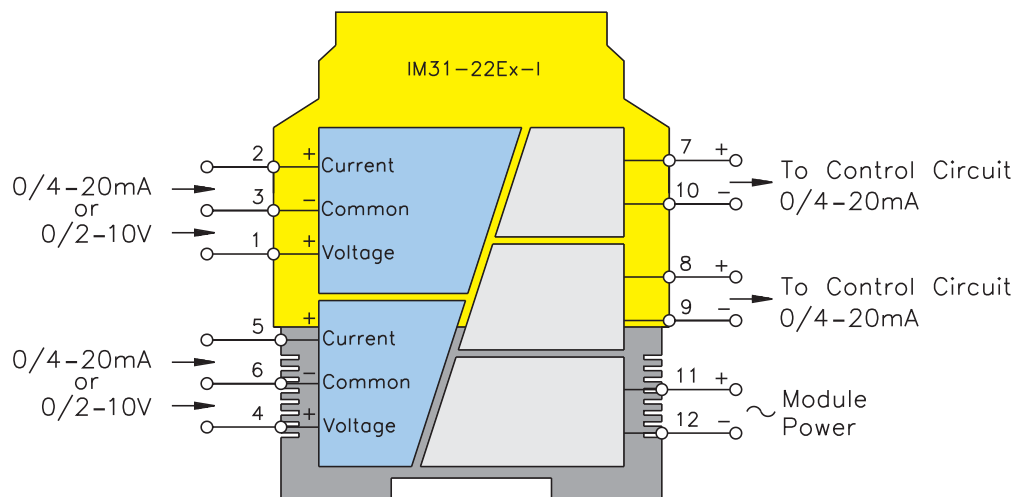

Functional Description:

This 2 channel intrinsically safe interface will receive either a 4/20 mA or 0/2-10 V signal from 2 separate hazardous area signals and repeat the signal in the non-hazardous area as either a 0/20 mA or 4/20 mA signal reflecting its corresponding hazardous area input. It will drive a non-hazardous area load of up to 500 Ω for each for each channel.

In switch position "1:1" the hazardous area inputs are reflected one-to-one in the non-hazardous area. In position "LZ" a dead-zero signal (0-10 V or 0/20 mA) input is reflected as a live-zero signal (4/20 mA) output, 1 for each separate channel.

Features:

- 2 channel analog data transfer/converter
- Choice of input signals voltage, current or combination
- 0/2-20 mA outputs, 1 per input
- Short-circuit protected outputs

Electrical Parameters:

Inputs: Hazardous Area

Supply Voltage - (20-250 VAC or 20-125 VDC)
 Inputs 0-10 V (≤ 20 V)
 Input Resistance 50 K Ω
 Current 0-20 mA (≤ 40 mA)
 Input Resistance 50 Ω

Outputs: Non-Hazardous Area

0/4-20 mA
 Load ≤ 500 Ω

For entity parameters see control drawings on pages 86-91.

Analog Data Transmitters IM31-22Ex-i

Pin #	Terminal Function
1	(+) 0/2-10 V Field Input 1
2	(+) 0/4-20 mA Field Input 1
3	(-) 0/2-10 V Field Input 1
3	(-) 0/4-20 mA Field Input 1
4	(+) 0/2-10 V Field Input 2
5	(+) 0/4-20mA Field Input 2
6	(-) 0/2-10 V Field Input 2
6	(-) 0/4-20 mA Field Input 2
7	(+) 0/4-20mA Non-Hazardous Area Output 1
8	(+) 0/4-20mA Non-Hazardous Area Output 2
9	(-) 0/4-20mA Non-Hazardous Area Output 2
10	(-) 0/4-20mA Non-Hazardous Area Output 1
11	Module Power (+) or AC
12	Module Power (-) or AC

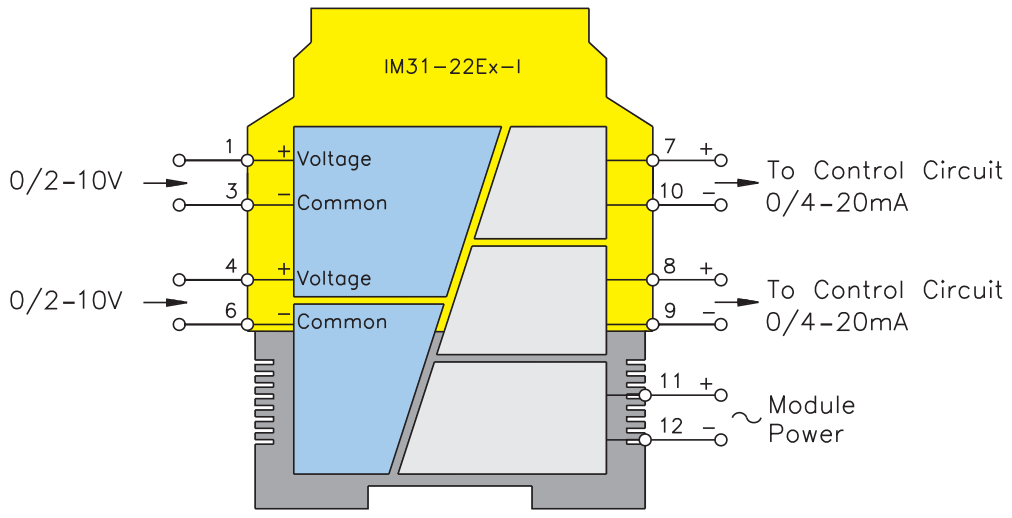
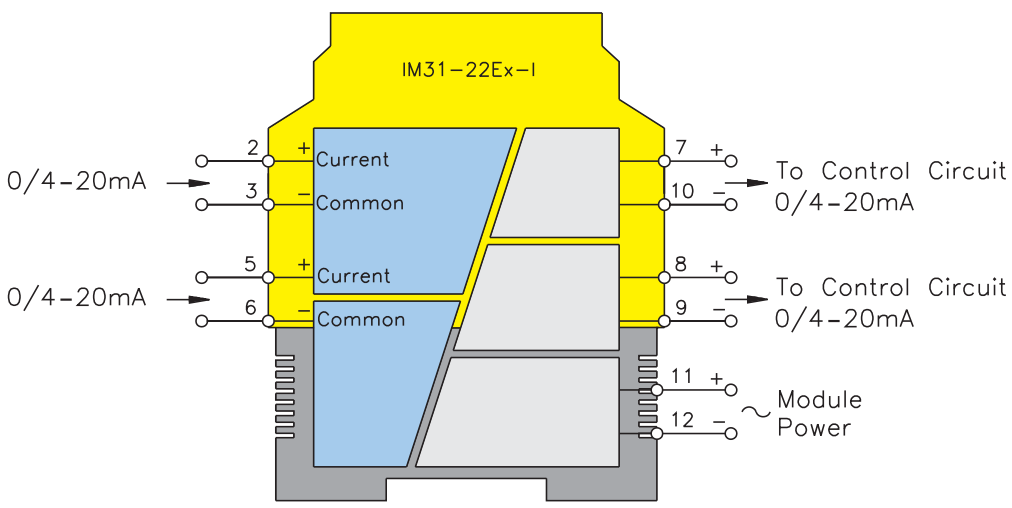

IM31-22Ex-U

Analog Data Transmitters

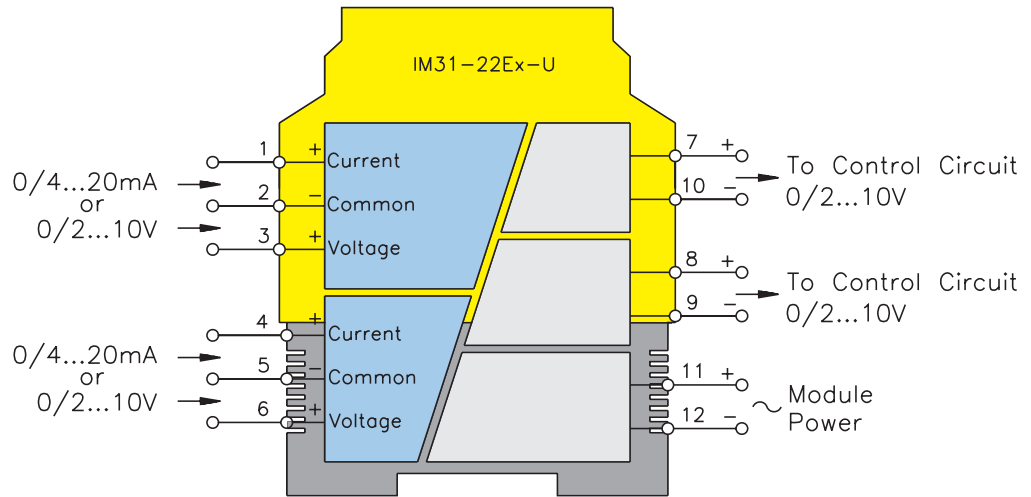

Functional Description:

This 2 channel intrinsically safe interface will receive either a 4/20 mA or 0/2-10 V signal from 2 separate hazardous area signals and repeat the signal in the non-hazardous area, t, as either a 0/2-10 V signal reflecting its corresponding hazardous area input. It will drive a non-hazardous area load of up to 500 Ω for each for each channel.

In switch position "1:1" the hazardous area inputs are reflected one-to-one in the non-hazardous area. In position "LZ" a dead-zero signal (0/2-10 V or 0/20 mA) input is reflected as a live-zero signal (4/20 mA) output, 1 for each separate channel.

Features:

- 2 channel analog data transfer/converter
- Choice of input signals voltage, current or combination
- 0/2-10 V outputs, 1 per input
- Short-circuit protected outputs

Electrical Parameters:

Inputs: Hazardous Area

Supply Voltage - (20-250 VAC or 20-125 VDC)
 Inputs 0/2-10 V (≤20 V)
 Input Resistance 50 K Ω
 Current 0-20 mA (≤40 mA)
 Input Resistance 50 Ω

Outputs: Non-Hazardous Area

0/2-10 V
 Load ≤500 Ω

For entity parameters see control drawings on pages 86-91.

Analog Data Transmitters

IM31-22Ex-U

Pin #	Terminal Function
1	(+) 0/2-10 V Field Input
2	(-) 0/4-20 mA Field Input
2	(-) 0/2-10 V Field Input
3	(+) 0/2-10 V Field Input
4	(+) 0/4-20 mA Field Input
5	(-) 0/4-20 mA Field Input
5	(-) 0/2-10 V Field Input
6	(+) 0/2-10 V Field Input
7	(-) 0/2-10 V Non-Hazardous Area Output
8	(+) 0/2-10 V Non-Hazardous Area Output
9	(-) 0/2-10 V Non-Hazardous Area Output
10	(+) 0/2-10 V Non-Hazardous Area Output
11	Module Power (+) or AC
12	Module Power (-) or AC

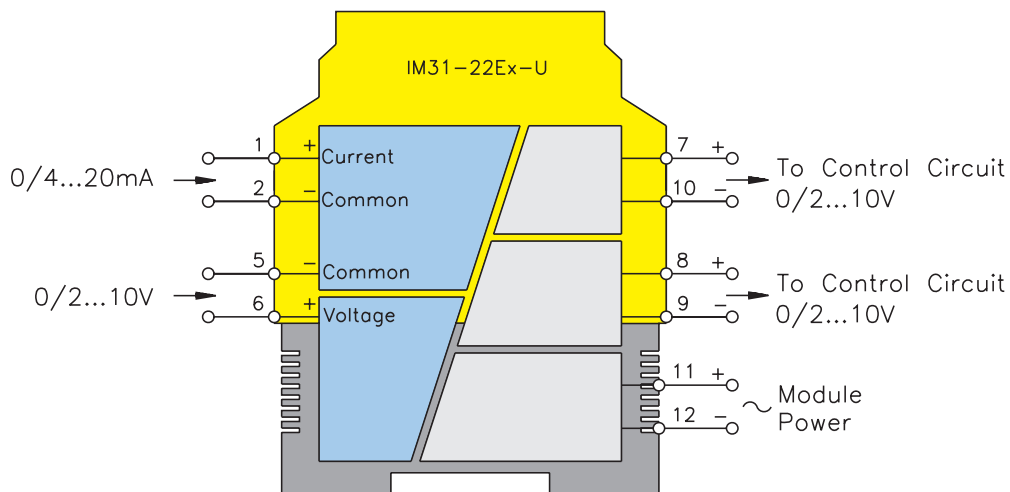
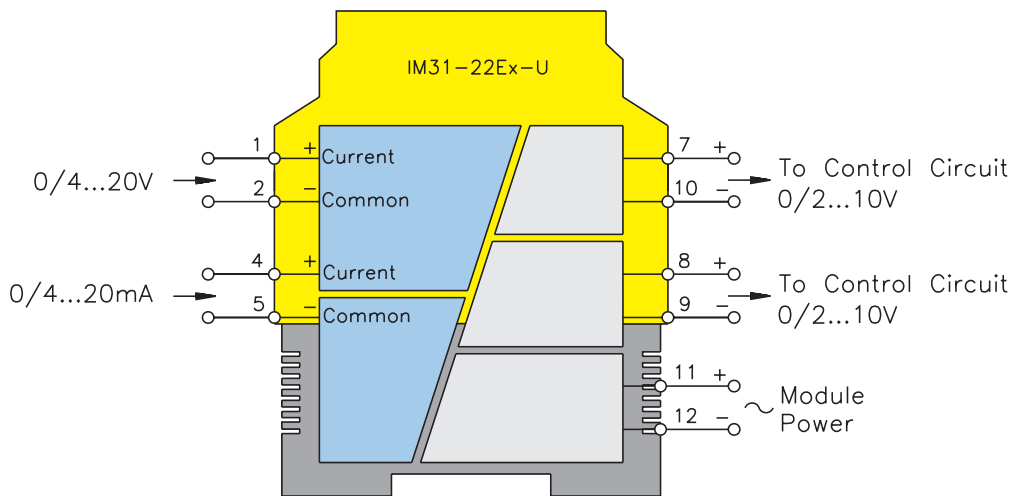

IM31-22Ex-U

Analog Data Transmitters

Pin #	Terminal Function
1	(+) 0/2-10 V Field Input
2	(-) 0/4-20 mA Field Input
2	(-) 0/2-10 V Field Input
3	(+) 0/2-10 V Field Input
4	(+) 0/4-20 mA Field Input
5	(-) 0/4-20 mA Field Input
5	(-) 0/2-10 V Field Input
6	(+) 0/2-10 V Field Input
7	(-) 0/2-10 V Non-Hazardous Area Output
8	(+) 0/2-10 V Non-Hazardous Area Output
9	(-) 0/2-10 V Non-Hazardous Area Output
10	(+) 0/2-10 V Non-Hazardous Area Output
11	Module Power (+) or AC
12	Module Power (-) or AC

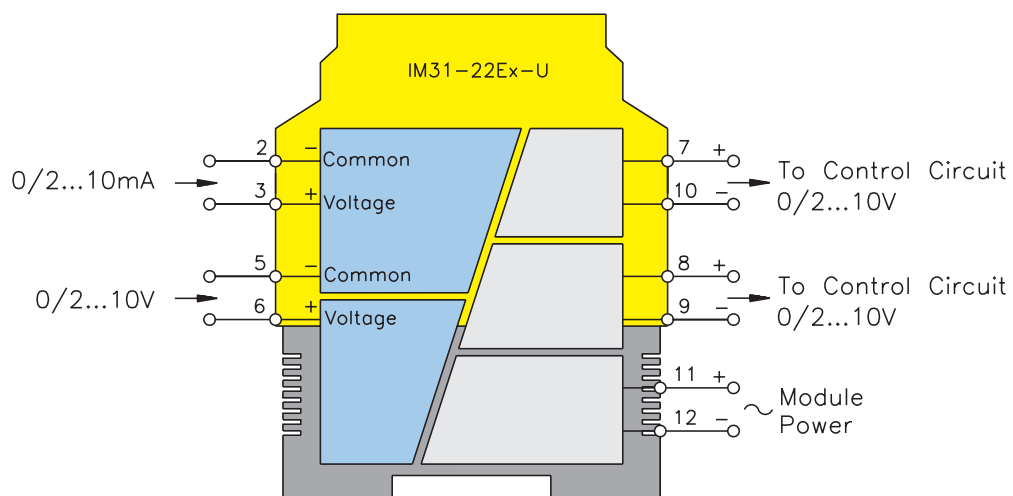
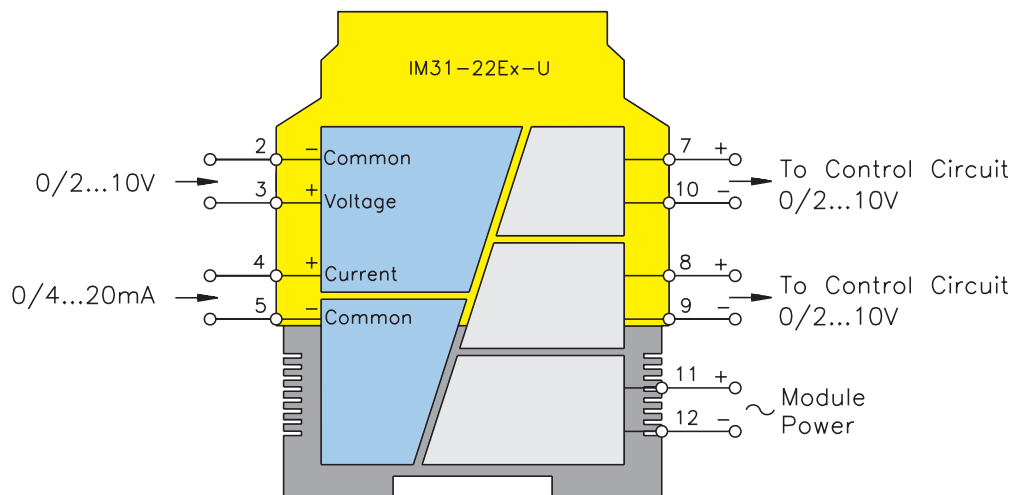

Notes:



Analog Input Repeaters/Supplies

The analog input repeaters/supplies interfaces in this section are designed to work with the vast majority of analog input field devices. Field devices can range from a simple 2-wire 4/20 mA transmitter to a 3-wire HART smart device requiring the interface to provide operating power and a bi-directional path for the digital HART information along with the 4/20 mA control signal. The analog input units will also accept a sourced signal from a separately powered field device, or other source generated by an "IS" device in a hazardous area. The unit can also be used to receive a sourced "IS" signal from a 4/20 mA driver with "IS" outputs in another non-hazardous area. The "IS" driver/"IS" receiver combination render the cable connections intrinsically safe thus allowing the driver/reciever cable to be used with other "IS" signals in multi-core cables or in an "IS" cable tray.

The analog input units versatility allows easy selection for most transmitter applications, thus reducing stock and inventory further simplifying the selection process. The control system can also be configured to provide alarm functions for certain states indicating the short or open-circuit conditions for the units.

Ease of installation is inherent when applying these devices.

Analog Input Repeaters/Supplies

Part Number Key

Part Number Keys are to assist in IDENTIFICATION ONLY. Consult Factory for catalog items not identified.

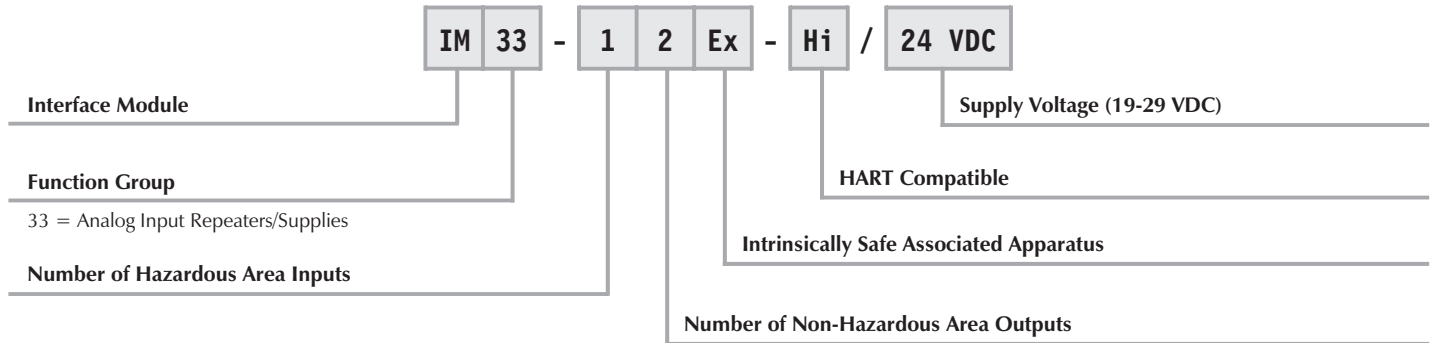

Extension Examples:

IM33-12Ex-Hi/24 VDC

- Interface Module
- Analog Input Repeaters/Supplies
- Single Channel Input
- Two Non-Hazardous Area Current Outputs
- Intrinsically Safe Associated Apparatus
- HART Compatible
- 24 VDC Supply Voltage

IM33-11Ex-Hi/24 VDC

Analog Input Repeaters/Supplies



Pin #	Terminal Function
1	(+) 2-wire or 3-wire Field Power
2	(+) 2-wire or 3-wire Field Power
3	(-) Field Power for 2,3 Wire Device
4	N/C
5	N/C
6	N/C
7	(+) 4/20 mA Non-Hazardous Area Output
8	N/C
9	N/C
10	(-) 4/20 mA Non-Hazardous Area Output
11	Module Power (+) or AC
12	Module Power (-) or AC

Functional Description:

This 1 channel intrinsically safe interface will power a 2 or 3-wire HART transmitter or a separately powered field device. It will retransmit the 0/20 mA or 4/20 mA signal from a hazardous area, and repeat the signal in the non-hazardous area as a 0/20 mA or 4/20 mA signal reflecting the hazardous area input. The device will also accept a sourced 0/20 mA or 4/20 mA signal from a separately powered field device and repeat this signal in the non-hazardous area. It will drive a non-hazardous area load of up to 500 Ω.

Due to the "1:1" transmission characteristic, open circuit or short circuit conditions can be indicated by a 0 mA or 22.5 mA reading indicating the condition for alarm implementation.

HART or conventional transmitters can be accommodated by this device with bi-directional communications of digital information with HART field devices.

Features:

- 1 channel HART or "IS" compatible Analog Input
- 2, 3 or 4-wire configurations for sinking or sourcing field devices
- Constant field voltage
- Short-circuit protected field circuit
- Over/under current indication of 0 or 22.5 mA
- SIL 2 rated

Electrical Parameters:

Inputs: Hazardous Area

Supply Voltage - (19-29 VDC)
 Input Resistance 250 Ω
 Operating Characteristics:
 Voltage 17 V @ 20 mA
 Current 0-22 mA
 Short-circuit Current (short-term) 60 mA (for 50 ms)

Outputs: Non-Hazardous Area

0/4-20 mA
 Load ≤500 Ω
 Open-circuit Indication . . . 0 mA
 Closed-circuit Indication . . . ≥22.5 mA

For entity parameters see control drawings on pages 86-91.

Analog Input Repeaters/Supplies IM33-11Ex-Hi/24 VDC

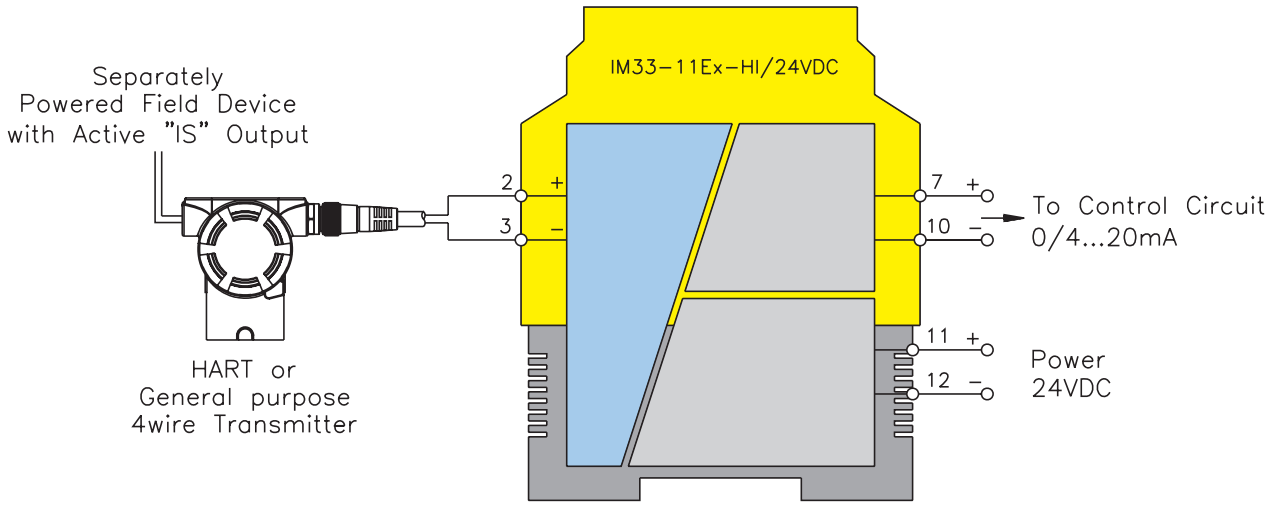
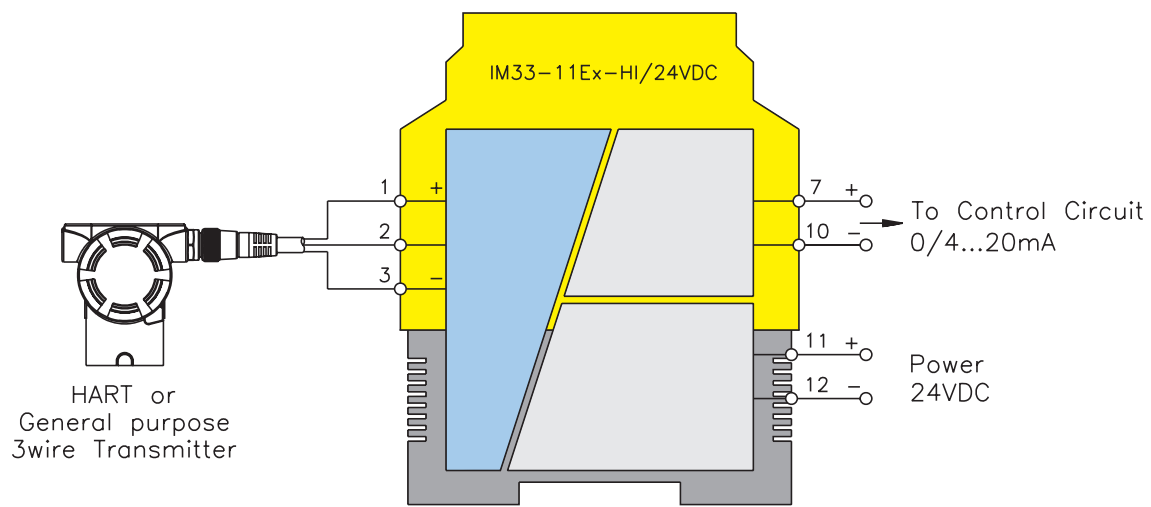
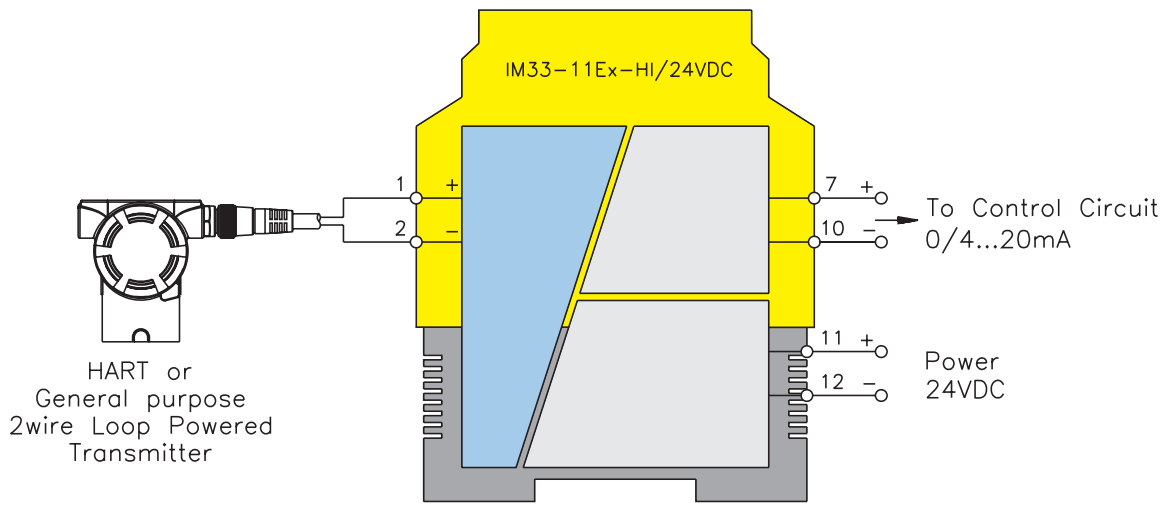

IM33-12Ex-Hi/24 VDC

Analog Input Repeaters/Supplies



Pin #	Terminal Function
1	(+) 2-wire or 3-wire Field Power
2	4/20 mA Input from Field Device
3	(-) Field Power for 2, 3-wire Device
4	N/C
5	N/C
6	N/C
7	(+) 4/20 mA Non-Hazardous Area Output
8	(+) 4/20 mA Non-Hazardous Area Output
9	(-) 4/20 mA Non-Hazardous Area Output
10	(-) 4/20 mA Non-Hazardous Area Output
11	Module Power (+) or AC
12	Module Power (-) or AC

Functional Description:

This 1 channel intrinsically safe interface will power a 2 or 3-wire HART transmitter or a separately powered field device and retransmit the 0/20 mA or 4/20 mA from a hazardous area and repeat the signal in the non-hazardous area as two 0/20 mA or 4/20 mA signals reflecting the hazardous area input. The device will also accept a sourced 0/20 mA or 4/20 mA signal from a separately powered field device and repeat this signal as two non-hazardous area signal. It will drive two separate non-hazardous area loads of up to 500 Ω each.

Due to the "1:1" transmission characteristic, open-circuit or short-circuit conditions can be indicated by a 0 mA or 22.5 mA reading indicating the condition for alarm implementation.

Features:

- 1 channel HART or "IS" compatible analog inputs
- 2, 3, or 4-wire configurations for sinking or sourcing field devices in any combination
- 2 independent 0/4-20 mA outputs reflecting a single hazardous area input
- Constant field voltage
- Short-circuit protected field circuits
- Over/under current indication of 0 or 22.5 mA
- SIL 2 rated

Electrical Parameters:

Inputs: Hazardous Area

Supply Voltage - (19-29 VDC)
 Input Resistance 250 Ω
 Operating Characteristics:
 Voltage. 17 V @ 20 mA
 Current 0-22 mA
 Short-circuit Current (short-term) 60 mA (for 50 ms)

Outputs: Non-Hazardous Area

0/4-20 mA
 Load ≤500 Ω
 Open-circuit Indication . . . 0 mA
 Closed-circuit Indication . . . ≥22.5 mA

For entity parameters see control drawings on pages 86-91.

Analog Input Repeaters/Supplies IM33-12Ex-Hi/24 VDC

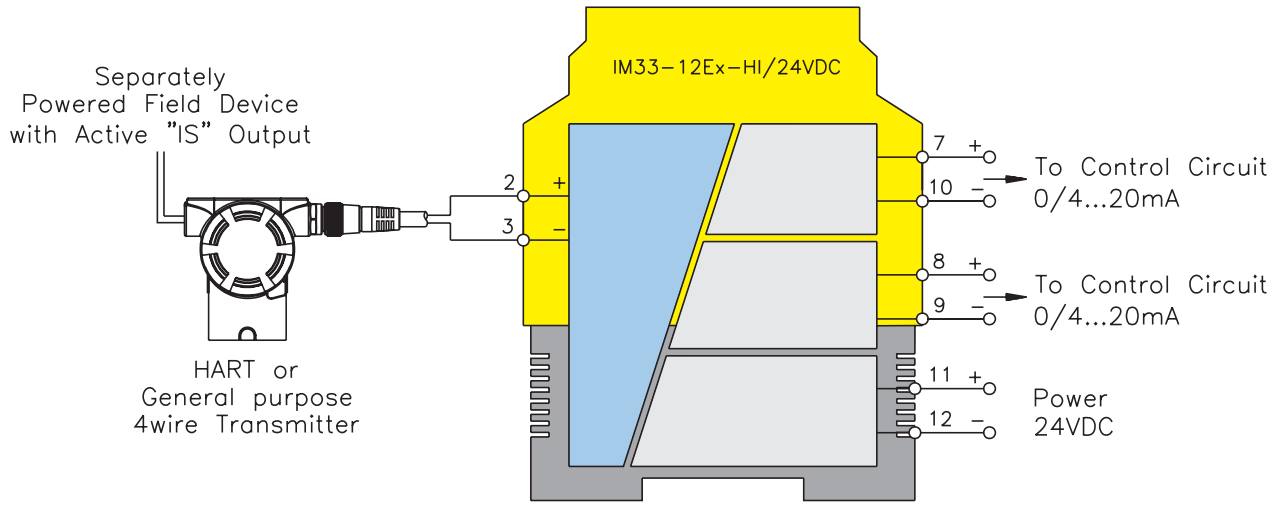
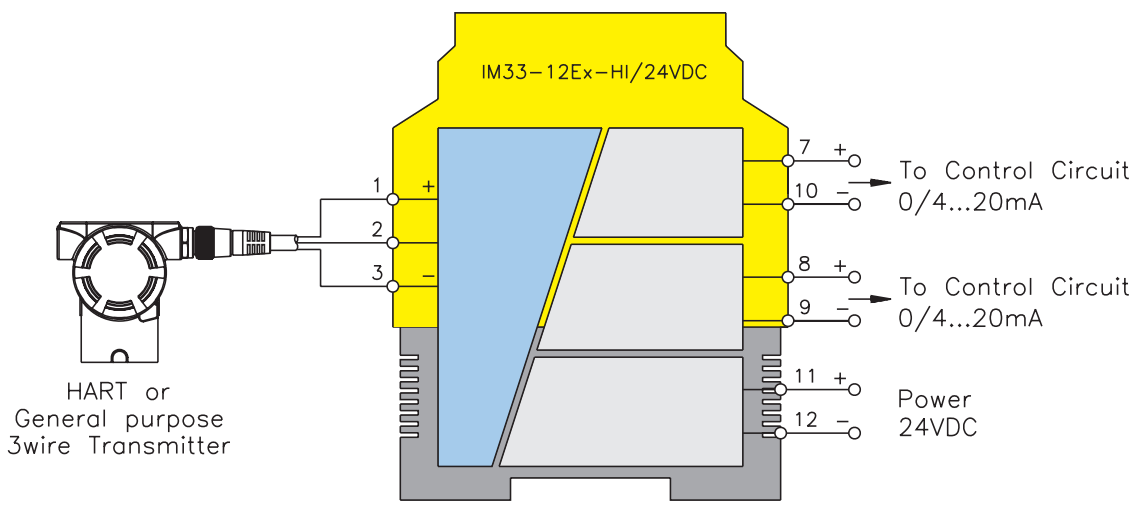
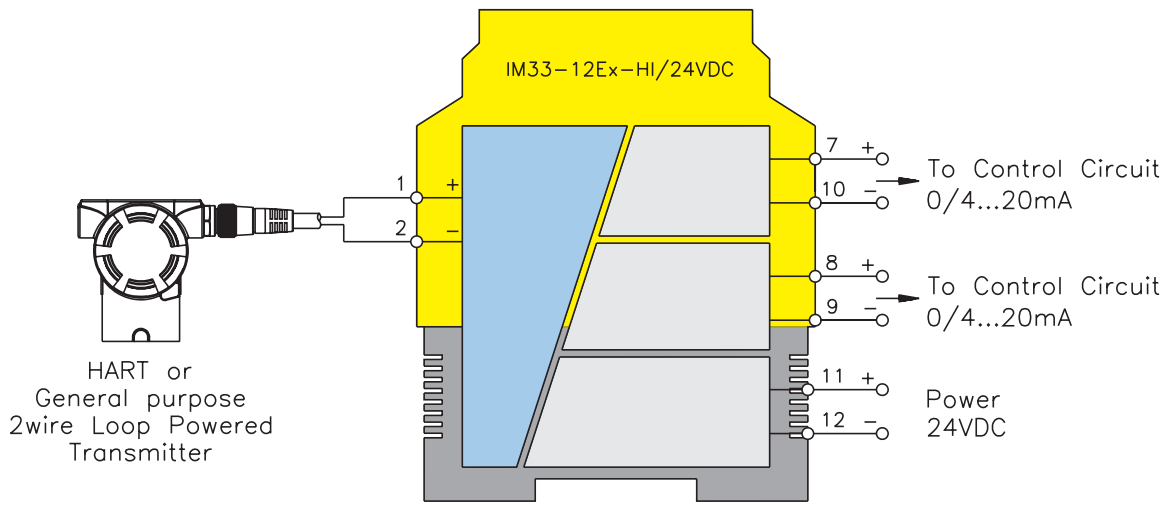

IM33-22Ex-Hi/24 VDC

Analog Input Repeaters/Supplies



Pin #	Terminal Function
1	(+) 2-wire or 3-wire Field Power
2	4/20 mA Input from Field Device
3	(-) Field Power for 2, 3-wire Device
4	(+) 2-wire or 3-wire Field Power
5	4/20 mA Input from Field Device
6	(-) Field Power for 2,3-wire Device
7	(+) 4/20 mA Non-Hazardous Area Output
8	(+) 4/20 mA Non-Hazardous Area Output
9	(-) 4/20 mA Non-Hazardous Area Output
10	(-) 4/20 mA Non-Hazardous Area Output
11	Module Power (+) or AC
12	Module Power (-) or AC

Functional Description:

This 2 channel intrinsically safe interface will power two separate 2 or 3-wire HART Transmitters or separately powered field devices or any combination of these devices and retransmit the 0/20 mA or 4/20 mA from a hazardous area and repeat the signal in the non-hazardous area as two separate 0/20 mA or 4/20 mA signals reflecting the hazardous area input. The device will also accept two separate sourced 0/20 mA or 4/20 mA signals from separately powered field devices and repeat these signals as two non-hazardous area signals. It will drive two separate non hazardous-area loads of up to 500 Ω each.

Due to the "1:1" transmission characteristic, open circuit or short-circuit conditions can be indicated by a 0 mA or 22.5 mA reading indicating the condition for alarm implementation.

HART or conventional "IS" transmitters can be accommodated by this device with bi-directional communications of digital information with HART field devices.

Features:

- 2 independent channel HART or "IS" compatible analog Inputs
- 2, 3, or 4-wire configurations for sinking or sourcing field devices in any combination
- Constant field voltage for each channel
- Short-circuit protected field circuits
- Over/under current indication of 0 or 22.5 mA
- SIL 2 rated

Electrical Parameters:

Inputs: Hazardous Area

Supply Voltage - (19-29 VDC)
 Input Resistance 250 Ω
 Operating Characteristics:
 Voltage. 17 V @ 20 mA
 Current 0-22 mA
 Short-circuit Current (short-term) 60 mA (for 50 ms)

Outputs: Non-Hazardous Area

0/4-20 mA
 Load ≤500 Ω
 Open-circuit Indication . . . 0 mA
 Closed-circuit Indication . . ≥22.5 mA

For entity parameters see control drawings on pages 86-91.

Analog Input Repeaters/Supplies IM33-22Ex-Hi/24 VDC

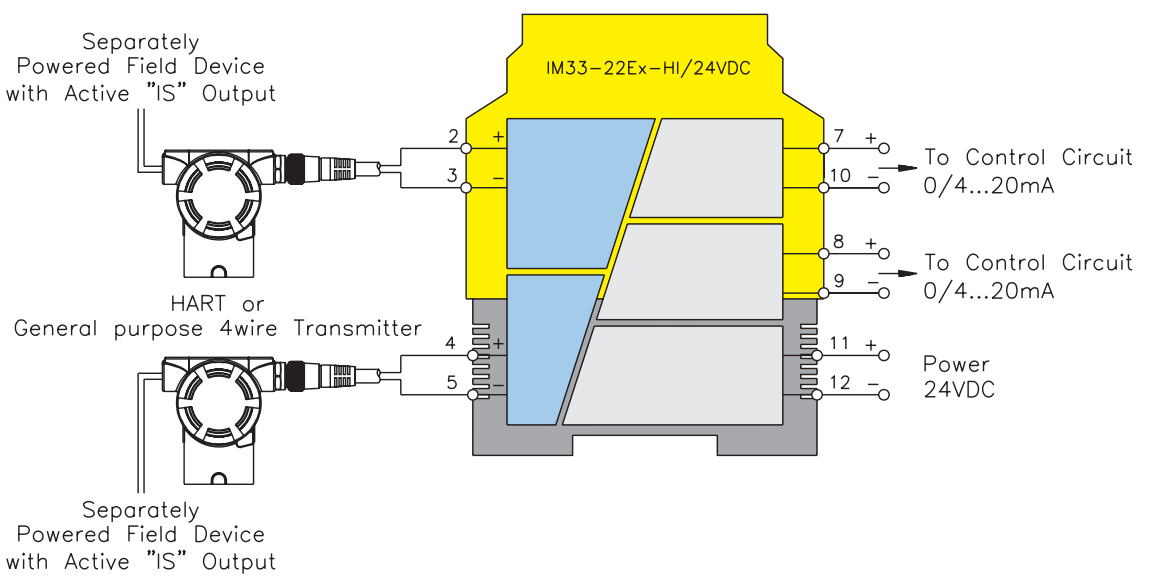
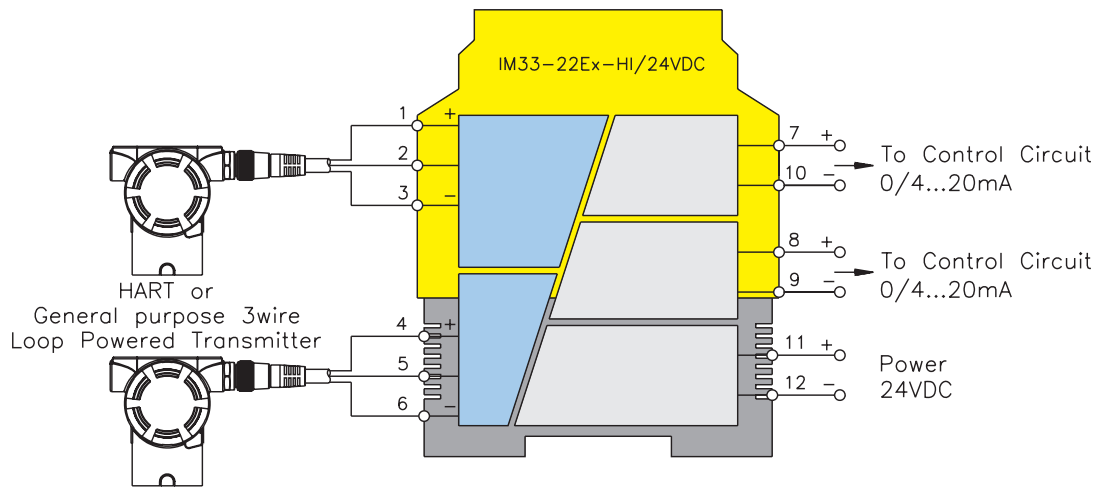
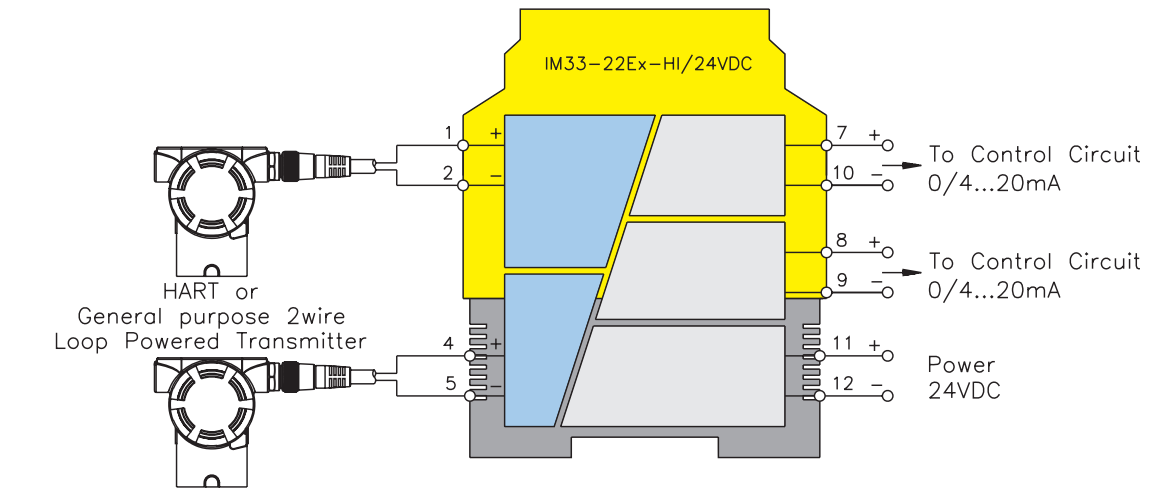

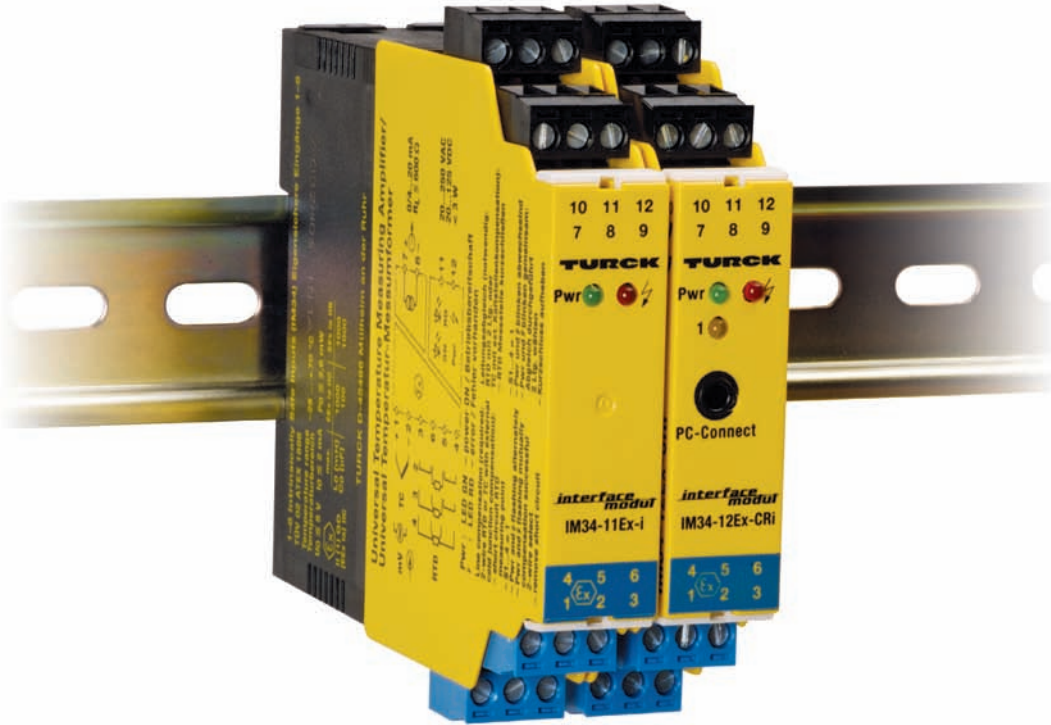

Temperature Converters

Temperature measurement is a very common application, even in hazardous areas. The IM34 temperature converting device provides advanced diagnostics, versatility and convenience in an easy-to-use device.

The IM34 will convert a 2, 3 or 4-wire RTD, mV signal, or T/C in a hazardous area, to an analog 4/20 mA signal in a non-hazardous area. This pushbutton or software (FDT/DTM, free shareware) configurable unit is simple to use and saves time and money on installations.

This diverse unit allows several different input types to be configured and used with common 4/20 mA analog input control cards. Elimination of separate RTD, T/C and mV input cards may consolidate inventory, as well as allow the use of off-the-shelf "Simple Apparatus" components in even the most explosive atmospheres; further reducing costs for installation and maintenance.

Temperature measurement in hazardous areas has never been easier, or as safe, than this.

Temperature Converters Part Number Key

Part Number Keys are to assist in IDENTIFICATION ONLY. Consult Factory for catalog items not identified.

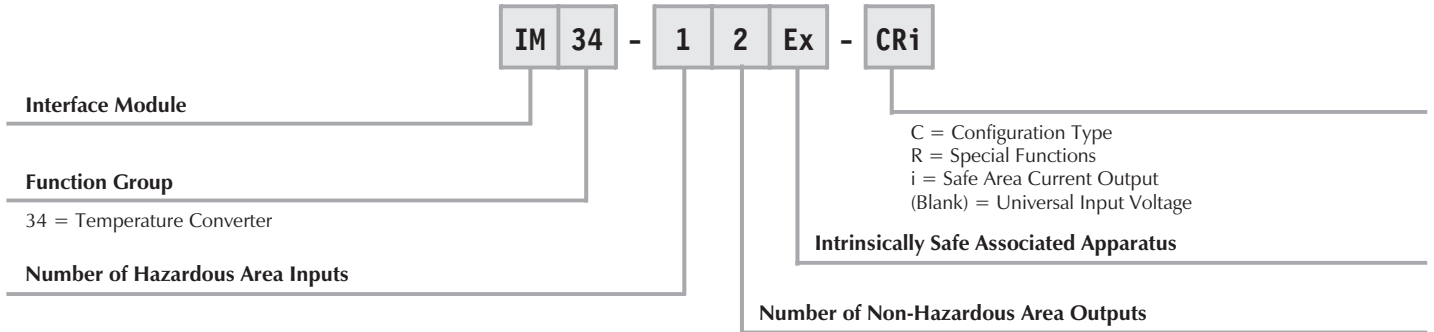

Extension Examples:

IM34-12Ex-CRi

- Interface Module
- Temperature Converter
- Single Channel Input
- Two Non-Hazardous Area Current Outputs
- Intrinsically Safe Associated Apparatus
- Computer or Remote Configuration
- Alarm Contacts
- Non-Hazardous Current Output
- Universal Voltage Input

IM34-11Ex-I

Temperature Converters



Functional Description:

This single channel device is designed to provide an analog 4/20 mA signal to a control system that is converted from an RTD, T/C, or mV signal in a hazardous area.

The measuring range and device functions are set via rotary switches or slide switches on the side of the device.

Features:

- 1 channel temperature input
- Accepts 2, 3, or 4-wire RTD's, T/C's or mV
- Switch configurable by user
- Temperature range adjustable
- Over/under current indication of 0 or 22 mA
- Internal or external CJC configurable

Electrical Parameters:

Inputs: Hazardous Area

Supply Voltage - (20-250 VAC or 20-125 VDC)
 2, 3 or 4-wire 100 Ω Ni or Pt RTD's
 Range -200°K to +800°K (Pt100), -60°K to +250°K (Ni100)
 T/C's B, E, J, K, N, R, S, T
 Low Voltage -160 mV to +160 mV
 Resistor current approx. 200 microamps

Outputs: Non-Hazardous Area

0/4-20 mA (Load 600 Ω max)
 Relay: 250 VAC/120 VDC, 2A
 500 VA/60 W 10Hz

For entity parameters see control drawings on pages 86-91.

Temperature Converters IM34-11Ex-i

Pin #	Terminal Function
1	(+) T/C or mV Input
2	(-) T/C or mV Input
3	3 or 4-wire RTD Connection
4	4-wire RTD Connection
5	2, 3 or 4-wire RTD Connection
6	2, 3 or 4-wire RTD Connection
7	(+) 0/4-20 mA Output
8	(-) 0/4-20 mA Output
9	No Connection
10	No Connection
11	Module Power (+) or AC
12	Module Power (-) or AC

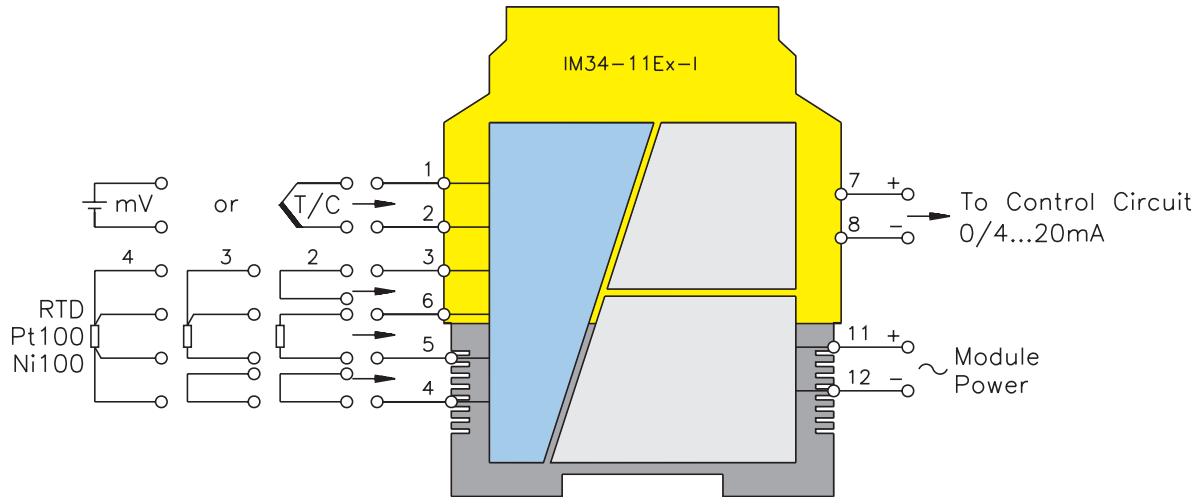

IM34-12Ex-Ri

Temperature Converters



Functional Description:

This single channel device is designed to provide an analog 4/20 mA signal to a control system that is converted from an RTD, T/C, or mV signal in a hazardous area.

This device has the added function of a relay output that can be used for under/over range conditions or to monitor a limit value.

The measuring range and device functions are set via rotary switches or slide switches on the side of the device.

Features:

- 1 channel temperature input
- Accepts 2, 3, or 4-wire RTD's, T/C's or mV
- Switch configurable by user
- Temperature range adjustable
- Configurable limit value relay output
- Over/under current indication of 0 or 22 mA
- Internal or external CJC configurable

Electrical Parameters:

Inputs: Hazardous Area

Supply Voltage - (20-250 VAC or 20-125 VDC)
 2, 3 or 4-wire 100 Ω Ni or Pt RTD's
 Range -200°K to +800°K (Pt100), -60°K to +250°K (Ni100)
 T/C's B, E, J, K, N, R, S, T
 Low Voltage -160 mV to +160 mV
 Resistor current approx. 200 microamps

Outputs: Non-Hazardous Area

0/4-20 mA (Load 600 Ω max)
 Relay: 250 VAC/120 VDC, 2A
 500 VA/60 W 10Hz

For entity parameters see control drawings on pages 86-91.

Temperature Converters IM34-12Ex-Ri

Pin #	Terminal Function
1	(+) T/C or mV Input
2	(-) T/C or mV Input
3	3 or 4-wire RTD Connection
4	4-wire RTD Connection
5	2, 3 or 4-wire RTD Connection
6	2, 3 or 4-wire RTD Connection
7	(+) 0/4-20 mA Output
8	(-) 0/4-20 mA Output
9	Alarm Contact
10	Alarm Contact
11	Module Power (+) or AC
12	Module Power (-) or AC

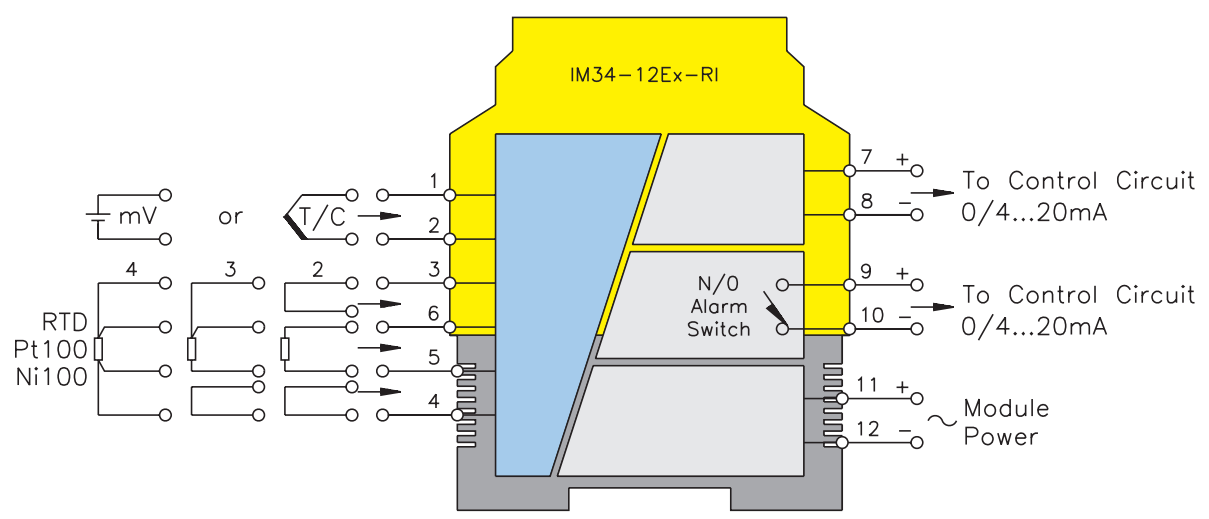

IM34-11Ex-Ci

Temperature Converters



Functional Description:

This single channel device is designed to provide an analog 4/20 mA signal to a control system that is converted from an RTD, T/C or mV signal in a hazardous area.

This device is software configurable using the PACTware software tool and a configuration cable that allows configuration to be achieved through your laptop or PC.

Features:

- 1 channel temperature input
- Accepts 2, 3 or 4-wire RTD's, T/C's or mV
- Software configurable by user via PC using PACTware with software tool "Device Type Manager" (DTM)
- Temperature range adjustable
- Over/under current indication of 0 or 22 mA
- Internal or external CJC configurable

Electrical Parameters:

Inputs: Hazardous Area

Supply Voltage - (20-250 VAC or 20-125 VDC)
 2, 3 or 4-wire 100 Ω Ni or Pt RTD's
 Range -200°K to +800°K (Pt100), -60°K to +250°K (Ni100)
 T/C's B, E, J, K, N, R, S, T
 Low Voltage -160 mV to +160 mV
 Resistor current approx. 200 microamps

Outputs: Non-Hazardous Area

0/4-20 mA (Load 600 Ω max)

For entity parameters see control drawings on pages 86-91.

Temperature Converters IM34-11Ex-Ci

Pin #	Terminal Function
1	(+) T/C or mV Input
2	(-) T/C or mV Input
3	3 or 4-wire RTD Connection
4	4-wire RTD Connection
5	2, 3 or 4-wire RTD Connection
6	2, 3 or 4-wire RTD Connection
7	(+) 0/4-20 mA Output
8	(-) 0/4-20 mA Output
9	No Connection
10	No Connection
11	Module Power (+) or AC
12	Module Power (-) or AC
Prog Port	Top of Unit to PC

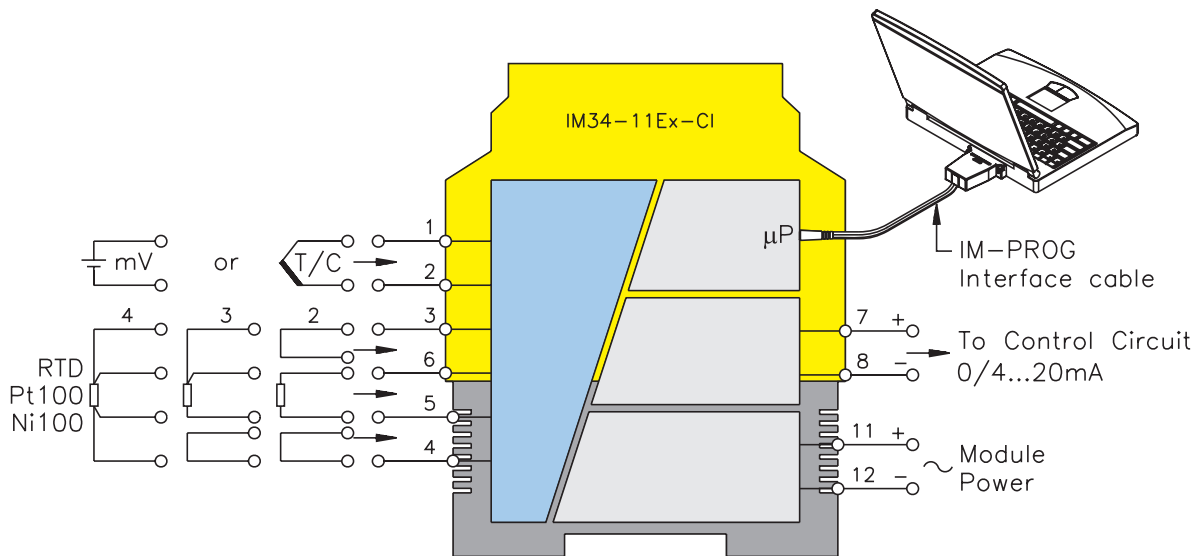

IM34-12Ex-CRi

Temperature Converters



Functional Description:

This single channel device is designed to provide an analog 4/20 mA signal to a control system that is converted from an RTD, T/C or mV signal in a hazardous area.

This device is software configurable using the PACTware software tool and a configuration cable that allows configuration to be achieved through your laptop or PC.

This device has the added function of a relay output that can be used for under/over range conditions or to monitor a limit value.

Features:

- 1 channel temperature input
- Accepts 2, 3 or 4-wire RTD's, T/C's or mV
- Software configurable by user via PC using PACTware with software tool "Device Type Manager" (DTM)
- Temperature range adjustable
- Configurable limit value relay output
- Over/under current indication of 0 or 22 mA
- Internal or external CJC configurable

Electrical Parameters:

Inputs: Hazardous Area

Supply Voltage - (20-250 VAC or 20-125 VDC)
 2, 3 or 4-wire 100 Ω Ni or Pt RTD's
 Range -200°K to +800°K (Pt100), -60°K to +250°K (Ni100)
 T/C's B, E, J, K, N, R, S, T
 Low Voltage -160 mV to +160 mV
 Resistor current approx. 200 microamps

Outputs: Non-Hazardous Area

0/4-20 mA (Load 600 Ω max)
 Relay: 250 VAC/120 VDC, 2A
 500 VA/60 W 10Hz

For entity parameters see control drawings on pages 86-91.

Temperature Converters

IM34-12Ex-CRi

Pin #	Terminal Function
1	(+) T/C or mV Input
2	(-) T/C or mV Input
3	3 or 4-wire RTD Connection
4	4-Wire RTD Connection
5	2, 3 or 4-wire RTD Connection
6	2, 3 or 4-wire RTD Connection
7	(+) 0/4-20 mA Output
8	(-) 0/4-20 mA Output
9	Alarm Contact
10	Alarm Contact
11	Module Power (+) or AC
12	Module Power (-) or AC
Prog Port	Top of Unit to PC

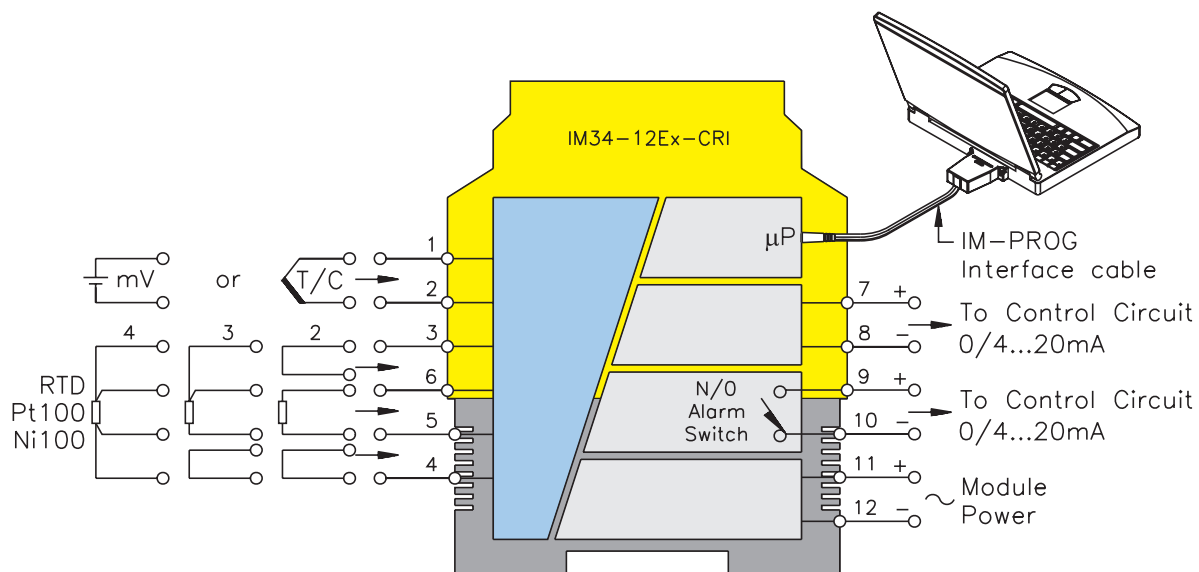

Temperature Converters

IM34-11Ex-i

IM34-12Ex-Ri

Short Description

- Inputs for Ni100 or Pt100 acc. to IEC 751, thermoelements acc. to IEC 584 and for low voltages (mV range)
- Intrinsically safe input circuit [EEx ia] IIC
- Area of application acc. to ATEX: II (1) GD
- Wire-break monitoring
- Short-circuit monitoring of Pt100 or Ni100 components
- Galvanic isolation between input and output circuits and supply
- Analogue current output 0/4-20 mA
- Limit value relay (IM34-12Ex-Ri only)
- Temperature linear conversion
- Device configuration on side of housing
- Housing with coded and removeable terminal blocks

Terminal Configuration

Intrinsically safe inputs at terminals 1-6

1, 2	Thermoelement and mV input
3-6	Ni100 or Pt100 input
7, 8	Analogue current output
9,10	Limit value relay (IM34-12Ex-Ri only)
11,12	Supply voltage connection 20-250 VAC/20-125 VDC, ≤3 W

Connection via flat screw terminals with self-lifting pressure plates, connection profile ≤1 x 2.5 mm², 2 x 1.5 mm² or 2 x 1.0 mm² with wire sleeves.

LED Indications

Pwr	green power on (1)
	red error (2)
1	yellow relay energised (3) (IM34-12Ex-Ri only)

Attention: Status indications, see table on page 64.

Adjustments

The device settings are accomplished with 4 rotary switches and 10 slide switches (IM34-12Ex-Ri: 7 rotary switches and 13 slide switches) located on the right side of the housing.

- **High Temperature Value T_H :** the upper temperature range value according to an output current of 20 mA is set with the two rotary switches (1, 2). Rotary switch 2 serves to set temperature values in increments of a hundred degrees celsius. Switch 1 serves to set the temperature in steps of ten degrees. Thus, the temperature values can be set in steps of 10 K. (Example for switch position: 53 ⇒ 530°C). If the slide switch S6 is in position 1, the temperature range is automatically increased by a 1000°C to 1000-1990°C. Add a 1000°C to the temperatue value adjusted with rotary switches 1 and 2. (Examples for switch position: 53 ⇒ 1530°C; 00 ⇒ 1000°C).
- **Low Temperature Value T_L :** the two rotary switches (3, 4) serve to set the temperature which accords to an output current of 0 or 4 mA (determined by slide switch S8). If slide switch S5 is in position 1, rotary switch number 4 is used to adjust the temperature in hundreds, while switch 3 adjusts the tens place. Adjustment takes place in a temperature range of 0 to +990°C in increments of 10 K (e.g. rotary switch setting 23 accords to a temperature of 230°C). If slide switch S5 is in position 0, rotary switch 4 adjusts the negative tens places and rotary switch 3 adjusts the ones. Adjustments are possible in a temperature range of -100 to -1°C in increments of 1 K. (Examples for rotary switch position: 23 ⇒ -23°C; 00 ⇒ -100 °C).
- **Switching Threshold for Relay**
(IM34-12Ex-Ri only)
Rotary switch 5 = hundred degree values
Rotary switch 6 = ten degree values
Rotary switch 7 = one degree values
S11 and S12 = 1: add 1000°C to the adjusted value. S11 = 0: the adjusted value is negative. The output mode is adjusted with S13.

IM34-11Ex-i

IM34-12Ex-Ri

Switch Position				Functions of slide switches S1-S4: The 4 switches serve to select the following functions:
S1	S2	S3	S4	
0	0	0	0	Thermoelement Type B (IEC 584)
0	0	0	1	Type E
0	0	1	0	Type J
0	0	1	1	Type K
0	1	0	0	Type N
0	1	0	1	Type R
0	1	1	0	Type S
0	1	1	1	Type T (IEC 584)
1	0	0	0	Type L (DIN 43710)
1	0	1	0	Voltage input: the input for thermoelements can be used for linear conversion of low voltages from -100 to +160 mV. In this case the rotary switches are used to adjust mV values while the slides switches operate with different range indications: S5 = 0: -100 to -1 mV or S5 = 1: 0 to +99 mV for the lower range; S6 = 0: 0 to +99 mV or S6 = 1: +100 to +160 mV for the upper range;
1	1	0	0	Pt100 or Ni100 components with 4-wire connection;
1	1	0	1	Pt100 or Ni100 components with 3-wire connection, observe bridge;
1	1	1	0	Pt100 or Ni100 components with 2-wire connection, observe bridge;
1	1	1	1	Line compensation: when using 2-wire connections, the line length resistance must be adjusted. Line compensation is also necessary when using thermo-elements with an external cold junction. For this it is necessary to short-circuit the measuring point and to select the code for line compensation as shown on the left. The Pwr and the $\frac{1}{2}$ LED flash alternately. Successful line compensation is indicated by mutual flashing of both LEDs. Please select a different function and remove the short-circuit.

Temperature Converters

IM34-11Ex-i

IM34-12Ex-Ri

Functions of slide switches **S5-S10** (IM34-12Ex-Ri: **S5-S13**):

The following functions can be selected with the switches:

- **S5** Lower range selection: selection of temperature range of low temp. value T_L
S5 = 0: -100 to -1°C
S5 = 1: 0 to +990°C
- **S6** Upper range selection: selection of temperature range of high temp. value T_H :
S6 = 0: 0 to +990°C
S6 = 1: +1000 to +1990°C
- **S7** output current during an error condition:
If an input circuit error is detected, the output current is as follows
S7 = 0: 0 mA
S7 = 1: >22 mA
- **S8** output current range:
S8 = 0: 0-20 mA
S8 = 1: 4-20 mA
- **S9** Reference point compensation: when using thermoelements, reference point compensation is carried out as follows:
 - **externally** via 2-wire Ni100 or Pt100 in S9 = 0 or
 - **internally**: S9 = 1

Mounting and Installation

The connected apparatus (Ni100/Pt100, thermoelements) must meet the requirements for use in explosion hazardous areas (EN60079-14). The device is suited for snap-on clamps for hat rail mounting (EN 50022) or for screw panel mounting. Devices **of the same type** may be mounted directly next to each other. It must be ensured that heat is conducted away from the device. Mounting and installation must be carried out in accordance with the applicable regulations. The removeable terminal blocks are coded and may only be plugged into the designated sockets. The coding system may not be altered or damaged. The device must be protected against dust, dirt, moisture and other environmental influences as well as against strong electro-magnetic emissions. It should also be protected against the risks of mechanical damaging, unauthorised access and incidental contact. All installations must be carried out observing the regulations of EMC protection.

With **internal** reference point compensation, care must be taken that heat is conducted away from the housing. Heat accumulation can corrupt measuring data.

- **S10** resistor type: indication of the connected resistor type:
S10 = 0: Pt100
S10 = 1: Ni100

With a voltage input or in case of thermoelement operation, the type of resistor does not have to be adjusted.

Referring to IM34-12Ex-Ri only:

- **S11, S12 and S13** Selection of switching threshold for limit value relay:
S11 = 0: -100 to -1°C
S11 = 1: >0°C

Only if S11 = 1
S12 = 0: 0 to +999°C
S12 = 1: +1000 to +1990°C
S13 Output performance of relay:
S13 = 0: relay energised, if measuring value > switching threshold
S13 = 1: relay energised, if measuring value < switching threshold

General information on use of devices with "IS" circuits

This device is equipped with circuits featuring protection type "intrinsic safety" for explosion protection per EN 50020 at terminals 1-6 which are marked in blue. The intrinsically safe circuits are approved by the authorised bodies for use in those countries to which the approval applies.

For **correct usage** in explosion hazardous areas it is required to **observe and follow the national regulations and directives strictly**. Following please find some guidelines referring to the framework directive of the European Union 94/9/EC (ATEX 100a).

This device is classified as an associated apparatus which is equipped with intrinsically safe and non-intrinsically safe circuits. Therefore it may not be installed in explosion hazardous areas. It is permitted to connect intrinsically safe equipment to the intrinsically safe connections of this device, provided the equipment complies with the regulations applying to use in the respective zone of the explosion hazardous area. When interconnecting devices within

IM34-11Ex-i

IM34-12Ex-Ri

such an assembly it is required to keep and provide a proof of intrinsic safety (EN 60079-14). Once that intrinsically safe circuits have been connected to the non-intrinsically safe circuit, it is not permitted to use the device subsequently as intrinsically safe equipment.

The governing regulations cover installation of intrinsically safe circuits, mounting to external connections, cable characteristics and cable installation. Cables and terminals with intrinsically safe circuits must be marked and separated from non-intrinsically safe circuits or feature appropriate isolation (EN 60079-14). It is required to observe the specified clearances between the intrinsically safe connections of this device and the earthed components and connections of other devices. The approval expires if the device is repaired, modified or opened by a person other than the manufacturer or an expert, unless the device-specific instruction manual explicitly permits such interventions.

Visible damages of the device's housing (e. g. black-brown discolouration due to heat accumulation, perforation or

deformation) indicate a serious error and the device must be turned off immediately. When using associated apparatus it is required to check the connected intrinsically safe equipment too. This inspection may only be carried out by an expert or the manufacturer. Operation of the device must conform to the data printed on the side of the housing.

Prior to initial set-up or after every alteration of the interconnection assembly it must be assured that the relevant regulations, directives and framework regulations are observed, that operation is errorfree and that all safety regulations are fulfilled. Mounting and connection of the device should only be carried out by qualified and trained staff familiar with the relevant national and international regulations of explosion protection.

The **most important data from the EC type examination certificate** are listed overleaf. All valid national and international approvals covering **TURCK** devices can be downloaded from our website www.turck.com. Further information can be provided on request.

Short Description

- Inputs for Ni100 or Pt100 acc. to IEC 751, thermo-elements acc. to IEC 584 and for low voltages (mV range)
- Intrinsically safe input circuit EEx ia
- Area of application acc. to ATEX: II (1) GD
- Wire-break monitoring
- Short-circuit monitoring only of Pt100 or Ni100 components
- Galvanic isolation between input and output circuits and supply
- Analogue current output 0/4-20 mA
- Voltage proof up to 4 kV (IM34-11Ex-Ci/K51 only)
- Fast temperature measurement from a temperature gradient of 200 μ V/s (IM34-11Ex-Ci/K60 only)
- Limit value relay (IM34-12Ex-CRi only)
- Temperature linear conversion
- Parameterisation via PC via programming adapter IM-PROG (to be ordered additionally – ident-no.: 6890422)
- Housing with coded and removeable terminal blocks
- Simulation of outputs

Terminal Configuration

Intrinsically safe inputs at terminals 1–6

1, 2	thermoelement and mV input
3 – 6	Ni100 or Pt100 input
7, 8	analogue current output (0/4-20 mA)
9, 10	Limit value relay (IM34-12Ex-CRi only)
11,12	supply voltage connection 20-250 VAC/20-125 VDC, <3 W

Connection via lifting cages with captive screws, connection profile:

$\leq 1 \times 2.5 \text{ mm}^2$, $2 \times 1.5 \text{ mm}^2$ or $2 \times 1 \text{ mm}^2$ with wire sleeves

LED Indications

Pwr	green power on
	red error
1	yellow relay energised (IM34-12Ex-CRi only)

Attention: Status Indications, see table on page 67.

Temperature Converters

IM34-11Ex-i

IM34-12Ex-Ri

Status Indications

LED Pwr	LED ζ	Only IM34-12Ex-CRi	Description
The values agree with the switch-on phase in % 0=0%, 10=10%, 50=50%, 100=100%		Output of error current, moreover relay is de-energized.	
100	0	–	Operation
100	10	•	Input error
10	100	•	Software error
0	100	•	Hardware error
100	50	•	Measuring span too short
100	50	–	Thermoelements/Measuring range/Switching threshold outside the operating range of the RTD or thermo-element
50	50	•	Line compensation (LEDs flashing alternately)
50	50	•	Line compensation finished
100	50	•	Line compensation not correct
50	0	–	Current output and limit value relay in simultaneous operation

IM34-11Ex-i

IM34-12Ex-Ri

Parameterisation and Adjustments

The IM34... is parameterised and adjusted via the Device Type Manager (see also "PACTware™ and devices DTM software installation"). The **TURCK** adapter IM-PROG is needed to establish the connection between the device and your PC.

For this it is necessary to connect the 3.5 mm connector to the measuring amplifier (PCCconnect) and the RS232 connector to the serial interface of your PC. The following settings are available as an entry or numerical setting via the DTM:

- **Mode**

Selection of the connection element: Pt/Ni100, thermo-element, mV input and selection of line compensation. The following settings depend on the selections made in the "Mode" menu:

- **Thermo-element**

Type selection: E, J, K, N, R, S, T, L, B

- **Connection Mode of Temperature Resistor**

2, 3 or 4-wire connection technology

- **Measuring Range**



The measuring range is composed of the lower and upper temperature value. After selecting the connecting type, the measuring range is indicated in the lower section of the DTM. These indications accord to the adjusted analogue output signal of 0/4-20 mA. The lower temperature depends on the type of thermoelement/temperature resistor and accords to an output signal of 0/4 mA. The upper limit temperature also depends on the type of thermo-element/temperature resistor. The adjusted upper limit temperature accords to an analogue output signal of 20 mA.

- **Output Signal**

The selection comprises 0-20 mA, 4-20 mA signals. The adjusted values correspond to the adjusted lower and upper limit temperatures.

- **Line Compensation**

In case of 2-wire connections, the resistor can be adapted to the connection cable. For this it is necessary to short the measuring point.

The LEDs Pwr and  flash alternately. If they start flashing mutually line compensation has been carried out. Continue by selecting another function and removing the short-circuit. If the LED  continues to flash, line compensation has not been accomplished successfully. Line compensation must also be carried out if thermo-elements with external cold junction are used.

- **Error Current**

Either 0 mA or >22 mA

- **Switching Threshold (IM34-12Ex-CRi only)**

Entry of a temperature value or a low voltage value at which the limit value relay is activated.

Mounting and Installation

The connected apparatus (Ni100/Pt100, thermo-elements) must meet the requirements for use in explosion hazardous areas (EN 60079-14). The device is suited for snap-on clamps for hat rail mounting (EN 50022) or for screw panel mounting. Devices **of the same type** may be mounted directly next to each other. It must be ensured that heat is conducted away from the device. Mounting and installation must be carried out in accordance with the applicable regulations. The operator is responsible for compliance with the regulations. The removeable terminal blocks are coded and may only be plugged into the designated sockets. The coding system may not be altered or damaged. The device must be protected against dust, dirt, moisture and other environmental influences as well as against strong electromagnetic emissions. It should also be protected against the risks of mechanical damaging, unauthorised access and incidental contact. All installations must be carried out observing the regulations of EMC protection.

Temperature Converters

IM34-11Ex-i

IM34-12Ex-Ri

Important information on use of devices with "IS" circuits

This device is equipped with circuits featuring protection type intrinsic safety for explosion protection per EN 50020 at terminals 1– 6 which are marked in blue. The intrinsically safe circuits are approved by the authorised bodies for use in those countries to which the approval applies.

For **correct usage** in explosion hazardous areas please **observe and follow the national regulations and directives strictly**.

Following please find some guidelines referring to the frame-work directive of the European Union 94/9/EC (ATEX 100a).

This device is classified as an associated apparatus which is equipped with intrinsically safe and nonintrinsically safe circuits. Therefore it may only be installed in the non-explosion hazardous area in dry clean and well monitored locations. It is permitted to connect intrinsically safe equipment to the intrinsically safe connections of this device.

All electrical equipment must comply with the regulations applying to use in the respective zone of the explosion hazardous area. If the intrinsically safe circuits lead into explosion hazardous areas subject to dust hazards, i.e. zone 20 or 21, it must be ensured that the devices which are to be connected to these circuits, meet the requirements of category 1D or 2D and feature an according approval.

When interconnecting devices within such an assembly it is required to keep and provide a proof of intrinsic safety (EN 60079-14). Once that intrinsically safe circuits have been connected to the non-intrinsically safe circuit, it is not permitted to use the device subsequently as intrinsically safe equipment. The governing regulations cover installation of intrinsically safe circuits, mounting to external connections, cable characteristics and cable

installation. Cables and terminals with intrinsically safe circuits must be marked and separated from nonintrinsically safe circuits or feature appropriate isolation (EN 60079-14). Please observe the specified clearances between the intrinsically safe connections of this device and the earthed components and connections of other devices.

The approval expires if the device is repaired, modified or opened by a person other than the manufacturer or an expert, unless the device-specific instruction manual explicitly permits such interventions.

Visible damages of the device's housing (e. g. blackbrown discolouration due to heat accumulation, perforation or deformation) indicate a serious error and the device must be turned off immediately. When using associated apparatus it is required to check the connected intrinsically safe equipment too. This inspection may only be carried out by an expert or the manufacturer.

Operation of the device must conform to the data printed on the side of the housing. Prior to initial set-up or after every alteration of the interconnection assembly it must be assured that the relevant regulations, directives and framework conditions are observed, that operation is error-free and that all safety regulations are fulfilled. Mounting and connection of the device may only be carried out by qualified and trained staff familiar with the relevant national and international regulations of explosion protection.

The **most important data from the EC type examination certificate** are listed overleaf. All valid national and international approvals covering **TURCK** devices are obtainable via the Internet (www.turck.com). Further information on explosion protection is available on request.

PACTware™ and Devices DTM Software Installation

You will require the following software components on your computer for the installation of PACTware:

- **PACTware software for parameterising of interface modules and excom®**
- **DTM**

These software components are available on the Internet at www.turck.com as a free-of-charge download.

- Select the homepage www.turck.com → Download → Software.

Your PC then requests the name of a directory at which it should save the files on the harddrive of your computer. The files are self-extracting archives, ZIP files, which extract independently when accessed.

- Simply double click on the ZIP archive to extract the files.
- You commence extraction of the file when you click on "Extract".

The "TURCK_FILES" directory is created on the current drive (e.g. C:\). Extract both file archives: (PACTware and DTM) before you commence with the actual software installation.

1. Installation of PACTware

Now start the installation of PACTware on your computer.

- Start Windows Explorer and change over to the "TURCK_FILES\PACTware...SetupTurck\PACTware" directory.
- Start the "setup.exe" file located there.

Follow the self-explanatory instructions displayed by the installation program and complete the installation.

2. Installation of the HART® Communication Driver

After the installation of PACTware has been successfully completed, the HART communication driver must now be installed.

Start the "setup.exe" file located at "TURCK_FILES...Dtms\Hart"

Follow the self-explanatory instructions displayed by the installation program and complete the installation.

3. Installing of the Devices DTM

After the installation of the HART communication driver been successfully completed, the devices DTM must be installed. A directory has been created to reflect the DTM which you have

downloaded. The name commences with the first 4 or 5 letters of the device type which you have selected.

- Start for example "setup.exe" in the "TURCK_FILES\IM34...Setup..." directory in order to install the devices DTM for the IM34.

Configuration of PACTware

Please restart your PC after installation in order to update the Windows registry. Then open PACTware and carry out configuration:

Make the following entries:

- User: "Administrator"
 - Password: "manager"
- Prior to parameterising a device, a project has to be created. For this, please select the device catalogue from the "View" menu or the < F3 > key. A new window with the name "Device catalogue" will open. This window contains all available "Device Type Managers - DTMs". Should a required DTM not be listed, please click on the button "Re-initialize the device catalogue"
- First add the HART protocol driver from the company Codewrights GmbH
 - Then add the DTMs from **TURCK**

Parameter entries for HART protocol driver parameters:

(Open the window by a double click):

- Communication-Interface:
"HART Multiplexer"
- Select serial interface
- Baud rate: "9600"

Possible error sources:

- RS232 port not addressable or being used by another application, Remedy: use different port or exit the application causing problems
- RS232 line too long (max. line length approx. 10 m), Remedy: shorten line

After successful installation and configuration it is now possible to communicate with the IM34....



Analog Output Isolators

Analog output isolators are for use with conventional 4/20 mA or HART smart "IS" devices are available in 1 and 2 channel versions. These devices are designed to provide a convenient way to transfer 4/20 mA signals, generated in a non-hazardous area, to a hazardous area intrinsically safe device, such as a valve positioner or I/P device.

HART capabilities allow bi-directional communications for HART devices if this function is being utilized. The same devices are also applicable for non-HART smart devices.

One device can be used for all applications of this type, which makes applying these devices simple. Stocking spares only requires one type of unit adding to the convenience.

Analog Output Isolators

Part Number Key

Part Number Keys are to assist in IDENTIFICATION ONLY. Consult Factory for catalog items not identified.

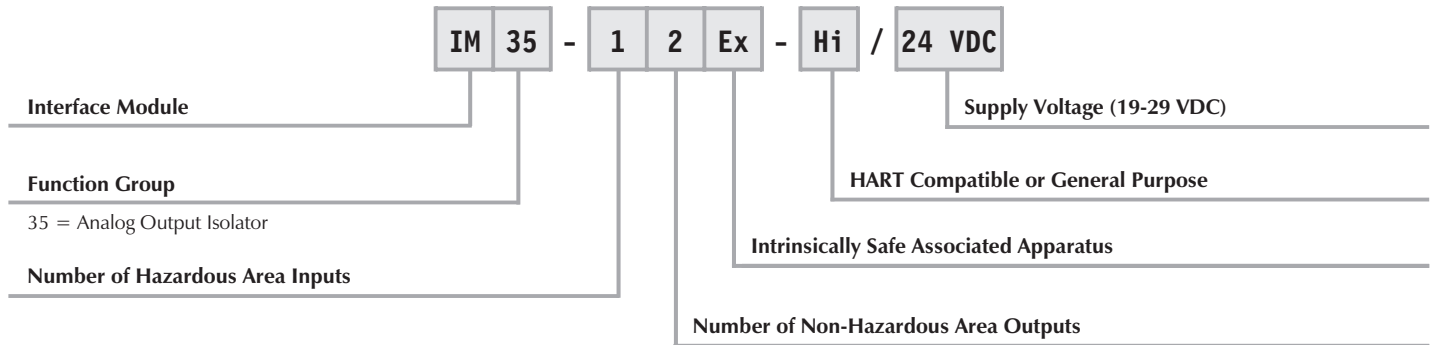

Extension Examples:

IM35-11Ex-Hi/24 VDC

- Interface Module
- Analog Output Isolator
- Single Channel Input
- One Non-Hazardous Area Current Output
- Intrinsically Safe Associated Apparatus
- HART Compatible
- 24 VDC Supply Voltage

IM35-11Ex-Hi/24 VDC

Analog Output Isolators

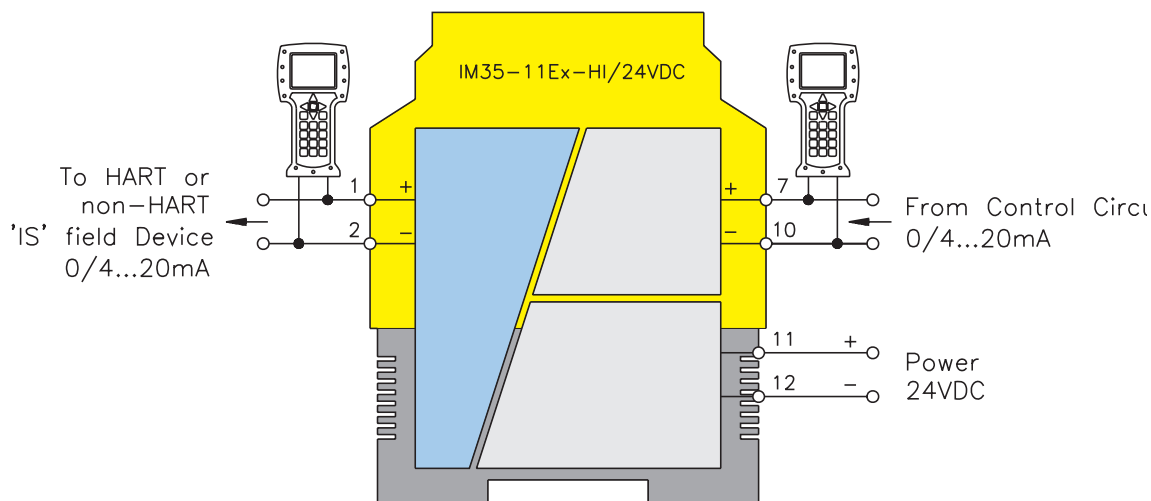

Functional Description:

This single channel device will allow a controller in a non-hazardous area to provide a 1:1 transfer of a 0/4-20 mA signal to a device in a hazardous area. Valve controllers or I/P devices that are intrinsically safe, as well as signals that are "IS" originating from another non-hazardous area, may be accommodated. Bi-directional HART communications capability is also incorporated.

Features:

- 1 channel 0/4-20 mA current driver
- HART or non-HART compatible
- Allows bi-directional HART communications
- Facilities for non-hazardous area HART monitoring
- Linearity of less than 0.1%
- Temperature drift less than 0.01% /K

Electrical Parameters:

Inputs: Hazardous Area

Supply Voltage (19-29 VDC)

0-20 mA

24 mA can be transferred max load of 430 Ω

Input Resistance 110 Ω

Outputs: Non-Hazardous Area

0/4-20 mA (Load 600 Ω max.)

Relay: 250 VAC/120 VDC, 2A

500 VA/60 W 10Hz

For entity parameters see control drawings on pages 86-91.

Analog Output Isolators

IM35-11Ex-Hi/24 VDC

Pin #	Terminal Function
1	(+) 0/4-20 mA Field Output
2	(-) 0/4-20 mA Field Output
3	No Connection
4	No Connection
5	No Connection
6	No Connection
7	(+) 0/4-20 mA Non-Hazardous Area Input
8	No Connection
9	No Connection
10	(-) 0/4-20 mA Non-Hazardous Area Input
11	Module Power (+)
12	Module Power (-)

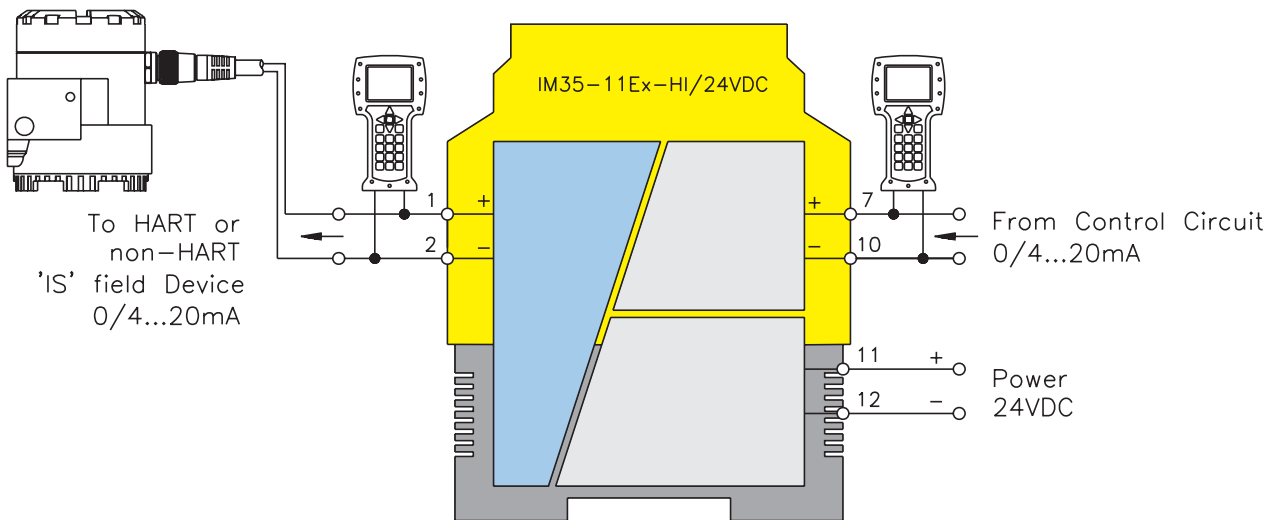

IM35-22Ex-Hi/24 VDC

Analog Output Isolators

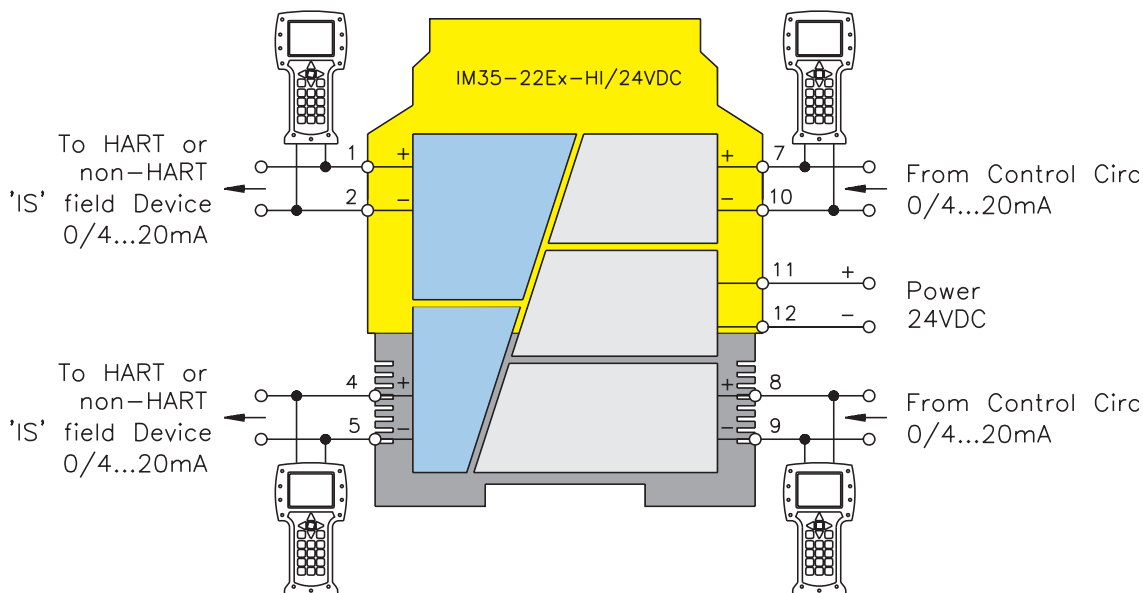

Functional Description:

This dual channel device will allow a controller in a non-hazardous area to provide a 1:1 transfer of 2 separate 0/4-20 mA signals to two separate devices in the hazardous area. Valve controllers or I/P devices that are intrinsically safe, as well as signals that are "IS" originating from another non-hazardous area, or any combination of these signals, may be accommodated. Bi-directional HART communications capability is also incorporated for both channels.

Features:

- 2 channel 0/4-20 mA current driver
- HART or non-HART compatible
- Allows bi-directional HART communications
- Facilities for non-hazardous area HART monitoring
- Linearity of less than 0.1%
- Temperature drift less than 0.01% /K

Electrical Parameters:

Inputs: Hazardous Area

Supply Voltage (19-29 VDC)

0-20 mA

24 mA can be transferred max load of 430 Ω

Input Resistance 110 Ω

Outputs: Non-Hazardous Area

0/4-20 mA(Load 600 Ω max)

24 mA with a max load of 430 Ω

Load is 600 Ω max

For entity parameters see control drawings on pages 86-91.

Analog Output Isolators

IM35-22Ex-Hi/24 VDC

Pin #	Terminal Function
1	(+) 0/4-20 mA Field Output
2	(-) 0/4-20 mA Field Output
3	No Connection
4	(+) 0/4-20 mA Field Output
5	(-) 0/4-20 mA Field Output
6	No Connection
7	(+) 0/4-20 mA Non-Hazardous Area Input
8	(+) 0/4-20 mA Non-Hazardous Area Input
9	(-) 0/4-20 mA Non-Hazardous Area Input
10	(-) 0/4-20 mA Non-Hazardous Area Input
11	Module Power (+)
12	Module Power (-)

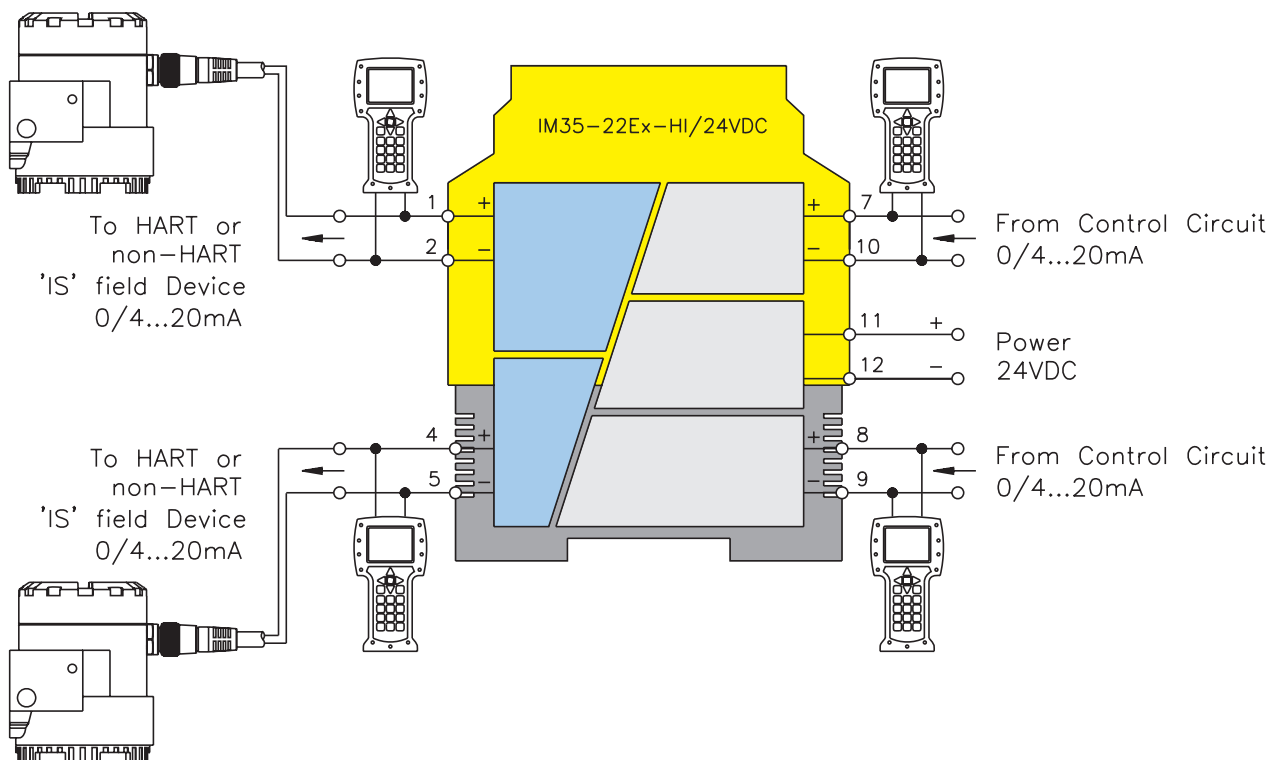



Solenoid Driver/Discrete Output Isolators

These loop powered "IS" interface devices provide power for "IS" solenoids in a hazardous area to be actuated from a controller in the non-hazardous area.

The IM72 solenoid drivers are uniquely designed devices that allow them to drive the vast majority of "IS" solenoids available in today's marketplace with a single type of interface device. Gone are the days when a wide variety of isolators were available to drive specific solenoids with specific requirements. A single device will now allow you to use a single model for most applications, eliminating the need to do complicated and tedious calculations.

The design of these 1 and 2 channel devices make it extremely simple to choose the appropriate interface. Either choose a 1 channel or 2 channel interface, that's all there is to it. Stock can be significantly reduced, and installation and maintenance made easier. With a single unit for most applications, the IM72 makes choosing the appropriate interface as easy as it gets.

Solenoid Driver/Discrete Output Isolators

Part Number Key

Part Number Keys are to assist in IDENTIFICATION ONLY. Consult Factory for catalog items not identified.

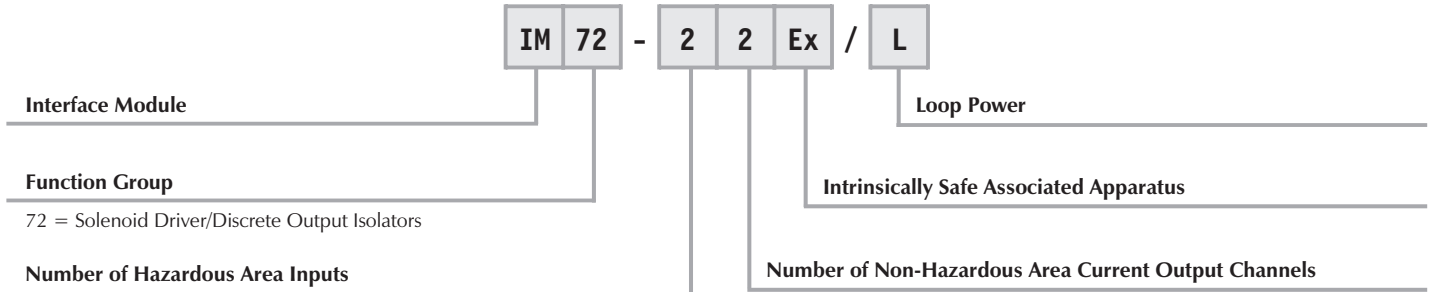

Extension Examples:

IM72-22Ex/L

Interface Module
Solenoid Driver/Discrete Output Isolators
Two Input Channels
Two Non-Hazardous Area Current Outputs
Intrinsically Safe Associated Apparatus
Looped Power

IM72-11Ex/L

Solenoid Driver/Discrete Output Isolators

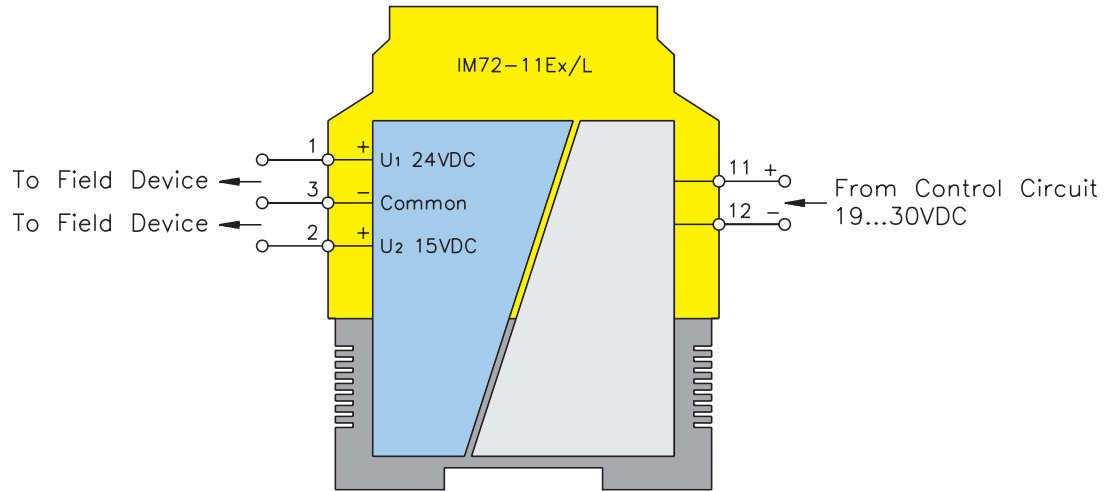

Functional Description:

This single channel device is designed to drive the vast majority of intrinsically safe solenoids available, as well as "IS" displays and other field devices that may require a separate "IS" power source. The unique design allows different configurations to be implemented depending on the specific field device being used.

Loop power is applied from a non-hazardous area source directly to the non-hazardous area inputs eliminating the requirement for additional power supply connections.

Features:

- 1 channel solenoid driver or "IS" supply
- Loop powered
- 2 output levels
- Switching frequency up to 500 Hz

Electrical Parameters:

Inputs: Hazardous Area

Supply (Loop Power)

- Signal "OFF" <5 V
- Signal "ON" 19-30 VDC
- Switch-on delay <400 μ

Outputs: Non-Hazardous Area

In accordance with Output Curve:

- U1=24 V (Pins 1 & 3) . . . U2=15 V (Pins 2 & 3)
- I1= 45 mA (Pins 1 & 3). . . I2=45 mA (Pins 2 & 3)
- Switching Frequency <500 Hz

For entity parameters see control drawings on pages 86-91.

Solenoid Driver/Discrete Output Isolators IM72-11Ex/L

Pin #	Terminal Function
1	U1 Field Output
2	U2 Field Output
3	Common Field Output
4	No Connection
5	No Connection
6	No Connection
7	No Connection
8	No Connection
9	No Connection
10	No Connection
11	(+) Non-Hazardous Area Input
12	(-) Non-Hazardous Area Input

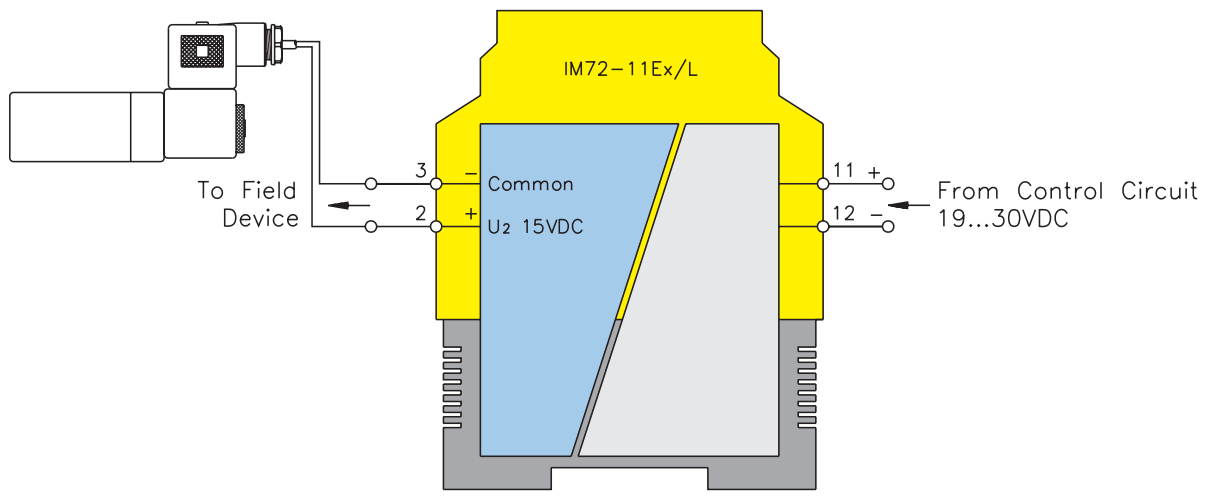
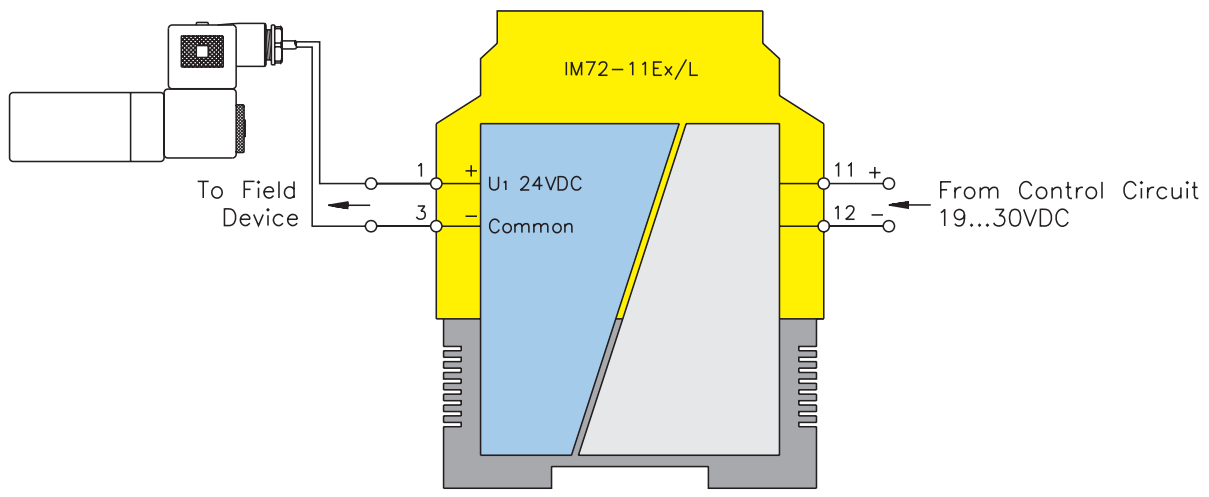

IM72-22Ex/L

Solenoid Driver/Discrete Output Isolators

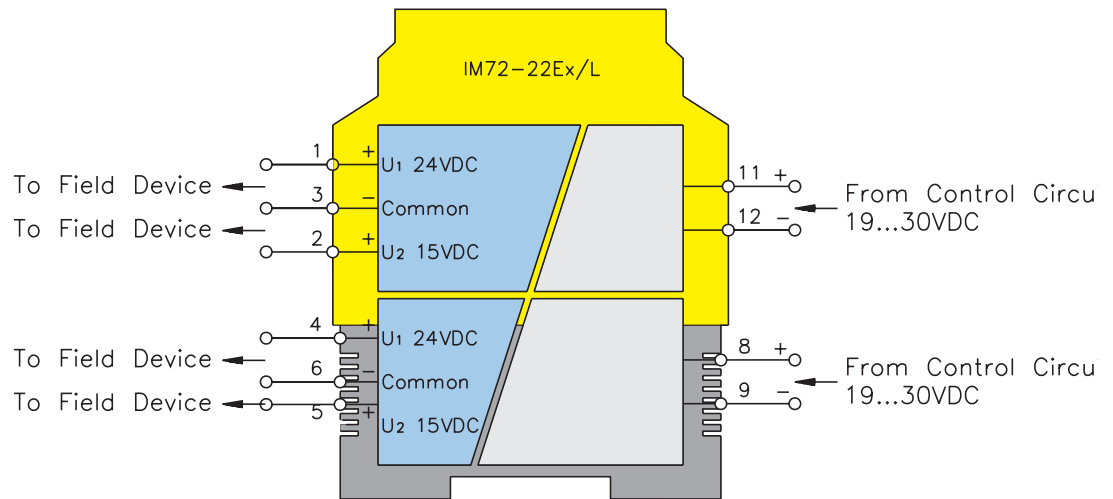

Functional Description:

This dual channel device is designed to drive 2 separate intrinsically safe solenoids, "IS" displays or other field devices that may require a separate "IS" power source, or any combination of these devices. The unique design allows different configurations to be implemented depending on the specific field device or devices being applied.

Loop power is applied from a non-hazardous area source directly to the non-hazardous area inputs of each channel eliminating the requirement for additional power supply connections.

Features:

- 2 channel solenoid driver or "IS" supply
- 2 isolated loop powered circuits
- 2 output levels per channel
- Switching frequency up to 500 Hz

Electrical Parameters:

Inputs: Hazardous Area

Supply (Loop Power)

- Signal "OFF" <5 V
- Signal "ON" 19-30 VDC
- Switch-on delay <400 μ

Outputs: Non-Hazardous Area

In accordance with Output Curve:

- U1=24 V (Pins 1 & 3, 4 & 6)
- U2=15 V (Pins 2 & 3, 5 & 6)
- I1= 45 mA (Pins 1 & 3, 4 & 6)
- I2=45 mA (Pins 2 & 3, 5 & 6)
- Switching Frequency <500 Hz

For entity parameters see control drawings on pages 86-91.

Solenoid Driver/Discrete Output Isolators

IM72-22Ex/L

Pin #	Terminal Function
1	U1 Field Output
2	U2 Field Output
3	Common Field Output
4	U1 Field Output
5	U2 Field Output
6	Common Field Output
7	No Connection
8	(+) Non-Hazardous Area Input
9	(-) Non-Hazardous Area Input
10	No Connection
11	(+) Non-Hazardous Area Input
12	(-) Non-Hazardous Area Input

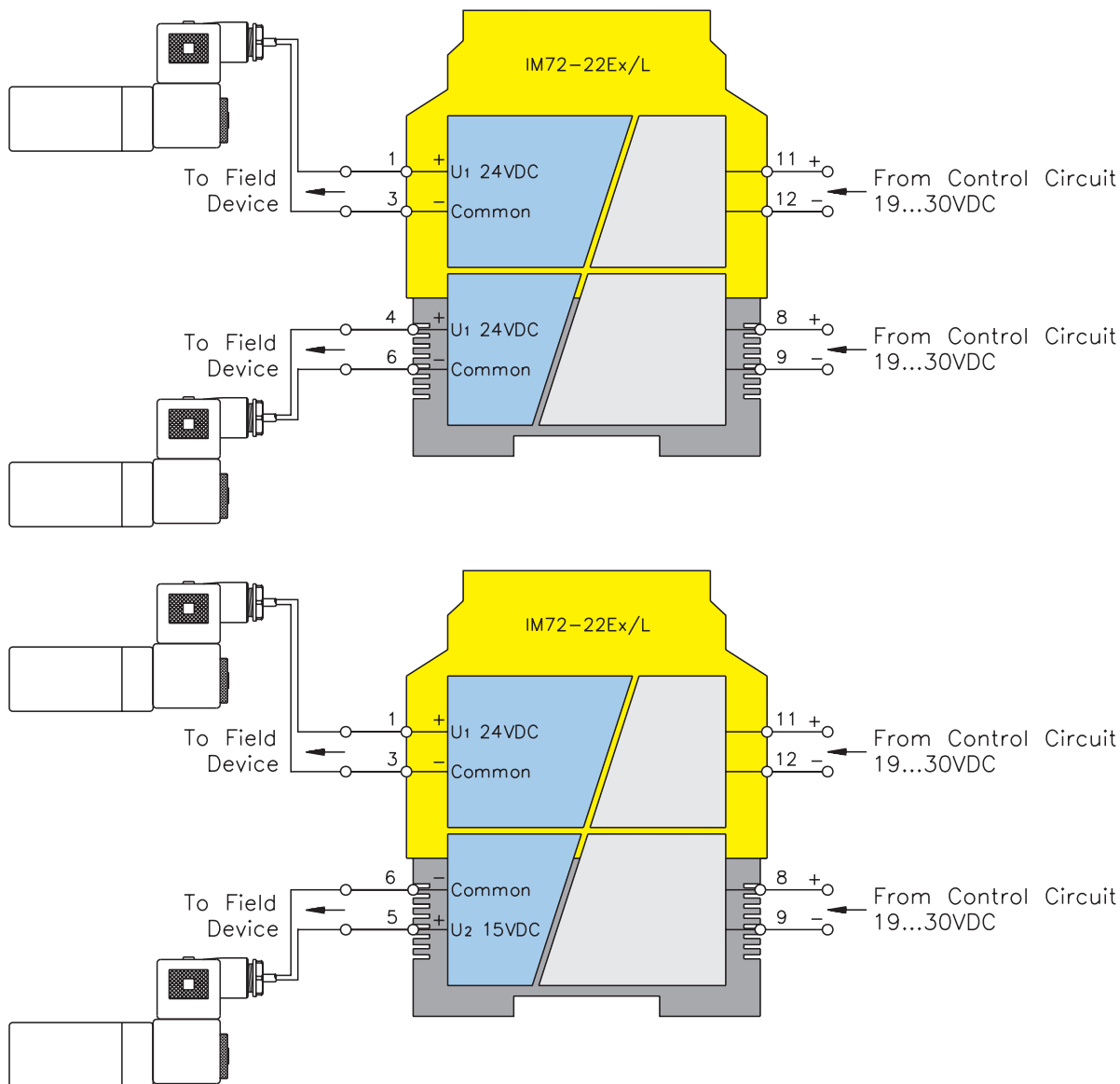

IM72-22Ex/L

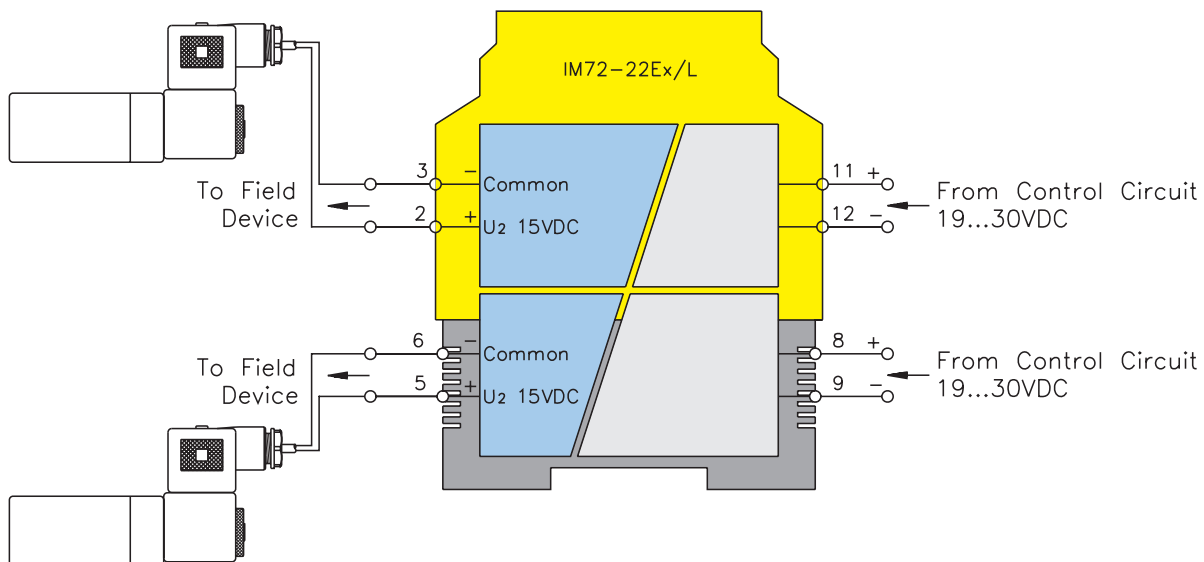
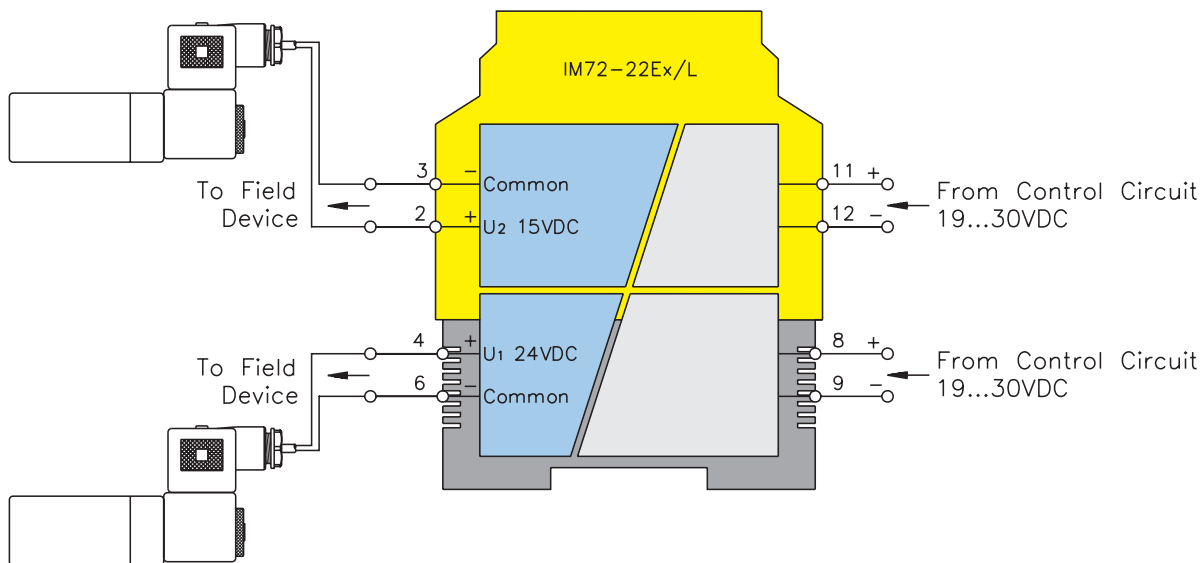

Solenoid Driver/Discrete Output Isolators

Pin #	Terminal Function
1	U1 Field Output
2	U2 Field Output
3	Common Field Output
4	U1 Field Output
5	U2 Field Output
6	Common Field Output
7	No Connection
8	(+) Non-Hazardous Area Input
9	(-) Non-Hazardous Area Input
10	No Connection
11	(+) Non-Hazardous Area Input
12	(-) Non-Hazardous Area Input



Notes:

Approvals

Part Number	IECEX Approval Number 	ATEX Approval Number 
	http://domino.iec.ch/IECEX/IECEXWeb.nsf	www.turck.com/IMATEX
IM1-121EX-R	IECEX TUN 06.0006X	PTB 00 ATEX 2033
IM1-121EX-T	IECEX TUN 06.0006X	PTB 00 ATEX 2033
IM1-12EX-MT	IECEX TUN 06.0006X	PTB 00 ATEX 2033
IM1-12EX-R	IECEX TUN 06.0006X	PTB 00 ATEX 2033
IM1-12EX-T	IECEX TUN 06.0006X	PTB 00 ATEX 2033
IM1-22EX-MT	IECEX TUN 06.0006X	PTB 00 ATEX 2033
IM1-22EX-R	IECEX TUN 06.0006X	PTB 00 ATEX 2033
IM1-22EX-T	IECEX TUN 06.0006X	PTB 00 ATEX 2033
IM1-451EX-R	IECEX TUN 06.0007X	PTB 00 ATEX 2033
IM1-451EX-T	IECEX TUN 06.0007X	PTB 00 ATEX 2033
IM12-22EX-R	IECEX TUN 06.0006X	PTB 00 ATEX 2033
IM31-11EX-I	IECEX TUN 06.0006X	TÜV 04 ATEX 2679
IM31-11EX-U	IECEX TUN 06.0006X	TÜV 04 ATEX 2679
IM31-12EX-I	IECEX TUN 06.0006X	TÜV 04 ATEX 2679
IM31-22EX-I	IECEX TUN 06.0006X	TÜV 04 ATEX 2679
IM31-22EX-U	IECEX TUN 06.0006X	TÜV 04 ATEX 2679
IM33-11EX-HI/24VDC	IECEX TUN 06.0001X	TÜV 00 ATEX 1595
IM33-12EX-HI/24VDC	IECEX TUN 06.0001X	TÜV 00 ATEX 1595
IM33-22EX-HI/24VDC	IECEX TUN 06.0001X	TÜV 00 ATEX 1595
IM34-11EX-CI	IECEX TUN 06.0010X	TÜV 02 ATEX 1898
IM34-11EX-I	IECEX TUN 06.0010X	TÜV 02 ATEX 1898
IM34-12EX-CRI	IECEX TUN 06.0010X	TÜV 02 ATEX 1898
IM34-12EX-RI	IECEX TUN 06.0010X	TÜV 02 ATEX 1898
IM34-14EX-CDRI	IECEX TUN 05.0014X	TÜV 02 ATEX 1898
IM35-11EX-HI/24VDC	Pending	TÜV 03 ATEX 2311
IM35-22EX-HI/24VDC	Pending	TÜV 03 ATEX 2311
IM72-11EX/L	IECEX TUN 05.0011X	TÜV 05 ATEX 2846
IM72-22EX/L	IECEX TUN 05.0011X	TÜV 05 ATEX 2846

Note:

UL Approvals are pending on all of the models listed here.
FM Approval Control Drawings are included on pages 86-91 in this guide.

FM Approved Isolator Barriers

Discrete Input Devices with Intrinsically Safe Field Circuits



NON-HAZARDOUS LOCATION, OR
Class I, Division 2, Groups A,B,C or D

HAZARDOUS (CLASSIFIED) LOCATION
Class I, Div. 1, Group A, B, C or D;
Class II, Div. 1, Group E, F or G;
Class III, Div. 1; or
Class I, Zone 0, 1 or 2, Group IIC, IIB or IIA

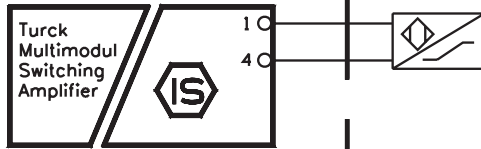

IM1 - a Ex - b
a = 12, or 121
b = R, T, or MT

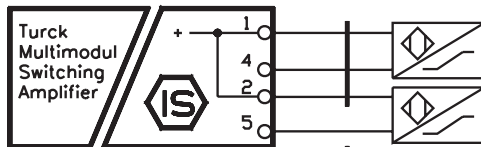

IM1 - 22Ex - b
IM12 - 22Ex - b
b = R, T, or MT

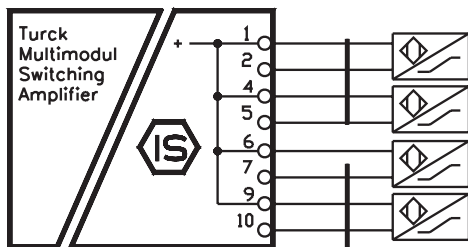

IM1 - c Ex - d
c = 44 or 451
d = R or T

Entity Parameters: Class I, Division 1; Class II, Division 1; Class III, Division 1
Circuit Characteristic: Linear

Model	Terminals	V _{oc} (V)	I _{sc} (mA)	P ₀ (mW)	C ₀ (uF) AB/CE/DFG	L ₀ (mH) AB/CE/DFG
IM1-12Ex-	1-4	9.6	11	27	3,6/26,0/210	250/922/1H
IM1-121Ex-						
IM1-22Ex-	1-4, 2-5	9.6	11	27	3,6/26,0/210	250/922/1H
IM12-22Ex-						
IM1-44Ex-	1-2, 4-5, 6-7, 9-10	11.5	12.8	37	1,6/11,2/46,0	222/781/1H
IM1-451Ex-						

Model	Terminals	V _t (V)	I _t (mA)	P ₀ (mW)	C ₀ (uF) AB/CE/DFG	L ₀ (mH) AB/CE/DFG
IM1-22Ex-	1-2-4-5	9.6	22	54	3,6/26,0/210	67/246/579
IM12-22Ex-						
IM1-44Ex-	1-2-4-5-6-7-9-10	11.5	51	147	1,6/11,2/46,0	12,5/49,0/108
IM1-451Ex-						

Entity Parameters: Class I, Zone 0, 1, or 2
Circuit Characteristic: Linear

Model	Terminals	U ₀ (V)	I ₀ (mA)	P ₀ (mW)	C ₀ (uF) IIC/IIB/IIA	L ₀ (mH) IIC/IIB/IIA
IM1-12Ex-	1-4	9.6	11	26	3,76/11,3/30,1	282/981/1H
IM1-121Ex-						
IM1-22Ex-	1-4, 2-5	9.6	11	26	3,76/11,3/30,1	282/981/1H
IM12-22Ex-						
IM1-22Ex-	1-2-4-5	9.6	22	54	3,6/26,0/210	67/246/579
IM12-22Ex-						
IM1-44Ex-	1-2, 4-5, 6-7, 9-10	11.5	12.8	37	1,6/11,2/46,0	222/781/1H
IM1-451Ex-						
IM1-44Ex-	1-2-4-5-6-7-9-10	11.5	51	147	1,6/11,2/46,0	12,5/49,0/108
IM1-451Ex-						

Notes:

- The symbol designates third party approved with correct entity parameters meeting the relations shown in Table 1.
 - For US jurisdictions - Any FM approved intrinsically safe apparatus with Entity Concept parameters, or any simple apparatus.
 - For Canadian jurisdictions - Any Canadian certified intrinsically safe apparatus with Entity Concept parameters, or any simple apparatus.

The Entity concept allows interconnection of intrinsically safe apparatus and associated apparatus not specifically examined in such combination as a system when the conditions above are met.

$$V_{max} \geq V_{oc} \text{ or } V_t \quad I_{max} \geq I_{sc} \text{ or } I_t \quad U_i \geq U_0 \quad I_i \geq I_0 \quad P_i \geq P_0$$

$$C_i + C_{cable} \leq C_0 \quad L_i + L_{cable} \leq L_0 \quad C_i + C_{cable} \leq C_0 \quad L_i + L_{cable} \leq L_0$$

A simple apparatus is defined as an electrical component or combination of components of simple construction with well-defined electrical parameters that does not generate more than 1.5V, 100mA, and 25mW, or a passive component that does not dissipate more than 1.3W and is compatible with the intrinsic safety of the circuit in which it is used.

- When the field device is a contact closure, the connection should be made as shown below for proper performance.

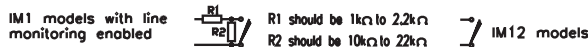

- Wiring methods must be in accordance with:
 - For US jurisdictions - the National Electrical Code, ANSI/NFPA 70, Article 504 (for Division installations) or Article 505 (for Zone applications), and ANSI/ISA RP12.06.01.
 - For Canadian jurisdictions - the Canadian Electrical Code, CSA 22.1, Appendix F.

- Associated apparatus must not be connected to any device that uses or generates in excess of 250Vrms.
- If the electrical parameters of the cable are unknown, the following values may be used:
Capacitance - 60pF/foot,
Inductance - 0.2uH/foot

Drawing No.: IS-1.101	TURCK 3000 Campus Drive Plymouth, MN 55441 Phone: (763) 553-7300
Title: Control Drawing for IM1-..Ex- and IM12-..Ex- Isolator Barriers with I/S (Entity) Field Circuits	
Scale: NONE	Sheet 1 of 1

A	Release	BVL	11/16/05
Rev	Description	Drft	Date

FM Approved Isolator Barriers

Discrete Output Devices with Intrinsically Safe Field Circuits



NON-HAZARDOUS LOCATION, OR
Class I, Division 2, Groups A,B,C,D

HAZARDOUS (CLASSIFIED) LOCATION
Class I, Div. 1, Group A,B,C or D; Class II, Div. 1, Group E,F or G; Class III, Div. 1
or
Class I, Zone 0, Group IIC, IIB, or IIA

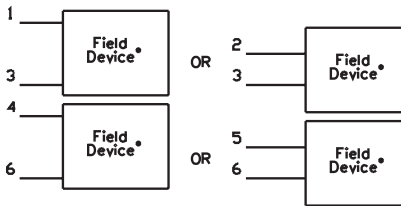
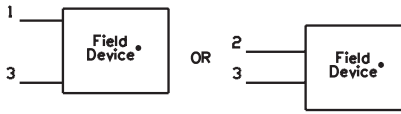
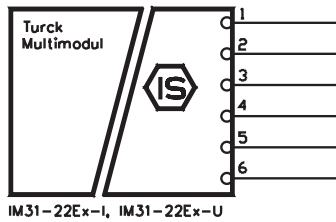
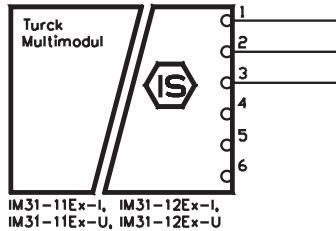

- The field device may be:
 - Any FM approved intrinsically safe apparatus with compatible Entity Concept parameters (see Note 1), or
 - Any Simple Apparatus (see Note 2).

Entity Parameters: Class I, Division 1; Class II, Division 1; Class III, Division 1
Output characteristic: Linear

Entity Parameters: Class I, Zone 0, 1, or 2
Output characteristic: Linear

Model	Terminals	V _{oc} (V)	I _{sc} (mA)	P _o (mW)	C _o (uF) AB/CE/DFG	L _o (H) ABCDEF
IM31-1,EX-	1-2-3	7.2	1	0.3	13.5/240/240	1
IM31-22EX-	1-2-3 4-5-6	7.2	1	0.3	13.5/240/240	1

Model	Terminals	U _o (V)	I _o (mA)	P _o (mW)	C _o (uF) IIC/IIB, IIA	L _o (mH) IIC, IIB, IIA
IM31-1,EX-	1-2-3	7.2	1	0.3	13.5/240	1
IM31-22EX-	1-2-3 4-5-6	7.2	1	0.3	13.5/240/240	1

Notes:

1. The entity concept allows interconnection of intrinsically safe apparatus and associated apparatus not specifically examined in combination as a system when the conditions below are met.

$$V_{max} \geq V_{oc} \text{ or } V_t \quad I_{max} \geq I_{sc} \text{ or } I_t \quad U_i \geq U_o \quad I_i \geq I_o \quad P_i \geq P_o$$

$$C_i + C_{cable} \leq C_o \quad L_i + L_{cable} \leq L_o \quad C_i + C_{cable} \leq C_o \quad L_i + L_{cable} \leq L_o$$

2. A simple apparatus is defined as an electrical component or combination of components of simple construction with well-defined electrical parameters that does not generate more than 1.5V, 100mA, and 25mW, or a passive component that does not dissipate more than 1.3W and is compatible with the intrinsic safety of the circuit in which it is used.

3. Wiring methods must be in accordance with:

For US jurisdictions - the National Electrical Code, ANSI/NFPA 70, Article 504 (for Division 1 or 2 installations) or Article 505 (for Zone 0, 1 or 2 applications), and ANSI/ISA RP12.06.01.

For Canadian jurisdictions - the Canadian Electrical Code, CSA 22.1, for Division 1 or 2 or Zone 1 or 2 installations.

4. Associated apparatus must not be connected to any device that uses or generates in excess of 250Vrms unless it has been determined that the voltage is adequately isolated from the associated apparatus.

5. If the electrical parameters of the cable are unknown, the following default values may be used:
Capacitance - 60pF/foot
Inductance - 0.2uH/foot

6. WARNING: Substitution of components may impair intrinsic safety. AVERTISSEMENT: La substitution de composants peut compromettre la securite intrinseque.

Drawing No: IS-1.114	TURCK 3000 Campus Drive Plymouth, MN 55441 Phone: (763) 553-7300
Title: Control Drawing for IM31-..Ex0-. with I/S (Entity) Field Circuits	
Scale: NONE	Sheet 1 of 1

A	Release	BVL	6/29/06
Rev	Description	Drft	Date

FM Approved Isolator Barriers

Analog Input Devices with Intrinsically Safe Field Circuits



NON-HAZARDOUS LOCATION, OR
Class I, Division 2, Groups A,B,C,D

HAZARDOUS (CLASSIFIED) LOCATION
Class I, Div. 1, Groups A,B,C,D; Class II, Div. 1, Groups E,F,G; Class III, Div. 1
or
Class I, Group IIC, IIB, or IIA, Zone per Note 1

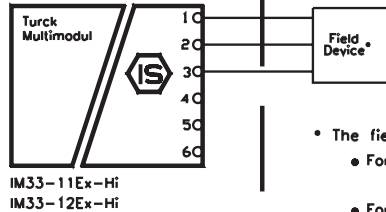

- * The field device may be:
 - For US jurisdictions - Any FM approved intrinsically safe apparatus with compatible Entity Concept parameters 1 or any simple apparatus 2.
 - For Canadian jurisdictions - Any Canadian certified intrinsically safe apparatus with compatible Entity Concept parameters 1 or any simple apparatus 2.

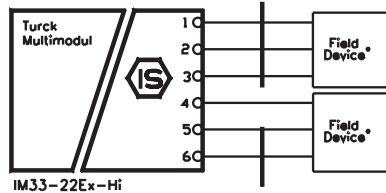

Entity Parameters: Class I, Division 1; Class II, Division 1; Class III, Division 1

Model	Terminals	V _{oc} (V)	I _{sc} (mA)	P _o (mW)	Output Characteristic	C _o (uF) AB/CE/DFG	L _o (mH) AB/CE/DFG
IM33-11Ex-... IM33-12Ex-...	1-2-3	21.2	89	472	Linear	0,18/01,24/4,68	4,5/17,3/35,9
IM33-22Ex-...	1-2-3, 4-5-6	21.2	89	472	Linear	0,18/01,24/4,68	4,5/17,3/35,9

Entity Parameters: Class I, Zone 0, 1, or 2

Model	Terminals	U _o (V)	I _o (mA)	P _o (mW)	Output Characteristic	C _o (uF) IIC/IIB/IIA	L _o (mH) IIC/IIB/IIA
IM33-11Ex-... IM33-12Ex-...	1-2-3	21.2	89	472	Linear	0,18/01,24/4,68	4,5/17,3/35,9
IM33-22Ex-...	1-2-3, 4-5-6	21.2	89	472	Linear	0,18/01,24/4,68	4,5/17,3/35,9

Notes:

1. The entity concept allows interconnection of intrinsically safe apparatus and associated apparatus not specifically examined in combination as a system when the conditions below are met.

$$V_{max} \geq V_{oc} \text{ or } V_t \quad I_{max} \geq I_{sc} \text{ or } I_t \quad U_i \geq U_o \quad I_i \geq I_o \quad P_i \geq P_o$$

$$C_i + C_{cable} \leq C_o \quad L_i + L_{cable} \leq L_o \quad C_i + C_{cable} \leq C_o \quad L_i + L_{cable} \leq L_o$$

2. A simple apparatus is defined as an electrical component or combination of components of simple construction with well-defined electrical parameters that does not generate more than 1.5V, 100mA, and 25mW, or a passive component that does not dissipate more than 1.3W and is compatible with the intrinsic safety of the circuit in which it is used.

3. Wiring methods must be in accordance with:

For US jurisdictions - the National Electrical Code, ANSI/NFPA 70, Article 504 (for Division 1 or 2 installations) or Article 505 (for Zone 0, 1 or 2 applications), and ANSI/ISA RP12.06.01.

For Canadian jurisdictions - the Canadian Electrical Code, CSA 22.1, for Division 1 or 2 or Zone 1 or 2 installations.

4. Associated apparatus must not be connected to any device that uses or generates in excess of 250Vrms unless it has been determined that the voltage is adequately isolated from the associated apparatus.

5. If the electrical parameters of the cable are unknown, the following default values may be used:

Capacitance - 60pF/foot
Inductance - 0.2uH/foot

6. WARNING: Substitution of components may impair intrinsic safety. AVERTISSEMENT: La substitution de composants peut compromettre la securite intrinseque.

Drawing No: IS-1.102	TURCK 3000 Campus Drive Plymouth, MN 55441 Phone: (763) 553-7300
Title: Control Drawing for IM33-..Ex-., with I/S (Entity) Field Circuits	
Scale: NONE	Sheet 1 of 1

A	Release	BVL	11/22/05
Rev	Description	Drft	Date

FM Approved Isolated Amplifiers
Temperature Transmitters with Intrinsically Safe Field Circuits



NON-HAZARDOUS LOCATION, OR
Class I, Division 2, Groups A,B,C,D

HAZARDOUS (CLASSIFIED) LOCATION
Class I, Div. 1, Groups A,B,C,D; Class II, Div. 1, Groups E,F,G; Class III, Div. 1
or
Class I, Group IIC, IIB, or IIA, Zone per Note 3

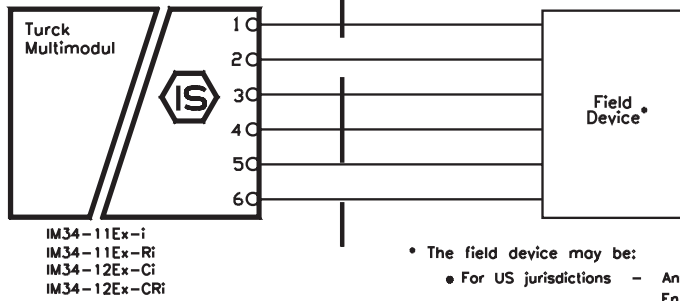

- * The field device may be:
 - For US jurisdictions - Any FM approved intrinsically safe apparatus with compatible Entity Concept parameters $\triangle 1$ or any simple apparatus $\triangle 2$.
 - For Canadian jurisdictions - Any Canadian certified intrinsically safe apparatus with compatible Entity Concept parameters $\triangle 1$ or any simple apparatus $\triangle 2$.

Entity Parameters: Class I, Division 1; Class II, Division 1; Class III, Division 1

Model	Terminals	V _t (V)	I _t (mA)	P ₀ (mW)	Output Characteristic	C ₀ (uF) AB/CDEFG	L ₀ (mH) AB/CDEFG
IM34-11Ex0-i	1-2-3-4-5-6	5	7.6	9.5	Linear	100/1000	500/1H
IM34-12Ex0-Ri	1-2-3-4-5-6						
IM34-11Ex0-Ci	1-2-3-4-5-6						
IM34-12Ex0-CRi	1-2-3-4-5-6						

Entity Parameters: Class I, Zone 0, 1, or 2

Model	Terminals	U ₀ (V)	I ₀ (mA)	P ₀ (mW)	Output Characteristic	C ₀ (uF) IIC/IIB/IIA	L ₀ (mH) IIC/IIB/IIA
IM34-11Ex0-i	1-2-3-4-5-6	5	7.6	9.5	Linear	100/1000/1000	500/1H/1H
IM34-12Ex0-Ri	1-2-3-4-5-6						
IM34-11Ex0-Ci	1-2-3-4-5-6						
IM34-12Ex0-CRi	1-2-3-4-5-6						

Notes:

$\triangle 1$ The entity concept allows interconnection of intrinsically safe apparatus and associated apparatus not specifically examined in combination as a system when the conditions below are met.

$$V_{max} \geq V_{oc} \text{ or } V_t \quad I_{max} \geq I_{sc} \text{ or } I_t \quad U_i \geq U_o \quad I_i \geq I_o \quad P_i \geq P_o$$

$$C_i + C_{cable} \leq C_o \quad L_i + L_{cable} \leq L_o \quad C_i + C_{cable} \leq C_o \quad L_i + L_{cable} \leq L_o$$

2. A simple apparatus is defined as an electrical component or combination of components of simple construction with well-defined electrical parameters that does not generate more than 1.5V, 100mA, and 25mW, or a passive component that does not dissipate more than 1.3W and is compatible with the intrinsic safety of the circuit in which it is used.

$\triangle 3$ Wiring methods must be in accordance with:

For US jurisdictions - the National Electrical Code, ANSI/NFPA 70, Article 504 (for Division 1 or 2 installations) or Article 505 (for Zone 0, 1 or 2 applications), and ANSI/ISA RP12.06.01.

For Canadian jurisdictions - the Canadian Electrical Code, CSA 22.1, for Division 1 or 2 or Zone 1 or 2 installations.

4. Associated apparatus must not be connected to any device that uses or generates in excess of 250Vrms unless it has been determined that the voltage is adequately isolated from the associated apparatus.

5. If the electrical parameters of the cable are unknown, the following default values may be used:

Capacitance - 60pF/foot
Inductance - 0.2uH/foot

6. WARNING: Substitution of components may impair intrinsic safety. AVERTISSEMENT: La substitution de composants peut compromettre la securite intrinseque.

Drawing No: IS-1.106	TURCK 3000 Campus Drive Plymouth, MN 55441 Phone: (763) 553-7300
Title: Control Drawing for IM34-11Ex-., with I/S (Entity) Field Circuits	
Scale: NONE	Sheet 1 of 1

A	Release	BVL	11/22/05
Rev	Description	Drft	Date

FM Approved Isolator Barriers
Analog Output Devices with Intrinsically Safe Field Circuits



NON-HAZARDOUS LOCATION, OR
Class I, Division 2, Groups A,B,C,D

HAZARDOUS (CLASSIFIED) LOCATION
Class I, Div. 1, Groups A,B,C,D; Class II, Div. 1, Groups E,F,G; Class III, Div. 1
OR
Class I, Group IIC, IIB, or IIA, Zone per Note \triangle

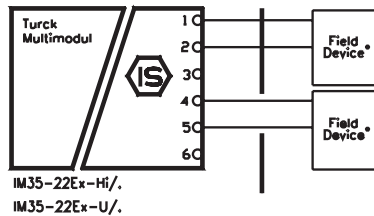
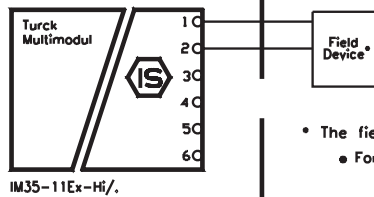

- * The field device may be:
- For US jurisdictions - Any FM approved intrinsically safe apparatus with compatible Entity Concept parameters \triangle , or any simple apparatus \triangle .
 - For Canadian jurisdictions - Any Canadian certified intrinsically safe apparatus with compatible Entity Concept parameters \triangle , or any simple apparatus \triangle .

Entity Parameters: Class I, Division 1; Class II, Division 1; Class III, Division 1

Model	Terminals	V _{oc} (V)	I _{sc} (mA)	P _o (mW)	Output Characteristic	R _i (Ohms)	C _o (uF) AB/CDEFG	L _o (mH) AB/CDEFG
IM35-11Ex-Hi/.	1-2	15.9	60	500	Trapezoidal	527	0.15/0.3	1/25
IM35-22Ex-Hi/.	1-2, 4-5	15.9	60	500	Trapezoidal	527	0.15/0.3	1/25
IM35-22Ex-U/.	1-2, 4-5	15.9	60	500	Trapezoidal	527	0.15/0.3	1/25

Entity Parameters: Class I, Zone 0, 1, or 2

Model	Terminals	U _o (V)	I _o (mA)	P _o (mW)	Output Characteristic	R _i (Ohms)	C _o (uF) IIC/IIB/IIA	L _o (mH) IIC/IIB/IIA
IM35-11Ex-Hi/.	1-2	15.9	60	500	Trapezoidal	527	0.15/0.3/0.3	1/25/25
IM35-22Ex-Hi/.	1-2, 4-5	15.9	60	500	Trapezoidal	527	0.15/0.3/0.3	1/25/25
IM35-22Ex-U/.	1-2, 4-5	15.9	60	500	Trapezoidal	527	0.15/0.3/0.3	1/25/25

Notes:

\triangle The entity concept allows interconnection of intrinsically safe apparatus and associated apparatus not specifically examined in combination as a system when the conditions below are met.

$$V_{max} \geq V_{oc} \text{ or } V_t \quad I_{max} \geq I_{sc} \text{ or } I_t \quad U_i \geq U_o \quad I_i \geq I_o \quad P_i \geq P_o$$

$$C_i + C_{cable} \leq C_o \quad L_i + L_{cable} \leq L_o \quad C_i + C_{cable} \leq C_o \quad L_i + L_{cable} \leq L_o$$

\triangle A simple apparatus is defined as an electrical component or combination of components of simple construction with well-defined electrical parameters that does not generate more than 1.5V, 100mA, and 25mW, or a passive component that does not dissipate more than 1.3W and is compatible with the intrinsic safety of the circuit in which it is used.

3. Wiring methods must be in accordance with:

For US jurisdictions - the National Electrical Code, ANSI/NFPA 70, Article 504 (for Division 1 or 2 installations) or Article 505 (for Zone 0, 1 or 2 applications), and ANSI/ISA RP12.06.01.

For Canadian jurisdictions - the Canadian Electrical Code, CSA 22.1, for Division 1 or 2 or Zone 1 or 2 installations.

4. Associated apparatus must not be connected to any device that uses or generates in excess of 250Vrms unless it has been determined that the voltage is adequately isolated from the associated apparatus.

5. If the electrical parameters of the cable are unknown, the following default values may be used:
Capacitance - 60pF/foot
Inductance - 0.2uH/foot

6. WARNING: Substitution of components may impair intrinsic safety. AVERTISSEMENT: La substitution de composants peut compromettre la securite intrinseque.

Drawing No: IS-1.105	TURCK 3000 Campus Drive Plymouth, MN 55441 Phone: (763) 553-7300
Title: Control Drawing for IM35-..Ex-Hi and IM35-..Ex-U with I/S (Entity) Field Circuits	
Scale: NONE	Sheet 1 of 1

A	Release	BVL	11/22/05
Rev	Description	Drft	Date

Discrete Output Devices with Intrinsically Safe Field Circuits



NON-HAZARDOUS LOCATION, OR
Class I, Division 2, Groups A,B,C,D

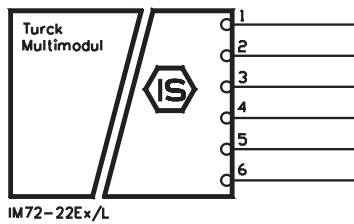
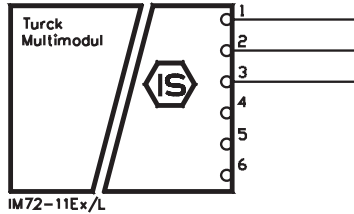

HAZARDOUS (CLASSIFIED) LOCATION
Class I, Div. 1, Group A,B,C or D; Class II, Div. 1, Group E,F or G; Class III, Div. 1
or
Class I, Zone 0, Group IIC, IIB, or IIA

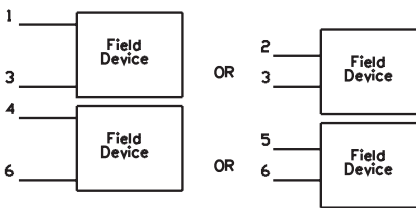
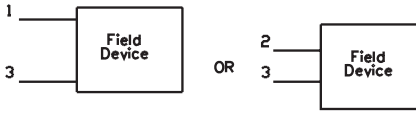

- The field device may be:
 - Any FM approved intrinsically safe apparatus with compatible Entity Concept parameters (see Note 1), or
 - Any Simple Apparatus (see Note 2).

Entity Parameters: Class I, Division 1; Class II, Division 1; Class III, Division 1
Output characteristic: Trapezoidal (R_i = 297 Ohms)

Model	Terminals	V _{oc} (V)	I _{sc} (mA)	P _o (mW)	C _o (uF) AB/CDEFG	L _o (mH) AB/CDEFG
IM72-11EX/L	1-3	27	95.3	674	0.03/0.15	2/5
IM72-11EX/L	2-3	17.5	95.3	674	0.10/0.30	1/10
IM72-22EX/L	1-3, 4-6	27	95.3	674	0.03/0.15	2/5
IM72-22EX/L	2-3, 5-6	17.5	95.3	674	0.10/0.30	1/10

Entity Parameters: Class I, Zone 0, 1, or 2
Output characteristic: Trapezoidal (R_i = 297 Ohms)

Model	Terminals	U _o (V)	I _o (mA)	P _o (mW)	C _o (uF) IIC/IIB,IIA	L _o (mH) IIC/IIB,IIA
IM72-11EX/L	1-3	27	95.3	674	0.03/0.15	2/5
IM72-11EX/L	2-3	17.5	95.3	674	0.10/0.30	1/10
IM72-22EX/L	1-3, 4-6	27	95.3	674	0.03/0.15	2/5
IM72-22EX/L	2-3, 5-6	17.5	95.3	674	0.10/0.30	1/10

Notes:

1. The entity concept allows interconnection of intrinsically safe apparatus and associated apparatus not specifically examined in combination as a system when the conditions below are met.

$$V_{max} \geq V_{oc} \text{ or } V_t \quad I_{max} \geq I_{sc} \text{ or } I_t \quad U_i \geq U_o \quad I_i \geq I_o \quad P_i \geq P_o$$

$$C_i + C_{cable} \leq C_o \quad L_i + L_{cable} \leq L_o \quad C_i + C_{cable} \leq C_o \quad L_i + L_{cable} \leq L_o$$

2. A simple apparatus is defined as an electrical component or combination of components of simple construction with well-defined electrical parameters that does not generate more than 1.5V, 100mA, and 25mW, or a passive component that does not dissipate more than 1.3W and is compatible with the intrinsic safety of the circuit in which it is used.

3. Wiring methods must be in accordance with:

For US jurisdictions - the National Electrical Code, ANSI/NFPA 70, Article 504 (for Division 1 or 2 installations) or Article 505 (for Zone 0, 1 or 2 applications), and ANSI/ISA RP12.06.01.

For Canadian jurisdictions - the Canadian Electrical Code, CSA 22.1, for Division 1 or 2 or Zone 1 or 2 installations.

4. Associated apparatus must not be connected to any device that uses or generates in excess of 250Vrms unless it has been determined that the voltage is adequately isolated from the associated apparatus.

5. If the electrical parameters of the cable are unknown, the following default values may be used:

Capacitance - 60pF/foot
Inductance - 0.2uH/foot

6. WARNING: Substitution of components may impair intrinsic safety. AVERTISSEMENT: La substitution de composants peut compromettre la securite intrinseque.

Drawing No: IS-1.108	TURCK 3000 Campus Drive Plymouth, MN 55441 Phone: (763) 553-7300
Title: Control Drawing for IM72-..Ex0/L with I/S (Entity) Field Circuits	
Scale: NONE	Sheet 1 of 1

A	Release	BVL	6/21/06
Rev	Description	Drft	Date

Register to receive the TURCK TIMES ...

Our interactive e-newsletter full of exclusive insights, tips and tools to help make your manufacturing processes run smoothly. The TURCK Times is your source for news about TURCK products and industry updates.

Registering is easy and only requires your e-mail address. You are not obligated for future contact or purchase, and you may opt-in or out of the e-mail list at any time! We value your time and privacy, and will not share your information with another party.

Sign up today at www.turck.com/elist!



Industrial Automation

www.turck.com

TURCK TIMES

WHAT'S NEW?

The **versafast™** line now includes standard and shielded 12-pin field wireables.

versafast connectors are excellent for food and beverage, pharmaceutical and material handling industries. They are also commonly used with encoders and other measurement devices.



Issue 2 | July 2006





New dual discrete and discrete/analog versions for **Digital Read Out (DRO)** flow monitors. **DRO** flow monitors are used to monitor flow and temperature. They are easy to program, and feature a highly visible display.

DID YOU KNOW? Implementing cabled systems offer a simpler, less labor intensive installation, accelerating project cycle times. ITC rated cable with quick disconnects has resulted in up to 45 percent savings for several **TURCK** customers, with the majority of these savings coming from installation and commissioning. Utilizing cabled systems also eliminates the need to seal conduit which can also improve maintenance and installation time and reduce errors. [Learn more about ITC rated cables.](#)

TIPS FROM TURCK

A new search tool on [TURCK's U.S. web site](#) gives you easy access catalog pages, CAD files, data sheets, pictures and much more. Wildcard options expedite the search process, for example:

*G18*7M*	Finds all products with both 'G18' and '7M' in the part number.
Q08	Finds all products with 'Q08' in the number, regardless of its location.
*S100	Finds all products that end in 'S100'.

WHITE PAPERS / ARTICLES

DIE PROTECTION FOR METAL STAMPING OPERATIONS.
The number one reason for unexpected downtime or nonconforming parts in metal stamping applications is die crashes. Eliminating die crashes helps control repair processes and improves press time and production scheduling. This paper describes how and where sensors are implemented

Next issue...

Unraveling the complexities of level detection.

The pros and cons of using DeviceNet and Ethernet in industrial environments.

NEW PRODUCT: Completely shielded M23 **multifast®** cordsets.

We want to hear from you!

Do you have:

- Tips or best practices to share?
- Information you'd like to know?
- Questions about **TURCK** products?
- Suggestions for this e-newsletter?

Just send us an [e-mail!](#) We'd be happy to share your stories or tips, and answer your questions.

TURCK

Interface Technology

TURCK Inc. sells its products through Authorized Distributors. These distributors provide our customers with technical support, service and local stock. **TURCK** distributors are located nationwide - including all major metropolitan marketing areas.

For Application Assistance or for the location of your nearest **TURCK** distributor, call:

1-800-544-7769

Specifications in this manual are subject to change without notice. **TURCK** also reserves the right to make modifications and makes no guarantee of the accuracy of the information contained herein.

Literature and Media questions or concerns?

Contact Marketing Communications **TURCK** USA - media@turck.com

AT TURCK, WE THINK HAZARDOUS AREA CONTROL SHOULD BE A WHOLE LOT EASIER.



Designing safety into potentially explosive areas can be a challenge. At **TURCK**, we've made the problem a whole lot easier with our line of intrinsically safe sensors and interface devices.

Rather than trying to build a fortress around the hazard, our advanced technology simply prevents ignition by limiting the thermal and electrical energy to the hazardous area. Not only is it technologically superior, it's also easier to engineer, install and maintain – saving you time and money.

TURCK controls have proven themselves in the petro-chemical industry and meet Factory Mutual requirements for Class I, Class II and Class III, Division 1 and Division 2 environments. They easily interface to PLCs, and can provide advanced intelligence to monitor speed, temperature, pressure and other variables.

....**Sense It!**....**Connect It!**....**Bus It!**

TURCK *works*

Industrial Automation



www.turck.com

With **TURCK** intrinsically safe devices:

- Use lower cost, less bulky standard enclosures.
- Eliminate most cable seals and explosion-proof conduit.
- Easily modify your system.
- Test your system live (hot).

FM approved for Class I, II and III,
Divisions 1 and 2.

TURCK Inc.
3000 Campus Drive
Minneapolis, MN 55441
Phone: 763-553-7300
Fax: 763-553-0708
www.turck.com

1-800-544-7769

....Sense It!....Connect It!....Bus It!

Access to all TURCK catalogs, press releases, white papers and tutorials

Search for products by part number, ID number or key word

Complete category listing of TURCK products

Access to CAD, wiring and pinout diagrams

Download or e-mail files, request for quote

Option to e-mail pages
Contact a TURCK representative

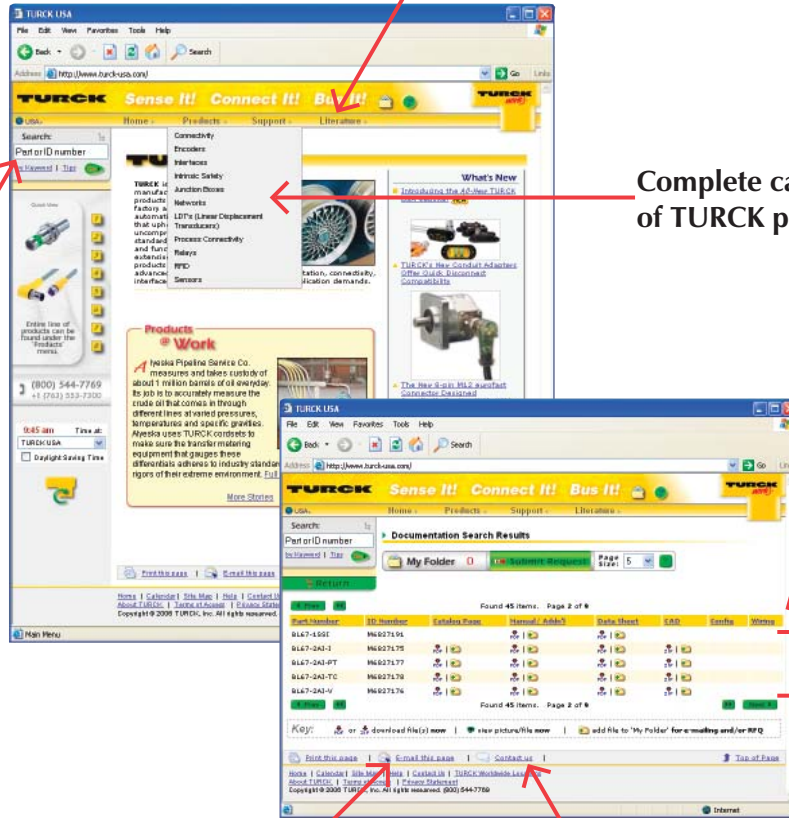

TURCK's USA website is your most complete and up-to-date source for product documentation, CAD files and more. Search results produce downloadable documentation or request for quote (RFQ). Additional product information or CAD files are easily requested and promptly filled.

Visit our site for new product releases, approvals, white papers, application support and more.

www.turck.com

3000 Campus Drive
Minneapolis, MN 55441
Phone: 1-800-553-0016
FAX: (763) 553-0706
Application Support:
1-800-544-7769